

Acknowledged

A Perspective on the Matters of
UFOs, Aliens and Crop Circles

Andrew Johnson

Book details:

Acknowledged: A Perspective on UFOs, Aliens and Crop Circles

by Andrew Johnson

Self-Published – Mar 2019

ISBN-13: 9781726690911

Front Cover Design by Peter Lomas

<https://art-of-the-soul.blogspot.com/>

Back Cover Image: [Tadpole Galaxy \(UGC 10214\)](#)¹

Reference List: <http://www.checktheevidence.com/apuacc.html>

No Wikipedia links included!

(Wikipedia censors important information in real-time – use it at your peril!)

Use of Images

No copyright infringement or misuse of images is intended in this book, which is designed to educate and enlighten, using criticism and analysis. A version of this book will be given away as a free download. However, if you find an image in this book you are concerned about, please contact me and if you feel uncomfortable giving me permission, I will certainly remove it, if that is your wish. Thank you for your understanding!

Between the people and government today lies a double standard of morality. Anything remotely scientific has become by government definition a matter of military security first; hence of secrecy, something which does not breed security but fear. If we see anything unusual, even in the skies, we the people must either freeze our lips, like a Russian peasant at the sight of a commissar, or give our names, addresses, business connections, and testimony to be screened and filtered by anonymous intelligence officers. Feared and respected by many people, these anonymous creatures can deny what we say, ridicule what we say, and sometimes (and in an increasing number of countries) jail us for what we say especially if our timing does not match to the second their intended official pronouncements on the subject.

-- Frank Scully – Behind the Flying Saucers – Preface – 1950

Dedications

This book is dedicated to my friend **Lloyd Pye**, who died from Lymphoma Cancer on 9th Dec 2013. He is sorely missed, both as a friend, and as a diligent and sincere researcher, author and authoritative and enthusiastic speaker.

Acknowledgements

Thanks to everyone that has helped in developing this research and to those who make the information, herein, freely available.

Special Acknowledgements

- Richard D Hall
- Travis Walton
- Alan Godfrey
- Colin Andrews
- Lucy Pringle
- Nancy Talbot and BLT Research
- David Cayton
- Dr Judy Wood

Important Researchers Quoted

- Dr Steven Greer
- Scott Ramsey
- Zechariah Sitchin
- Bill Cooper
- Robert Temple
- Lloyd Pye

Author Biography



Andrew Johnson grew up in Yorkshire and graduated from Lancaster University in 1986 with a degree in Computer Science and Physics. He worked in Software Engineering and Software Development, for about 20 years. He has also worked full and part time in lecturing and tutoring and he now works for the Open University (part time) tutoring students, whilst occasionally working on various small software development projects. He became interested in “alternative knowledge” in 2003,

soon after discovering Dr Steven Greer’s Disclosure Project. Andrew has given presentations and written and posted many articles on various websites about 9/11, Mars, Chemtrails and Antigravity research, whilst also challenging some of the authorities to address some of the data he and others have collected.

Andrew is married and has two children. You can email Andrew Johnson on ad.johnson@ntlworld.com.

His website is www.checktheevidence.com.

Other Books by Andrew Johnson

These are available as PDF downloads, as well as other formats:

Climate Change and Global Warming... Exposed: Hidden Evidence, Disguised Plans (ISBN: 978-1976209840)

This book collects together, for the first time anywhere, a range of diverse data which proves that the whole issue of “climate change” is more complicated and challenging than almost all researchers are willing to consider, examine, or entertain. For example, this book contains astronomical data which most climatologists will not discuss in full. Similarly, the book contains climate and weather data that astronomers will not discuss. The book contains some data that neither astronomers nor climatologists will discuss. It contains some data that no scientists will appropriately discuss. It will show the reader why the climate change/global warming scam was invented, and it will illustrate how the scam has been implemented.

Secrets in the Solar System: Gatekeepers on Earth (ISBN: 978-1981117550)

Since 1957, robotic space probes have visited all the planets in the Solar System. Is it the case that they have only found mostly uninteresting collections of gas, rocks, ice and dust? Has any evidence of past or present life in the Solar System ever been discovered?

This book will take you “on a journey” to the Sun and the Moon, Mars, Phobos, Saturn and some of its moons. It will show you some of the numerous anomalies that have been found. Could it be the case that taxpayer-funded space agencies have ignored or even lied about these anomalies, and their significance?

After more than 10 years of ongoing research, collected together here, for the first time anywhere, are over 350 fully-referenced pictures and data from over 50 years of space missions. Anomalous images are presented with some detailed explanations, commentary and analysis, completed by various researchers. The book asks what would happen if NASA or ESA scientists had discovered compelling evidence of past or present extra-terrestrial life in the Solar System? Would they “tell us the truth, the whole truth and nothing but the truth” about such a discovery? Or, would the “scientific technological elite” mentioned in Eisenhower’s final address to the USA in 1961, become the “gatekeepers” of “Secrets in the Solar System?”

9/11 Finding the Truth (ISBN: 978-1548827618)

What really happened on 9/11? What can the evidence tell us? Who is covering up the evidence, and why are they covering it up? This book attempts to give some answers to these questions and has been written by someone who has become deeply involved in research into what happened on 9/11. A study of the available evidence will challenge you and much of what you assumed to be true.

9/11 Holding the Truth (ISBN: 978-1979875981)

The truth about what happened to the World Trade Centre on 11 September 2001 was discovered by Dr Judy Wood, through careful research between 2001 and 2008. The author of this book, Andrew Johnson, had a “good view” of how later parts of Dr Wood’s research “came together.” Not only that, he was also involved in activities, correspondence and research which illustrated that this truth was being deliberately covered up. This book is a companion and follow-up volume to “9/11 Finding the Truth” – and documents ongoing (and successful) efforts to keep the truth out of the reach of most of the population. Evidence in this book, gathered over a period of 12 years, shows that the cover up is “micro-managed,” internationally and even globally. The book names people who are involved in the cover up. It illustrates how they often stick to “talking points” and seem to have certain patterns of behaviour. It attempts to illustrate how difficult it is to prevent the truth from being marginalised, attacked and “muddled up.”

Finding the Secret Space Programme: Removing Truth’s Protective Layers

The “Space Age” began in 1957 and since then, we are told, missions have studied all the planets in the Solar System. Most people believe that one of the greatest technological achievements happened in 1969, when Neil Armstrong allegedly walked on the surface of the Moon. The last Apollo mission ended in 1972 and later manned space missions never travelled beyond low earth orbit, despite enormous advances in many technologies.

This book considers the works of Dr Paul La Violette and Defence Journalist Nick Cook regarding antigravity research in the aerospace industry and elsewhere. It analyses the statements of certain whistle-blowers, who claim to have worked on covert propulsion and energy technology programmes. The Apollo programme and its background are also studied in some depth, along with claims and statements made by some of the Apollo astronauts.

Is it true that exotic propulsion technologies have been successfully developed and deployed, as part of a secret space programme - and comprehensively hidden from public view, using sophisticated methods?

After more than 14 years of ongoing research, collected together here, probably for the first time anywhere, are referenced images, quotes analysis and commentary. A study of this evidence should help us to remove what Neil Armstrong referred to as “Truth’s Protective Layers.”

Table of Contents

Preface and Introduction	9
Part I UFOs and Aliens	11
1. A Developing Interest and Four Sightings.....	12
2. UFO/ET Perceptions	18
3. UFO/ETs in Songs and Cinema.....	34
4. UFOs? Aliens? Do Me a Favour, Ha!.....	50
5. UFO/ET Landings and Crashes	62
6. Some Video Evidence and Some Powerful Witness Testimony	83
7. Wilbert B Smith - from Sceptic to Contactee.....	101
8. More Contactees	117
9. Abductions and Abductees.....	138
10. The Interrupted Journey.....	140
11. Taken Up?	146
12. Leah Haley and Stan Romanek	160
13. Budd Hopkins and A Bizarre New York City Abduction Case	172
14. Analysing Alien Abductions	179
15. AFB Landings and Presidential Close Encounters?.....	192
16. DUMBs, Dulce and Cattle Mutilations.....	201
17. Ancient Aliens (and Ancient Civilisations).....	216
18. Robert Temple – The Sirius Mystery	220
19. Zechariah Sitchin, The Twelfth Planet and the Creation of Humans	230
20. Alien Races...? Alien Faces...?	251
21. The Starchild Skull and Lloyd Pye.....	265
22. Perception Management of the Starchild Skull Evidence	272
23. Dr. Steven Greer – “Going Critical”.....	288
24. Limited Hangouts? Disinformation?	306
Part II A Mystery in the Fields.....	319
25. Introduction and Overview of Crop Formations.....	320
26. Some Researchers and Some Research	333
27. Plankers and Stompers	343
28. Phenomena Associated with Crop Formation Appearance.....	350
29. Microwave Energy, Operation Blackbird, and Crop Formations.....	364
30. Crop Formation - Symbolism and Messages.....	368
31. Energy Effects and Residual Effects in Crop Formations and Elsewhere.....	388
32. Crop Circle Technology - and Cover Up.....	400
33. Crop Circle Conclusions	407
Part III Some Final Thoughts.....	409
34. Discovery, not Disclosure... ..	410

Preface and Introduction

Why This Book Exists

This book is a compilation and distillation of ongoing research into UFOs, Aliens and Crop Circles. The title of the book is inspired by the title of a book by Dr Steven Greer – “Unacknowledged.” (We will learn more about Dr Greer later.)

This is not what I would call a “beginner’s” book on these phenomena. It is aimed at an audience who are familiar with one or more of the topics listed in the title and are interested in reading a, perhaps, different perspective on how these seem to fit into a wider picture, ultimately controlled by established global interests.

This book, like my other books, will also discuss the activities of a few well-known researchers and speakers. It will go over certain key things they have discussed and some things they have not discussed.

Those people who have read articles or watched the presentations I have given since about 2008 will be familiar with most or all of the contents of this book. I have simply decided to compile a single volume using the information I have gathered over the years. It also gives me a way of reviewing what I have studied and learned in the last 15 years or so. I hope that it represents a synthesis of something useful, which will enlighten the reader in one or more ways and help to “join together” some topics in ways they had not thought of previously.

Rehashing Old Stuff?

For the knowledgeable reader and researcher, there probably isn’t much new information in this book – most of the cases and evidence I have referred to have been written about more thoroughly elsewhere (I will include, at the appropriate points, references to further discussion for the interested reader to follow up). So why should you read this book? One reason is that I have, as in my other books, tried to offer a “more informed analysis” of the evidence available, due to observations I have made as I have researched all these topics. Certain patterns of evidence – and behaviour have become apparent to me and there are certain key areas that some researchers do not seem willing to consider or discuss. Without discussion of these areas, it is not possible to gain the same level of understanding of “what is going on in the wider scheme of things.” In later sections of this book, I include some information about the activities of *researchers* to try and illuminate what their motives might be.

Readers of my other books will probably have a very good idea of what I am alluding to. I will be examining some of the stated topics, where relevant, in the context of what happened on 9/11. That is to say, the group or groups that organised and perpetrated the atrocities of 9/11 (and also organised and continue to run the cover up of these events) are extremely powerful. Hence,

it is most likely that those groups also know the most about the topics mentioned in the title of this book. Indeed, I will attempt to illustrate that, based on available evidence, this must be the case. In other words, the group or groups that are “running” the cover up of 9/11 are also running the UFO cover up – and know a lot more than we do about things that have been going on. They have agents, operating within most or all of the special interest groups of any size. These groups, then, are helping (often inadvertently) to keep certain key parts of the cover up in place, whilst perhaps, revealing some important/truthful information too.

It seems to me that knowledge of the reality of non-human intelligence (call them aliens if you like) interacting with humans and human affairs over a long period of time is a crucially important issue. Great expense and effort have been expended to cover up and muddle up most or all of the evidence which would give us a better understanding of who we really are, where we came from and why the world is like it is. I contend that the cover up can only be neutralised by each of us gaining a better understanding and knowledge of the truth about these issues and how the cover up itself is maintained. When you know what is being covered up (at least, to some extent) and how it is being covered up, it is then harder for you to be controlled and exploited by those interests that are, indeed, relying either on your ignorance or they are relying on you having (or not having) certain beliefs. The situation where those who *know* certain things control those who *believe* certain things has existed for centuries.

Being Selective?

It is undoubtedly rather unrealistic to think that, concerning my “chosen topics,” I can cover all the relevant material in a single volume such as this. There may be cases which the reader is aware of which I don’t even mention, or other cases that I don’t seem to cover in enough detail. This may not be for any other reason than I have simply chosen to spend more time on cases I have learned more about.

References

On finishing the book, I had a list of over 900 references. This list would have filled about 20 additional pages. You can access the list of references using this link:

<http://www.checktheevidence.com/apuacc.html>

Part I

UFOs and Aliens

1. A Developing Interest and Four Sightings

Children's Books

I have been interested in the subject of UFOs and the Paranormal since I was a child. Yes, I watched all the usual Sci-Fi films and TV series too! From the age of about 8, I have also been interested in Astronomy and space exploration. When I was 8 or 9 or 10, I was given the book whose cover is shown below

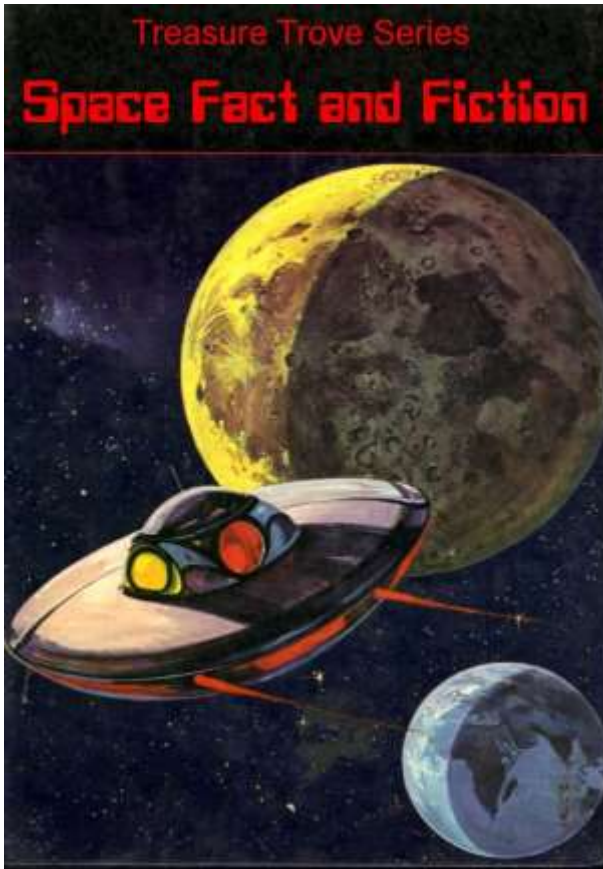

This was a 45-page hardback book I was given at the age of about 9 or 10. (Published by Harper Collins in 1972. Written by Mollie Bowen, Illustrated by Gerald Wood.) This book had some facts about things like the Yuri Gagarin mission, but it also covered the Thomas Mantell UFO case (with a wonderful illustration) and the George Adamski case. (A [blog](#) described an earlier edition of this book thus: “This book mixed the UFO speculation with chapters about the actual space flight efforts. Nice paintings though.”²)

I was also given a Hardback Astronomy Book by Iain Nicolson which was a little longer. Similarly, I was given a small, single-volume children's encyclopaedia called “Why? What? Where?” which had articles about volcanoes and dinosaurs.

My casual interest was maintained throughout my formative years, as my eldest brother used to get magazines occasionally such as “Omni” and these would sometimes carry UFO/ET-related stories.

When I was 17, I started ‘A’ Levels in Maths, Physics, Chemistry and General Studies and as part of the latter subject, we had to do a written project of our

own choosing. I chose a project title of “Close Encounters of the Extraterrestrial Kind – Hallucination, Imagination or Fact?” This project was completed between 1982 and 1983 and ended up being about 20 or 25 sides of A4 paper (handwritten!) I included several photographs and a few drawings. (I didn’t have any access to word processing facilities at school or at home back then!)

Soon after I’d started my project, my English teacher, Mr Jones, spoke to me and said that I should meet his neighbour. Mr Jones said to me “He’s got the weirdest stories...” Mr Jones looked troubled as he said this, because he realised his neighbour was a serious-minded person – a police officer. Mr Jones, I think, also realised that there must be some truth to the stories that his neighbour related to him. This police officer was none other than Tony Dodd, who was later to author [the book “Alien Investigator.”](#)³ Sadly, [Tony passed on in 2009](#)⁴, after suffering with a brain tumour.

One evening in 1982 or 1983, I met with Tony at his house in Skipton and he related a number of cases to me, including his own sighting of a 100-foot wide glowing craft which flew over his head, when he was on duty with his colleague on 12 December 1978. (This case is described on [a page on Colin Andrews’ website](#)⁵.) At another time, Tony Dodd told me he had signalled to a craft with his torch, and the craft signalled back to him. Tony gave me information on a contact case he was investigating at the time and he also gave me details of the [Zigmund Adamski case from 1980](#)⁶. Tony Dodd was widely respected and it was unfortunate that our paths never crossed in my adult life.

Sightings

I have, up to the time of compiling this book, had four UFO sightings – even though I have never been on a specific “UFO watch” type trip, as some people have. All the sightings I’ve had can be classed as “LITS” (Lights In The Sky) and I have never had any kind of contact, abduction or “missing time” experience.

1974 or 1975 Skipton, North Yorkshire, UK.

It was during school term time, but at about 9pm at night. I was about 10 years old and had been at a Youth Club associated with St Stephen’s Primary School in Skipton. The Youth Club was held at the Convent which is off Castle View Terrace. A group of perhaps 10 children and a few adults had just come out to go home - about 9 or 9:30pm and it was dark. Looking to the South East, into a starry sky, I noticed 2 “stars” were moving roughly in the direction of my gaze. I pointed up and my class mate, Catherine McKenna, looked up and also saw the 2 objects, which were performing a kind of acrobatic manoeuvre round each other, the approximate path of which is shown in the digital sketch mock-up I drew out.



Approximate path of 2 objects seen manoeuvring round each other – sighting lasted about 30 seconds maybe.

The 2 objects went out of sight in about 30 seconds. Catherine acknowledged she had seen the same thing.

Rugby, Warwickshire, 1990



A Mayfly!

In about 1990 – in the summer, I was travelling back home to Nottingham, from a wedding, but had made a stop-off in Rugby, Warwickshire – sometime after midnight. I was in a layby, which I think was just off the A426, heading towards Lutterworth, and looked to my left – over a field. It was a clear, mild night and so I looked

at the stars for a minute or two, just to pass the time. At that moment, I saw a strange object which at first I thought was a large insect, with illuminated body segments. It reminded me, to some extent, of a Mayfly, or even a Dragonfly. I saw it flit across my field of view – I think in a North to South direction – in just a couple of seconds. If you can imagine certain parts of the abdomen and wings being illuminated with neon tubes – orange and yellow and red, that is what it looked like! I have never seen anything like it before or since, nor have I read of any similar descriptions in any witness accounts.

I wondered if, indeed, I had just seen a luminous insect at close quarters, but the UK doesn't have any luminous insects of this nature, so I have no idea what it was.

Borrowash, Derbyshire - 15th July 2005

It was a lovely sunny evening, I decided to go out and have a short walk. There was only a light breeze - of perhaps 5 or 6 miles per hour at ground level. We have a disused canal just next to our house and it's quite a pleasant walk along there.

I was walking East at about 6:35pm and I looked up, at an angle of about 60 deg. into a blue sky. I saw a small white, spherical object slowly drifting south. It looked to be changing in brightness just slightly. I carried on walking, as I thought it was most likely a child's/party helium balloon - the rubber type, not a mylar one. I thought the small change in brightness might due to a pattern on the balloon.

I kept watching the thing for about 30 seconds and as I watched, about 5 or 6 more similar, but slightly smaller and less bright objects came into view, in the vicinity of the bright one. At first, I thought I might simply be witnessing a "balloon release" but then 5 or 6 objects appeared, faintly, in the shape of a V. I stopped and then dashed back to the house, to get the binoculars, so that I could get a closer view to see if they really were balloons. During my Dash, I stopped after about 10 or 20 seconds and looked round to see if I could still see them. No sign, so I dashed again for the binoculars.

After about another 30 or 45 seconds I was back at the house and had got the binoculars out. The part of the sky the objects were visible in is viewable clearly from one of the top bedrooms, so I took the binoculars in there to have a good look. I expected that if they were balloons, they should still at least be visible - especially with the 10 x 42 binoculars I was using. The sky was still as clear as it was only 1 or 2 minutes earlier when I had seen the objects. They had all disappeared.

St Dogmaels near Cardigan Town - 15th July 2009

Oddly, this was 4 years to the day after my previous sighting... I was visiting a friend called Peter. (We had corresponded by email for quite some time.) Peter lives near Cardigan, West Wales and we were staying in a holiday cottage about 8 miles from Cardigan, so I drove over to meet him, arriving at his house at about 7:30pm. We talked for quite a while. Even though it was July, it was rather a cool evening and he put his log/wood burner on.

I was sat in an armchair near his front window and at about 10:30pm, I noticed an odd light, out of the corner of my eye. I leaned to my right, to look out of the window and I saw a bright orange orb and a white orb travelling in parallel, roughly west at a moderate speed. The orbs were about half the apparent size of the full moon. I said to Peter I could see these orbs and that they seemed to be heading over towards the back of the house, so we went up the stairs to look out of a back window, but the view was obscured there. The apparition of the orbs only lasted a few seconds.

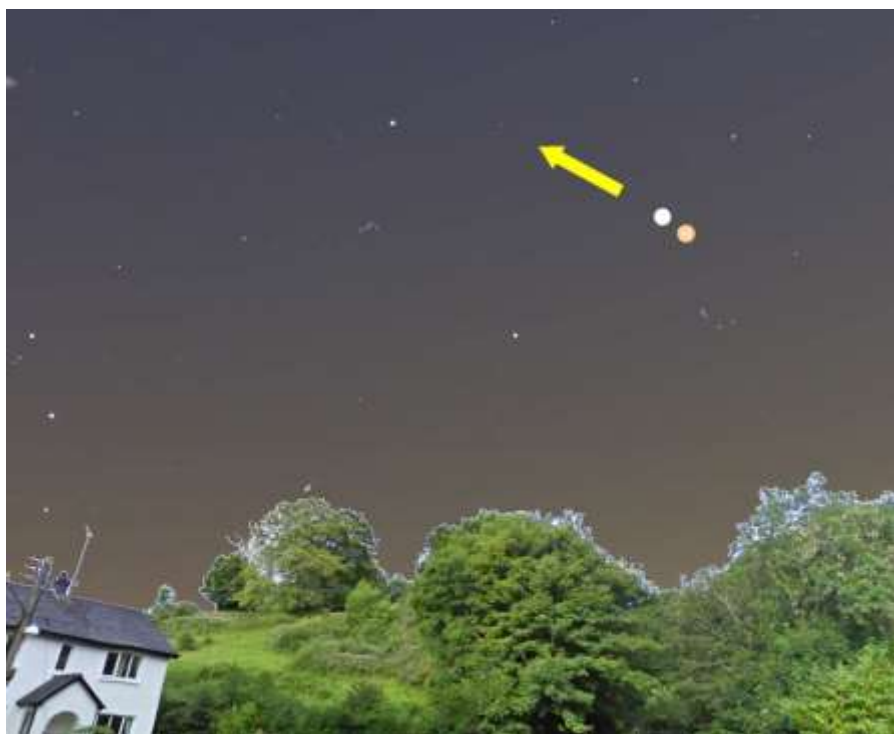

View looking approx. West-South-West about 10:30pm on 15 Jul 2009 in St Dogmaels, West Wales. Orbs travelling roughly west. The lower orb was orange in colour.

So, those are the only sightings I have had – they have been enough to keep my curiosity alive!

How I Got Involved in Research

As I have stated in my other books, it was in 2003, in between my second and third sightings, that I first found out about [The Disclosure Project](#)⁷, following some research I did, after watching a documentary called [Britain's Closest Encounter](#)⁸ (aired in March 2003 on BBC 3). This documentary was about the Rendlesham Forest incident which took place in December 1980, where one or more craft landed in the forest. There were multiple military witnesses, several of whom approached the landed craft and inspected it at close range. By 2003, several books had already been written about the Rendlesham Forest incident, the best one being [Georgina Bruni's "You Can't Tell the People"](#)⁹ (apart from the foreword being by Nick Pope, whom we shall discuss later.)

In early 2003, a fast Internet connection (yes, a whole 128 kbps!) service had just become available in our area. Having watched the programme, I was able to download a large video file. [This video was of a press conference, held in Washington DC in May 2001](#)¹⁰ – which I still consider to be an event of huge importance. It was Dr Steven Greer's Disclosure Project Press Conference, where 21 highly qualified (and, following my own research, I would say, mainly truthful/honest) witnesses. Having studied this, [I joined the Disclosure](#)

[Project Representatives Group](#)¹¹ – which was just a loose association of people who were familiar with the material and the nature of the project. As a representative, it was suggested you try and show the material to others by, for example, organising a showing of one of the DVDs. You could get your event listed on their website. I organised several film showings at different venues and, when I was able to recover my expenses, I donated any small amount back to the Disclosure Project. (Over a two-year period, I probably donated a total of about \$100 - \$200). In the next year, after being listed on the Disclosure Project Website, several people contacted me, and they seemed to share the same interest in the material.

2. UFO/ET Perceptions

Terminology

In this volume I will primarily use the term UFO – by which, in most cases, I *really* mean “craft of extraterrestrial origin.” Of course, the term means “Unidentified Flying Object” and it was first coined by Edward J Ruppelt in 1952. The coining of this term itself includes the idea that the object cannot be properly characterised – when in some cases, shapes, colours and behaviour have been observed, photographed and described. Since about 2017, a new term seems to have been “bandied about” – that of UAP – “Unidentified Aerial Phenomena” – but I will be sticking with the “old” term, for the most part.

“ET” is used here, as in most places, to mean “Extra Terrestrial” meaning “off-planet.” In many cases, I realise, I and others that I quote – will be making implicit assumptions about the origins of the things I discuss and describe here. This is inevitable, in the absence of accurate and truthful information from the “powers that know more about the evidence than we do.” If there wasn’t a cover up, we would not need to make as many assumptions and our descriptions and use of terminology could be more accurate and appropriate.

Discovering a Disclosure Project...

As I have illustrated in my other books, it is clear to me that we cannot rely on the mainstream media to provide good quality, accurate and balanced coverage of topics such as UFOs, 9/11 and so forth. In the main, the quality of most documentaries on these topics has seemingly diminished since the turn of the century/millennium. In some cases, the propaganda contained in these documentaries becomes obvious to anyone who has done a decent amount of research for themselves.

When I discovered the Disclosure Project in 2003, it was a “turning point” for me because, having watched the conference, I *knew* there was a sophisticated cover up in place. Prior to watching this event, I only considered that “there was *probably* a cover up.” I became certain that the cover up was real, and so I was spurred into action.

The Disclosure Project is/was a movement to try and disclose the truth, as told in first-hand witness testimony, about the UFO phenomenon. In 1993, Dr Steven Greer, formerly an ER doctor, started to identify first-hand military and government witnesses to UFO related events and projects. By 2000, he had transcripts of testimonies from over 400 of these witnesses – he had videotaped about 100 of them.



Disclosure Project Press Conference, May 2001

Over the next year, he compiled all this into a “usable” form. A wide range of testimony is now available – about significant sightings, and involvement in covert projects, mainly in the USA. Greer collected many documents (from witnesses and elsewhere), in many cases, to directly support the validity of the testimony. However, I will have a *lot* more to say about Dr Steven Greer

in chapter 23 and elsewhere. Following a review of some of Greer’s material and when I had listened to what the witnesses said, I looked for media coverage of the event. One immediate observation I made was in relation to the woefully inadequate reporting of what these “Disclosure” witnesses had actually said. Following my viewing of the Press Conference, [I read an article on the BBC news website](#)¹² – part of which is reproduced below.

BBC NEWS
 You are in: World: Americas
 Thursday, 10 May, 2001, 04:14 GMT 05:14 UK

UFO spotters slam 'US cover-up'
 By Washington correspondent Rob Watson

Neil Armstrong was not the first being on the moon.

That, at any rate, is the position of the suitably sci-fi sounding Project Disclosure that launched a campaign in Washington on Wednesday.

It is aimed at persuading the US Congress to hold hearings on the existence of unidentified flying objects and extra-terrestrials.

The campaign believes the US Government has known about the existence of UFOs for over 50 years but has been trying to hide it.

'Alien life forms'
 It was surely the strangest ever news conference hosted by Washington's august National Press Club.

Search BBC News Online
 GO

Advanced search options
 Launch console for latest audio/video

- BBC RADIO NEWS
- BBC ONE TV NEWS
- WORLD NEWS SUMMARY
- BBC NEWS 24 BULLETIN
- PROGRAMMES GUIDE

See also:

- 14 Nov 00 | Scotland First contact for UFO mecca?
- 09 Aug 00 | Sci/Tech Magnetic 'solution' to crop circle puzzle
- 04 May 00 | Africa South African 'UFO' was US rocket
- 19 Apr 00 | Americas New search for aliens
- 18 Apr 00 | Americas Secret 'UFO base' revealed
- 20 Jan 00 | Scotland UFO theory 'does not wash' with experts
- 04 Jul 98 | Sci/Tech We are not being visited

Internet links:

- International UFO research centre
- Search for Extraterrestrial Intelligence

The BBC is not responsible for the content of external internet sites

Top Americas stories now:

Front Page World
 Africa
 Americas
 Asia-Pacific
 Europe
 Middle East
 South Asia

From Our Own Correspondent

Letter From America
 UK
 UK Politics
 Business
 Sci/Tech
 Health
 Education
 Entertainment
 Talking Point
 In Depth
 AudioVideo

The BBC's Rob Watson in Washington
 "20 witnesses: All ex-military and all deadly serious"
 real 28k

BBC Website News Report from 2001.

Those reading the headline would come to realise that witnesses such as Captain Robert Salas (a former nuclear missile launch control officer) and John Callahan, former Division Chief of the Accidents and Investigations Branch of the FAA in Washington DC were just “UFO spotters.” As usual, the reporting was hopelessly inaccurate and contained an undertone of ridicule or faint mockery.

I had discovered the Disclosure Project almost 2 years after it happened. It was a highly significant event. Hence, there *was* a media cover up.

Another of the things I found quite powerful in studying the Disclosure Project material was the corroborating testimony it contains. Different witnesses reported the same thing – from different situations. (As an example, there are several cases described where visual and radar contact of UFOs was established – and official records of these cases existed – [such as the Japan Airlines Case from 1986](#)¹³). The same sorts of events and observations seemed to have been made across four decades. If you have not studied this before, I do recommend you invest time in working your way through [Dr Steven Greer’s “Executive Briefing” document](#)¹⁴, which is available online. [Similarly, his 2-hour or 4-hour Disclosure Witness video makes for compelling viewing.](#)¹⁵

As I mentioned earlier, I downloaded the 2001 Press Conference video and bought one of the DVD’s. I organised a small public event to show some portions of these videos. Later, I wrote to local clubs (women’s groups, Probus groups and others) and offered my “services” as a speaker to talk about the Disclosure Project (and at the talks I gave, I usually mentioned the energy issue when there was time). I invested not a small amount of my own money in equipment to do the presentations (LCD projector, portable speakers etc).

In 2005, I was even contacted by a man called Brian Coleman in London, who wanted to do a Disclosure Project presentation. He later booked a small room in the Friends’ Meeting House on Euston Road, and he advertised a Disclosure-related event. He invited local reporters and spoke briefly about it on local radio. I took the equipment, which allowed us to show the video. The first event was attended by about 20 people.

Dishonest Media Coverage

It is stating the obvious, I know, but many people in Western Culture get their ideas about the everyday events through the Television and Newspapers. Though many would reject the idea that our media is “controlled”, few would dispute that it *is* often *influenced*. For example, many papers print stories which they know will “sell copies”. Particularly in recent years, many pages of print are filled with celebrity news for instance. This is, to my way of thinking, a kind of censorship in itself – i.e. the printing of stories which will “sell copies” is a censorship of stories which won’t “sell copies”.

In TV, programmes are produced to fit a “brief” – with subjects like UFOs and the paranormal, the conclusion of the programme and what it will show is stated *before* the programme has been made, so the content is recorded and edited to fit the conclusion. It is now never the case that the conclusion in a TV documentary programme is arrived at based on the evidence that is available to the producers.

Since approximately 2005, Web and Internet usage has become much more advanced and perhaps as many people read news stories online and via Social Media as on TV and in the printed newspapers. Some news is therefore presented in a manner that can be described as “click bait.” In simple terms, those who wish to control what people think have seemingly just arranged that more “noise” is generated, to cloud the truth of any important issue. This “noise generation” then forms part of a larger “Perception Management” strategy which we will touch on later in this book, at various points.

Here, I will give just one example, from my own “files,” of the abject dishonesty in media coverage of an important UFO related event. (Again, I have covered some similar examples of media dishonesty in my other books.)

“UFOoled”

Here in the UK, in July 2003, *The Daily Mail* published an article about the [afore-mentioned Rendlesham Forest UFO case](#)¹⁶. Why was it necessary to print this old story in the Daily Mail, almost 23 years after the event took place, when most people had probably forgotten about it? Was the story printed because of the airing of the “[Britain’s Closest Encounter](#)¹⁷” documentary mentioned earlier? Was this part of a coordinated Perception Management operation? (You can probably find many similar examples in the media reports in your own country - particularly if you live in North-Western Europe or the USA or Canada.)

By Michael Hanlon

UFO-OLED!

For 23 years Britain's 'Roswell incident' has been cited as proof that UFOs landed. Today, a retired U.S. airman claims, he was behind the hoax ... using a battered old police car and sticky tape



THINGS were said in 1947 that led to the belief that little green men from outer space visited the Earth and a military base near Roswell. It is nearly 60 years since the claims of those who say the all these reports of flying saucers, saucer-shaped discs, disc-shaped flying saucers into the sky. Thousands of other witnesses report sightings of alien aircraft over the years. Some of these sightings have been investigated by the military and the police. Some of these sightings have been investigated by the military and the police.

WHAT they said, it has been said since the first time that the British had a UFO sighting. It was in 1947, when a British pilot reported seeing a saucer-shaped object in the sky. The object was described as being similar to a saucer and was seen by the pilot and his crew. The object was described as being similar to a saucer and was seen by the pilot and his crew.



Confession: Kevin Condo

... that it was a day or two before the incident to play a practical joke. ... had no idea what I had meant by doing this. ... the British pilot said that he had seen a saucer-shaped object in the sky. ... the British pilot said that he had seen a saucer-shaped object in the sky.

One of the reasons why the British had a UFO sighting in 1947 was because of a hoax. ... the British pilot said that he had seen a saucer-shaped object in the sky. ... the British pilot said that he had seen a saucer-shaped object in the sky.

UK Daily Mail "Rendlesham Hoax" article from July 2003

I knew from Disclosure Project Materials that (UK) Admiral Lord Hill Norton had interviewed many of the Rendlesham witnesses himself. He is quoted in the Disclosure Project Materials based on an interview he gave to James Fox, producer of the "Out of the Blue" Documentary (2003¹⁸):



What he (Halt) said is what I have just described. That is one explanation — that it actually happened as Colonel Halt reported.

The other explanation is that it didn't. In that case, one is bound to assume that Colonel Halt and all his men were hallucinating. My position is perfectly clear

— either of those explanations is of the utmost defence interest. It has been reported and claimed — and I, myself, have raised it to ministers at the Defence Ministry in this country — that nothing they have been informed about regarding UFOs is of defence interest. Surely, to any sensible person, either of those explanations cannot fail to be of defence interest. That the Colonel of an American Air Force Base in Suffolk and his military men are hallucinating when there are nuclear-armed aircraft on the base — this must be of defence interest.

And, if indeed what he says took place, did take place — and why on Earth should he make it up — then, surely, the entry of a vehicle from outer space (and certainly not manmade) to a defence base in this country also cannot fail to be of defence interest. It simply isn't any good for our ministers — and the Ministry of Defence in particular — to say that nothing took place that December night in Suffolk, or that it is not of defence interest. It simply isn't true.

Lord Hill Norton died in 2004 and, to my knowledge, none of the words above were ever quoted in any mainstream newspaper or main news TV or radio program. Peter Hill Norton was *not* quoted in the Daily Mail article above. With this type of thing in mind, I contacted the reporter, Michael Hanlon and he remarked:

I take the view that the people claiming an alien spaceship has landed have all the proving to do, not the people who believed that no such thing happened ...

In this case, [Colonel Halt's now very famous memo](#)¹⁹ (which was never meant to become public) outlines ample evidence that something did land (depressions, somewhat abnormal radiation etc). However, the *Daily Mail* report stated:

'There was a large helicopter which landed there the previous night - a helicopter with three landing skids.'

This is stated in the article as being the explanation of the object which landed, despite the witness testimony that this was not the case. I therefore asked the reporter further about the 'helicopter' explanation. I asked:

Was it an Army, RAF or Coast Guard Helicopter? How often do helicopters land in the middle of the forest, in trees, without being damaged? Who was the pilot? Has he been contacted to testify/verify that he landed there?

The reporter's response was that he had "no idea". He had therefore not felt this part of the explanation worth verifying, even though the alternative ("spaceship" – his word, not mine) explanation would appear to be of great significance. The Daily Mail report did not attempt to cross-check any of Kevin Conde's (the alleged UFO hoaxer named in the Daily Mail report) story with the other available evidence from the witnesses – which had been available for over 15 years by the time the report was published. This therefore leads us onto a discussion of...

Perception Management

Since about 1947, due to a deliberate policy of ridicule and misinformation, people who have UFO experiences often do not openly discuss them, for fear of being thought of as "strange". Whilst many UFOs can be explained as "natural phenomena" (and the list of explanations is quite long – I am not going to go over ground that has already been covered 100,000 times or more), it is sometimes the case that a "natural explanation" is applied where it clearly does not simultaneously cover *all* the features of the witness testimony, but when such explanations are offered, non-experiencers tend to accept them because it allows them to "keep their existing picture of reality".

In my other books, I have tried to illustrate how a strategy of perception management is in operation with regard to what can be called “Alternative Knowledge” topics. The strategy is successful – because I have to use terms like “Alternative Knowledge” – when for many people, it isn’t “alternative” at all. Just today, I clicked on a website where there were some photographs of stalls at a recent UFO conference. A table on one of the stalls was selling T-shirts or posters with the phrase, prominently seen in the X-files TV series on a flying saucer poster in Mulder’s office saying, “*I want to believe.*” Just think about that for a moment. People are already free to believe what they want – you don’t have to have any evidence for beliefs – you can have any belief you desire, at any time. You don’t have to read or study anything in particular to *have a belief*. That’s the good thing about beliefs! The way that language has been used in this context is to *manage perception*. What the phrase should really say, in this context, is “**I want to know the truth about...**” Those who do not understand the difference between *belief* and *knowledge* or would hang a poster or wear a T-shirt with the “I want to believe” phrase on it - have had their perception managed. They have had their understanding reduced and their knowledge diminished. We will see a fair number of similar “perception management” examples later in this work.

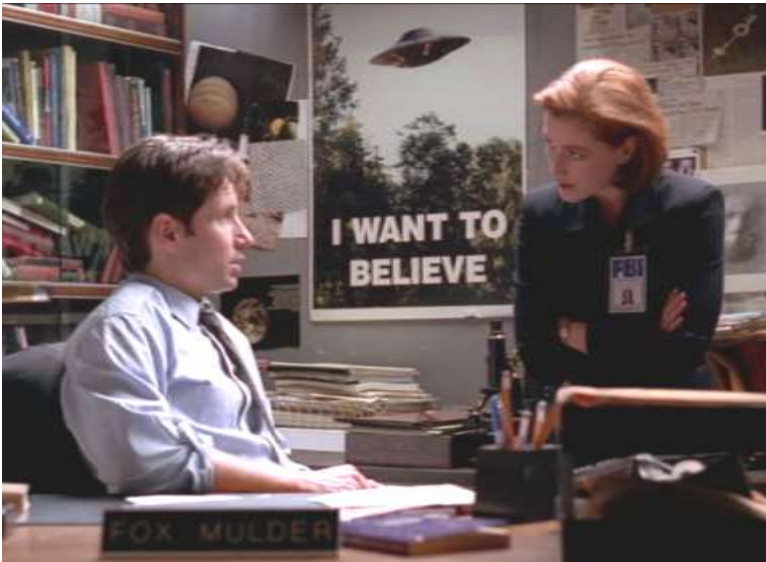

Perception Management - Still from the X Files

The X-files itself can also be classed as a tool of Perception Management, delivering some truthful information in a fictional setting. This was particularly evident in the [first episode of a 2016 “reboot” of the series, which included a character who was strongly reminiscent of Alex Jones of Infowars infamy](#)²⁰. An analysis of this episode alone would take quite a while, as it featured portions of very tightly written dialogue.

The vast majority of people who have not had UFO-related experiences (or similar experiences, not taken seriously in wider western culture) have had

their perceptions managed to a greater or lesser extent. If they don't care about or are not interested in the knowledge, technologies and truths that have been kept from them, which would transform their lives when laid bare, they have had their perceptions managed. It is true that even some witnesses and experiencers have had their perceptions managed too. That is to say, they sometimes don't realise the full implications of their experience, nor the full reasons for why they are often vilified or even ostracised for discussing it. Who can blame them, though, when these experiences are frightening or, forgive me, so *alien* in their everyday lives?

Agnostics, Believers, Sceptics and Knowers

In some cultures, the concepts regarding the reality of advanced flying craft form part of certain teachings or lore – for example, the Vedic scriptures of the Hindu religion. Similarly, some cultures do have a heritage which assumes that off-world non-human intelligences have interacted with humans (we will mention a fairly well-known example of this in chapter 17.)

Most people's immediate reaction is to be fairly sceptical about any claims of UFO/ET related phenomena. Scepticism is necessary – but not just in relation to UFO/ET related reports – all mainstream stories of any significance need to be inspected through a lens of scepticism. This is, of course, because all too often, there is an agenda behind what is being reported and the way it is being reported.

Let us now consider some “categories of people” in relation to how they react to discussion of the UFO/ET topic. We can consider someone who:

1. Has no real interest, no real knowledge.
2. Has some interest some knowledge but considers the subject largely irrelevant.
3. Has interest and knowledge but considers UFOs to be “all in the experiencer's mind”, with no evidence of their “objective reality” (i.e. as real physical objects). Therefore, the subject is only a curiosity, a mystery if you will, about which we are unlikely to find any real answers (i.e. fairly sceptical).
4. Has interest and knowledge considers themselves open minded – there might be “something in it” (less sceptical).
5. “Believer” – believes there is evidence that UFOs are real physical objects and perhaps one explanation is that they are intelligently controlled and possibly Extra-Terrestrial Craft.
6. “Experiencer” has seen or had a UFO-related experience and *knows* of their physical reality, in one way or another.

Within each of these categories, there are a number of subdivisions which people might place themselves in. (In this book, I will mainly be considering the “real physical craft” aspect of the UFO phenomenon, whilst not completely ignoring the “non-physical” aspects.)

The subjects we concern ourselves with here (and those I have written about in my other books) cannot be studied at a University, nor are they regularly

delivered as a subject worthy of academic study in any western educational framework. This, of course, is another facet of the Perception Management of this subject.

For the hardened sceptic, I include a quote from someone called Wilbert Smith, a Senior Canadian Government Communications Engineer (discussed at length in chapter 7), from a speech he made in 1958, regarding this whole subject:

It is not reasonable to assume that hundreds of ordinary, normal people, whose word we would readily accept under more mundane circumstances - for instance, as witnesses to an automobile accident - should suddenly become liars, fools, neurotics, and otherwise quite incompetent observers.

Smith's statement is particularly true in the case of some of the Disclosure Project Witnesses who have, for instance, been in charge of Nuclear Weapons.

Obscuring Truths

Following on from the discussion of perception management, once one realises that UFO/ET experiences and evidence are actually of vast importance, the reason for having a cover up becomes much more obvious. Also, the motivation for having strategies to obscure the truth becomes easier to understand. As I have written elsewhere, if you actually get past the first obstacle that the secret keepers have put in place – i.e. creating the situation where it seems like the issue is not even worth investigating, then the next obstacle is to ensure the curious-minded person encounters false information in a way which makes it difficult to distinguish from the truth. It works in the same (or a very similar) way with the UFO/ET issue as it does with the issues relating to the truth about free energy, cancer cures, 9/11, human evolution and so forth.

Presidents, a Rockefeller and UFOs

While we're on the subject of Governments and UFOs, let us just consider what has been said by several US Presidents when they have been asked publicly about the subject. If you're particularly interested in this area of study, I can strongly recommend Grant Cameron's (old) Website - http://www.presidentialufo.com/old_site/ (It seems he revamped the site in 2010, but then this site was replaced with something called "Beyond Presidential UFO" - whatever that means - in Aug 2018. Thankfully, the important information on the old site can still be accessed.)

Cameron's research seems to indicate that the US Presidents were briefed on the UFO subject, as were some members of their administration. It also appears that [George HW Bush, as a former director of the CIA, "knew a fair amount."](#)²¹ Below, I will just list a number of interesting statements that have come out of the mouths of former US Presidents.

Harry S. Truman

In 1950 (exact date unknown), [Harry S Truman made the following statement](#):²²

“We discussed it ...at every conference that we had in the military, and they never were able to make me a concrete report about it... I haven’t gotten anything on it... there’s always things like that going on, flying saucers and other things, you know.”

Is it just a coincidence that the National Security Council was set up by Truman not long after the Roswell Incident? (Of course, it is – remember, there was a developing threat of communist infiltration, right?)

Jimmy Carter

On 2 November 2007, in an interview with CNN’s John Roberts, Jimmy Carter²³ also made several remarks about his own 1969 sighting of an object (which was officially reported by Carter in 1973)²⁴

Back when I was as a peanut farmer in southwest Georgia, I and about 25 others saw something in the air that changed colors and was round and came and left. We couldn’t figure out what it was It was unidentified as far as we were concerned, but I think it’s impossible in my opinion, some people disagree, to have space people from other planets or other stars to come to us - I don’t think that’s possible.

Ronald Reagan

Ronald Reagan brought up the subject of ET’s several times in his speeches. Toward the end of his speech to the 42nd UN General Assembly on 21 September 1987, Reagan said:²⁵

“In our obsession with antagonisms of the moment, we often forget how much unites all the members of humanity. Perhaps we need some outside, universal threat to make us recognize this common bond. I occasionally think how quickly our differences worldwide would vanish if we were facing an alien threat from outside of this world. And yet I ask - is not an alien force already among us? “

Further research confirms an additional statement that Reagan made – that he had discussed this issue with former Soviet Leader Mikhail Gorbachev.

Another statement from Reagan came when he was shown the “E.T.” film by its director Steven Spielberg. In an [interview by Quint on 06 Jun 2011](#)²⁶, Spielberg told the story²⁷:

Quint: The story I heard is that when Reagan saw it, he started talking about how close to reality it was and he was quickly ushered out of the room. Is that true?

Steven Spielberg: No, he wasn’t ushered out of the room. He was the President of the United States! Nobody could usher Ronald Reagan out of the room!

It was in the White House screening room and Reagan got up to thank me for bringing the film to show the President, the First Lady and all of their guests, which included Sandra Day O’Connor in her first week of as a

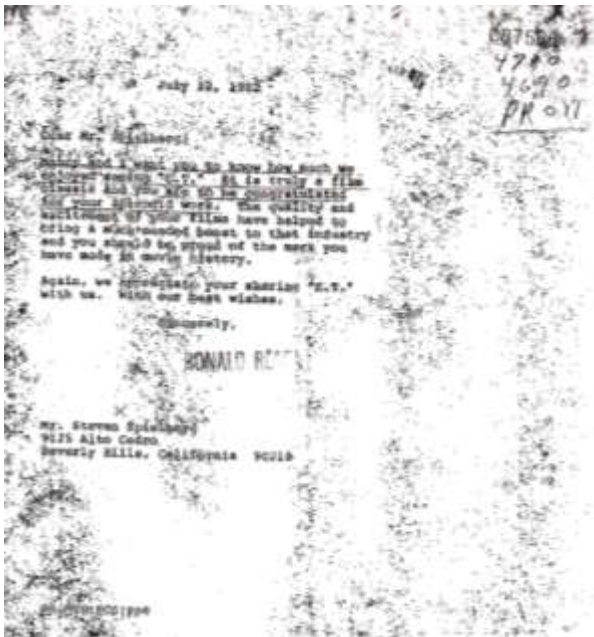

Justice of the Supreme Court, and it included some astronauts... I think Neil Armstrong was there, I'm not 100% certain, but it was an amazing, amazing evening. He just stood up and he looked around the room, almost like he was doing a headcount, and he said, "I wanted to thank you for bringing E.T. to the White House. We really enjoyed your movie," and then he looked around the room and said, "And there are a number of people in this room who know that everything on that screen is absolutely true."

And he said it without smiling! But he said that and everybody laughed, by the way. The whole room laughed because he presented it like a joke, but he wasn't smiling as he said it.

Bill Clinton

[A peculiar remark in a speech that the thoroughly corrupt Bill \("tainted blood"\) Clinton made in Belfast, Northern Ireland on 30 Nov 1994 is included below:](#)²⁸

I got a letter from 13-year-old Ryan from Belfast. Now, Ryan, if you're out in the crowd tonight, here's the answer to your question. No, as far as I know, an alien spacecraft did not crash in Roswell, New Mexico, in 1947. And, Ryan, if the United States Air Force did recover alien bodies, they didn't tell me about it, either, and I want to know.

Both the Clintons met with Laurence Rockefeller at least twice in 1995 and in at least one meeting, the subject of ET/UFOs was discussed. [There is much more to this story!](#)²⁹

On 02 April 2014, Jimmy Kimmel interviewed Bill Clinton and said:

Kimmel: If I became president, I would run to the White House and I'd demand to see all the classified files on the UFOs because ... I'd want to know what has been going on. Did you do that?

Clinton: Sort of ... at the beginning of my second term we had the anniversary of Roswell ... there's also area 51 you remember there was a great sci-fi movie where there was an alien kept deep under the ground...area 51... so first I had people go look at the records on area 51 - to make sure there was no alien down there - and people thought that because everybody who works there has to stop, about an hour away, and put on special clothing and then drive in and out. And that's because a lot of our stealth technology is made there. We know that now - but there are no aliens there. So... when the Roswell thing came up, I knew we'd get, you know, zillions of letters, so I had all the Roswell papers reviewed - everything.

Kimmel: If you saw that there were aliens there would you tell us?

Clinton: Yeah ...We know... we live in an ever-expanding universe. We know that there are billions of stars and planets - literally - out there and the universe is getting bigger. We know from our fancy telescopes that just in the last two years, more than 20 planets have been identified outside our solar system that seemed to be far enough away from their Suns - and dense enough that they might be able to support some form of life. So it makes it increasingly less likely that we're alone.

Kimmel: Oh, you're trying to give me a hint that there are aliens?

*Clinton: I'm trying to tell you I don't know, but if we were visited someday, I wouldn't be surprised... I just hope that it's not like "Independence Day" - it's a, you know, a conflict. **Well, now we have maybe another way to unite us...***

Kimmel's initial question may have been prompted by statements in Webster Hubble's "Friends in High Places" book about Clinton's request to Hubble to find out what was known inside the government about the UFO issue.³⁰

Kimmel later asked the same question of two other guests...

Barack Obama

On 12 March 2015, Jimmy Kimmel hosted Barack Obama (Barry Sotero – How does an acting President have time to spend on a light-hearted chat show?) Kimmel again states he will “run to the White House” to find out about UFOs and then asks Sotero (Obama):

Kimmel: Did you do that?

BO: That's why you will not be president.... (Laughter) The aliens won't let it happen... You'll reveal all their secrets...(Laughter) They exercise strict control over us...

Kimmel: ... So did you look did you see did you exploit...

BO: I can't reveal anything...

Kimmel: Oh really? Because President Clinton said he did go right in - and he did check - and there was nothing

BO: Well, you know ... that's what we're instructed to say. (Laughter)

Hillary Clinton

On 24 March 2016, Kimmel interviewed Hilary Clinton. He again states he'd go looking for UFO information:

Kimmel [Referring to Bill Clinton] ...he did do that yes and then he didn't find anything....

H Clinton: I'm gonna do it again. Yeah. And you know there's a new name - It's unexplained aerial phenomenon... UAP that's the latest nomenclature.

Kimmel: I like the old one. I like UFO. I don't know why.

H Clinton: Well I think we can use them interchangeably, but I would like us to go into those files, and hopefully make as much of that public as possible. If there's nothing there, let's tell people there's nothing there.

Kimmel: What if there is something there?

*H Clinton: Well, if there is something there unless, it's a, **you know, threat to national security**, I think we ought to share it with the public*

Kimmel: Well what if everybody's all hopped up on medical marijuana and everybody gets paranoid.

H Clinton: That's why I want more research...

Kimmel: If you share it with me, I'll decide what is the best course of action. I really have my ear to the ground.

H Clinton: Well you, know I'm more than happy to do that.

We will likely revisit this theme later, but it is fairly clear to the keen observer, we will never get disclosure from corrupt politicians – there are far, far too many ramifications.

In the text I have emboldened, you might be able spot additional elements of perception management – but not directly related to the UFO issue.

Governments Release Documents (2008-13)

In May 2008, the [UK Government started to release documents related to the UFO phenomenon](#).³¹ On the National Archives Website, you can see that there are over 200 files which were released between 2008 and 2013. These document releases received some media attention (and I was asked onto local radio to talk about some aspect of the release, but didn't even bother to study the documents that much, because I felt pretty certain it was just more "limited hangouts" and no one would be confirming what, for example, Disclosure Project witnesses, and others, had stated years previously. I was sure that nothing would be blazing across the media admitting to a decades-long cover up of knowledge about crashed craft and black programmes. I was right!).

Similarly, in 2010, the [New Zealand Defence Force released UFO documents \(after anonymising them\)](#).³² Of course, the very fact of anonymising them means any value they may have had was reduced.

Some people seemed to give these releases quite a big fanfare and suggested that formal disclosure was really happening. However, my conclusion was that we were just seeing *a few* documents, formerly kept secret by governments and military forces, which held exactly the same sort of UFO accounts as we'd seen in the public record for decades. The only difference was that, perhaps, the witness involved was working in their government role at the time the sighting was reported.

[A page on Steven Greer's "Sirius Disclosure" website](#)³³ provides a list of approximately 13 countries' governments or establishments releasing formerly secret documents, between 2005 and 2012 – with the most document releases occurring between 2007 and 2009. Was it just a fad? Or, was it just a reflection of the burgeoning "Broadband Internet Age," where the established controlling interests were, once again, rolling out just another phase of their global perception management plan?

Formal Investigations

USA

Some people who know about the reality of aspects of the UFO/ET phenomenon (landings, bodies and so forth) have supported efforts for formal investigations to be done. Here again, however, we have to consider carefully that several "formal investigations" have *already* been done by several different governments around the world. Students of the UFO subject will be aware of [Project Sign](#), [Project Grudge](#) and [Project Blue Book](#) and the later [Condon Report](#).³⁴ Less well known from the twentieth century is [Project Saucer](#), which was initiated by the US DoD in January 1948 and a report was published via [Wright Patterson AFB](#) (then [Wright Field](#)) the following year.³⁵ In addition, two sets of [Congressional Hearings](#) took place in the USA in 1966 and 1968³⁶.

But what was the result of these efforts? Did they change the way the media and academia operate in relation to evaluating evidence related to the UFO/ET phenomenon? Apparently not. Over the last few decades, there have been several advocacy groups that have sprung up (and faded away) that have echoed the words of the late [Lord Peter Hill Norton](#), mentioned earlier³⁷:

"This should be the subject of rigorous scientific investigation, and not the subject of rubbishing by tabloid newspapers."

Perhaps he didn't realise that mechanisms of perception management and the control of certain information are just as effectively applied in academia as they are in just about any organisation you can think of.

France - COMETA Report

In 1999, the French Government published its own "COMETA" report. The title of this document was "[UFOs and Defense: What must we be prepared for?](#)"³⁸ This important 90-page document was not officially translated into English and is, to this day, rarely discussed.



COMETA Report

(Perhaps the “non-translation” is a good excuse for the fact that if you go to the BBC News Website end enter “COMETA” as a search keyword, you will find nothing³⁹.) A summary of the report, by Gildas Bourdais explains⁴⁰:

The study was carried out over several years by an independent group of former “auditors” at the Institute of Advanced Studies for National Defense, or IHEDN, and by qualified experts from various fields.

Before its public release, it was sent to French President Jacques Chirac and to Prime Minister Lionel Jospin.

The report is split into 5 main sections including an introduction and conclusion. Section 1, entitled “Facts and Testimonies,” covers testimonies of French pilots, Aeronautical Cases and other sightings and encounters, and explainable phenomena. Section 2, entitled “The Extent of Our Knowledge” looks at UFO research in France and around the world. Section 3, entitled “UFOs And Defence” includes a discussion of Strategic Planning, Aeronautical Implications, Scientific and Technical Implications, Political and Religious Implications and Media Implications. A conclusion and recommendations section then follows, along with a bibliography and glossary.

The conclusion states:

The UFO problem cannot be eliminated by mere caustic and offhand witticisms...

[studies that have been done] demonstrate the almost certain physical reality of completely unknown flying objects with remarkable flight performances and noiselessness, apparently operated by intelligent [beings]...

Secret craft definitely of earthly origin (drones, stealth aircraft, etc.) can only explain a minority of cases. If we go back far enough in time, we clearly perceive the limits of this explanation...

A single hypothesis sufficiently takes into account the facts and, for the most part, only calls for present-day science. It is the hypothesis of extraterrestrial visitors...

A model of magnetohydrodynamic technology, which could be employed to propel the UFOs in the atmosphere, has been well developed... The extraterrestrial hypothesis is far from the best scientific hypothesis. It certainly has not been categorically proven, but strong presumptions exist in its favor and if it is correct, it is loaded with consequences.

This leads to the question of “what should be done?” when reports such as this publish findings strongly implying the reality of one or more physical phenomena, that either involve non-human intelligence or highly advanced technologies? It becomes more and more obvious that black world knowledge of these things has not been properly explained or disclosed to those of us in the white world.

In 2000, Journalist Leslie Kean had tremendous difficulty in getting her story about the COMETA Report published⁴¹. It was finally accepted by the Boston Globe (in the USA). Kean has continued to write about the UFO/ET issue but, like so many other researchers, doesn't really "connect enough of the dots" and see that people around her in the "field of UFOlogy" are also part of the cover up.

One aspect of this, which I have already written up extensively in three of my other books, is the truth about what happened on 9/11. Leslie Kean, like Steven Greer, Steve Bassett, Nick Pope and many others have not yet publicly stated that the cover up about the UFO/ET issue is unquestionably related, in some way, to the cover up of what happened on 9/11. This is perhaps *the acknowledgement* that is needed if we wish to learn more about the truth regarding UFOs, aliens and the like.

I would like to think that this book will help, eventually to lead to this very acknowledgement, so that the power of the groups running the planet is diminished and their strategies of cover up, perception management - and just outright lying - are less effective.

Conclusions

From my own observations regarding the coverage of the UFO/ET issue in the mainstream media, little real progress has been made since the 1960s. Stories are rarely studied in depth and the most important evidence is rarely discussed in an appropriate way. During the 1990s, there seemed to be some more comprehensive and somewhat reasonable documentaries made (in the UK there were at least three I can think of immediately – "Strange but True," "Riddle of the Skies," "Billion Dollar Secret.") Since then, the style of documentary-making has changed – often with over-dramatization, many "flash-edits," more sound-bites and repeated statements around the breaks for advertisements. The explanations and coverage are generally much more superficial, though the production design and visual quality, graphics and so forth are much improved.

In chapter 31 of "Finding the Secret Space Programme,"⁴² I go into more detail regarding precisely how the media manages the perception of so-called fringe topics in documentaries. The objective, of course is to... *keep them* in the fringe...

At the risk of seeming to be frivolous, we will next look at the way in which the topics of UFOs and Aliens have come up in Hollywood films and some popular music. However, the way this is done is, I suggest, another strand of Perception Management operations.

3. UFO/ETs in Songs and Cinema

Before we delve more deeply into the evidence which I think proves that not only do physical extraterrestrials exist (and they have visited our planet on many occasions), I would like to have a brief look at how the subject of UFOs/ETs is presented in some popular music and in a few Hollywood films/movies. I wanted to do this because many people first encounter the concepts of UFOs/ETs either in films/movies or in some pieces of popular music.

Readers who want to explore the “UFOs in popular music” area in more depth can look at [Alien Rock](#)⁴³ by [Michael Luckman](#)⁴⁴, which discusses the “ET Experiences” related by many well-known pop and rock artists such as Elvis and Jimi Hendrix. Those interested in aspects of the portrayal of aliens and ET’s in films can read “[Silver Screen Saucers](#)” by [Robbie Graham](#).⁴⁵ [Robbie Graham also has a number of interesting articles posted on his website.](#)⁴⁶

“Believing the Strangest Things, Loving the Alien...”

If you are familiar with popular music, when you sit down and think about it, there are actually quite a few songs that mention aliens or spacecraft and I am not going to list them all here!

As many readers will guess, I stole the title of this section from the [lyrics of David Bowie’s modest 1985 hit “Loving the Alien”](#)⁴⁷. So let me start there...

David Bowie – “Alien Entity”?

I find certain lines in “Loving the Alien” to have particular resonance and the whole song has a certain “feel” to it which I find both uplifting and disconcerting at the same time. Perhaps this is partly because, for me, it has a certain nostalgia attached to it, as it was released in the middle of the time I was at University. The song is meant to relate to organised religion, but the use of the word “alien” seems rather odd to me. [The video for the song](#)⁴⁸ is rather surreal, with some images which appear to be almost “random” and bizarre. Perhaps the video shows Bowie in his most enigmatic form. As well as this song, we can remember several of his other songs in which he mentions the themes of space, extraterrestrials and so on. Indeed, his first commercial success was released in 1969, entitled “[Space Oddity](#)⁴⁹” - presumably the title was an altered version of that of the Stanley Kubrick film “2001: A Space Odyssey”, based on Arthur C Clarke’s novel. ([And there’s quite a story behind that film too!](#))⁵⁰

I feel that [David Bowie](#)⁵¹ (real name David Jones), UK icon and “avant garde” actor, songwriter, singer and artist, had contact with some other form of “alien” or higher consciousness. In the light of what I know now about the reality of extra-terrestrials and their appearance in our skies (and on the

ground), reviewing the lyrics in some of Bowie's songs, I have to wonder if Bowie was trying to express his own contacts in his music.

In "Starman"⁵², Bowie sings:

There's a starman waiting in the sky, he'd like to come and meet us, but he thinks he'll blow our mind.

Though the title of his 1973 hit "Life on Mars"⁵³ is seemingly a metaphor for something else, it is an interesting title, nevertheless. Perhaps the most interesting lyrics of all⁵⁴ are contained in "Oh You Pretty Things"⁵⁵. Here he sings: "Homo sapiens have outgrown their use" and "You gotta make way for the Homo Superior" (some people know this song because it was a hit for Peter Noone, formerly of Herman's Hermits). Which other songs (of any genre) talk about "homo superior"?

David Bowie is the main subject of a fascinating timeline⁵⁶ - about his life and various "UFO" events, presented in a set of webpages in about 2009, now only available in the Internet Archive (with some photos missing, unfortunately). It includes a mention of the very unusual film *The Man Who Fell to Earth* (1976) in which Bowie starred as an "alien castaway".⁵⁷

I tentatively suggest that Bowie had some kind of communications with "intelligent non-human consciousness." One can also review Bowie's final work "Blackstar" - particularly the music video for the title track, which is full of dark symbolism⁵⁸. When one studies this idea more generally, it seems that other people have too - there are some things which they write about which seem to go beyond just imagination or fantasy. We will see some relevant examples below.

"No Doubt About It"

Another popular song telling the tale of a brief UFO encounter is "No Doubt About It" by 1970s/1980s UK pop group Hot Chocolate⁵⁹. The song was released in May 1980 and reached number 2 in the UK chart. This is one of my personal favourites, due to the lyrics⁶⁰ and their passionate delivery by Errol Brown. It is worth considering these lyrics carefully:

*If someone tells you there's no other form of life,
And you believe in them too
I'm gonna tell you 'bout the other night,
I swear that it's true
A cloud of white, and green, and flying ships,
I've never seen
Came into my view*

*Was I frightened? Was I scared? Was I thrown into confusion?
As they glided down so silently, it wasn't an illusion
No no
No doubt about it
Oh no
No doubt about it*

*What kind of magnetism kept me in this place?
Was it out of my control?
What was the ship from outer space?*

*What was this creature that appeared before my eyes?
Was it good? Was it evil?
On the ship from other skies
I was frightened. I was Scared. I was thrown into confusion.
As they stood right there in front of me...*

I remember hearing, as long ago as the 1980s or 1990s, that this song was inspired by an event that one or more of the band members witnessed. This seems to be confirmed [in a 2011 article in the Watford Observer](#)⁶¹. Steve Glen, who co-wrote the song with Mike Burns, is quoted in the article:

It's a true story," insists Steve. "I was driving on the Hendon Way with my writing partner Mike Burns and he pointed up to the sky and said, 'what's that up there?' I nearly drove off the road. I was producing The Toys at the time and the band was following behind us in a van. I veered off onto West Heath Road and stopped by the Leg of Mutton Pond. It was right above us. It was massive – about four or five houses wide and when we got out to have a look, an orange cloud came out of it."

When I ask Steve if anyone might have slipped something in his dinner that night, he's adamant it really happened.

"The reason I've not talked about it much for 30 years is everyone said at the time we must be on drugs but all six of us saw it. We asked each other 'did you see that?' and we all said, 'yes'. We went straight back to Mike's house in Long Elms and wrote the song No Doubt About It. I'd never written one so quick, and it was Hot Chocolate's biggest seller."

It is not clear how much of the song is "true." There is no account of the ship actually landing and beings getting out. The music video is suggestive that beings were seen, but of course, that could all have been added for the "entertainment value."

John Lennon – Not Imagining

[It is not all that well known that John Lennon had a UFO sighting in New York](#)⁶². He refers to the experience on the cover of his album "Walls and Bridges", which was released in 1974, saying that he saw a UFO on August 23. Perhaps the sighting also inspired a line in his song "Nobody Told Me... (Strange Days Indeed)" where he sang "There's UFOs over New York, and I ain't too surprised..." [Lennon was with his girlfriend or ex-girlfriend or personal secretary, May Pang](#)⁶³ when the sighting took place – and she has confirmed the details. Lennon drew a sketch of the sighting too. [He also gave an account of the sighting in a recorded telephone interview \(date unknown\)](#)⁶⁴.

I'd just finished doing "Walls and Bridges" ... done the last tape of it... and I was really relaxed and I was feeling good and it was summer in New York and I had the window open and lo and behold, there was this thing just hovering sort of 100 yards away. But I saw it so close – it wasn't in the sky or nothing... I could have hit it with a brick if I'd thrown a stone at it. I couldn't see the colours, because it was dusk – it was a good clear summer night... the sky was very clear. And round the bottom of it was just ordinary looking electric light bulbs blinking off and on alternately, like on a billboard. And on the top of it was a red light. The thing I noticed was that there was no noise – I could hear the freeway down below ... all the cars going. So I realised "Oh

it's not a helicopter – then it must be a balloon. It was so close to the rooftop, it couldn't be a balloon. So, all the rational things I went through... Not a helicopter... Balloon? Not a balloon – it's too close to the roof – and it's manoeuvring too well to be a balloon. So I just watched it and it was there for about 5 or 10 minutes and it went on down the East River and there it was. And that's all I am gonna say about it."

Apparently, May Pang wrote about this in her book and she gave an account matching Lennon's, [but she also added the following details](#)⁶⁵:

"We often had helicopters flying above us but this was as silent as the night and about seventeen storeys above street level." The object flew off but returned later, by which time she and Lennon had set up a telescope through which they could view it in more detail. "The light was so brilliant coming from the craft that no additional details could be seen. We did take a couple of pictures but they turned out overexposed." They also rang a local newspaper to report the sighting and were told at least seven other people had seen the UFO too.

"We even called the police, that's how excited we were, and they told us to keep calm, that others had seen it too." During what was left of the evening, John kept saying, "I can't believe it... I can't believe it... I've seen a flying saucer!"

The Moody Blues in "A Slide Zone"

We have seen two examples of overt references to UFOs/ET craft in popular music, so here we will look at a song which is probably about a UFO/ET related experience, but not confirmed to be so.

In an article in the Summer 1991 edition of *Flying Saucer Review* (FSR - page 16-17)⁶⁶, Pete Willsher, who worked in the music industry in a number of roles, including as a Studio session musician, described how he came to know of the account of [Graeme Edge](#)⁶⁷ who is the drummer in The Moody Blues. Graeme Edge was sharing a house with Pete Willsher's friend Robin Lumley (cousin of British female star Joanna). The event happened in Autumn 1967, when Graeme Edge was with the rest of the Moody Blues band. The Moody Blues have sold millions of albums around the world and supported The Beatles on their final UK tour in December of 1965. The FSR article included sketches of what was seen by Edge (though it is not stated whether these are Edge's or Willsher's sketches). Willsher introduces the article with an interesting comment.

There are a number of people within the film and music industries who have either had a sighting or some other form of UFO encounter. Many of these people, by virtue of the late hours kept as part of their professional day, are out either travelling or working late at night, often on lonely or deserted roads and locations, thus perhaps increasing their chances of an encounter.

Willsher reported Edge's account as follows:

We (the band) were returning to London after a concert in Carlisle. I'd like to point out straight away that, given the reputation of musicians for consuming alcohol and other (!) substances after a show, all the "Moody Blues" personnel were completely sober and straight. The road crew had, as usual, taken the equipment in the truck, and the band members were following

along by car. Apart from myself in the car, there were Denny Laine, Mike Pinder, Ray Thomas and Clint Warwick. Around about 1.30-2.00am we were driving south on the A6, when a bright light appeared and flashed past us. Everyone became highly excited as to what the light might be, with the usual nervous jokey references to "UFOs".

Personally, I was convinced it was probably an aircraft warning-light on top of a radio mast, apparently moving because of the motion of the car. However, the light returned from the opposite direction, and I suggested stopping the car for a proper look. I was still convinced of a logical terrestrial explanation.

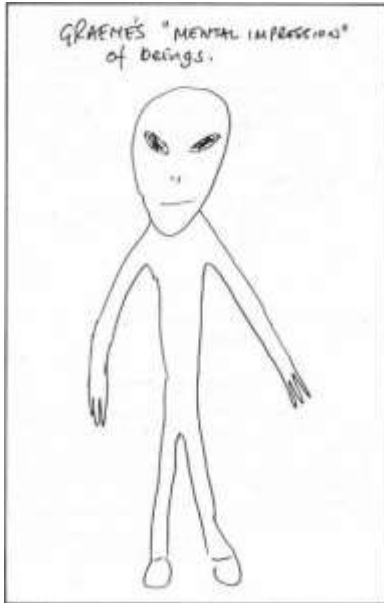
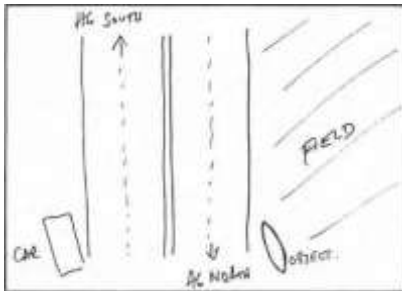
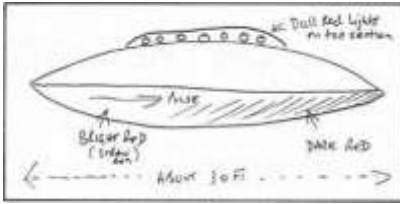

As the car halted, we all saw the light again to the left-hand side of us it went backwards and forwards, and then actually over the car before

settling in a field near the road, but on the opposite side of the dual carriageway. As we scrambled out of the car, half scared, half fascinated, we all noted an odd stillness around us. No road traffic came, in either direction, and there were none of the usual nocturnal animal rustlings or bird noises. It was quite uncanny and we were mesmerised as if in a dream. We could see the object in the opposite field; it was shaped like a fat cigar with a low protrusion on top, with seven dull red lights on it. I'm sure of the number, as I distinctly remember counting the lights at the time. The upper half of the object appeared metallic, whereas the lower half was red, and pulsed from left to right.

The lower half was a bright red on the left and a duller red to the right and did not seem to be metallic like the upper half.

Suddenly, all five of us were gripped simultaneously with dread and panic. We rushed back into the car, which started perfectly, and drove off. As we looked back, we could still see the object pulsing away in the field."

Willsher reported that Edge was quite happy discussing his account and Edge thought the other band members would talk about it too, even though Edge only told the story "two or three times" between 1967 and 1990. Willsher also reported that Edge didn't recall any "missing time", but, as is typical of

touring musicians, no-one bothered to check what time they arrived home.

Willsher said that Edge “was a changed man” because of the experience.

Willsher wrote that in 1967, the “Moodies” were a Rock/Pop band, but after this experience, they tended to write and release all kinds of “cosmic” albums, such as “Days Of Future Past” and “The Search For The Lost Chord.”

Willsher also describes the sketch (above) of the being, which was drawn because Edge was asked “What did the Aliens look like? (Ha-ha)” (though there was no mention of aliens in Willsher’s report. Edge drew something resembling a grey alien – though this is interesting because there were no drawings of these in 1967 and “Graeme had never read any literature on the subject.” Edge did the sketch because it “seemed like a fun thing to do.”

[A further discussion of a sighting by the band can be found in an article on the “Educating Humanity”⁶⁸ website. This article quotes from a 2014 interview with former Moody Blues member Michael Pinder⁶⁹:](#)

In 1966... with the first band, we were coming back from Manchester around midnight and we always wanted to get back to London before dawn, otherwise we'd have trouble getting to sleep. We were coming down from Manchester on the day they opened the M6 motorway. So we're driving home about one o'clock in the morning and I'm sitting in the back, and I'd put my head back and look out the back window and look at the stars. So we're driving and probably doing sixty miles an hour. There was this red light and I said, I don't remember that radio station around here. So I told the guys to pull over and we got out. We all looked over the top of the car and there was this red ball kind of thing moving across the freeway that turns into a square... like a red dice. As it approached us, it got bigger and bigger, and we were all sort of bathed in this blue light. We ended up getting home three hours late and wondering what the heck was that? ...So that really solidified my nickname of "Micky the Moonboy" as a kid. I was always interested in the moon... Read Zechariah Sitchin... he's the guy!

(We will be discussing Mr Sitchin later in this book!)

Pinder’s account seems like a different event – different year, different road and a different description. Did the band have more sightings that have not been discussed in interviews? [An article on “Earth Mystery News” is not the only place where it has been suggested that the Moody Blues may have been abducted.](#)⁷⁰ It also asks the question if the 1967 experience was the inspiration behind the 1978 song “Steppin’ in a Slide Zone”⁷¹ from the album “Octave” which was written by [John Lodge](#)⁷². It is quite easy to see why some have suggested this song is about an abduction experience:

*I took a ride in a limousine
I took a road I'd never been
I met a stranger by the way
His coat was torn but his eyes were clear
Standing in a slide zone
I could be steppin' in a slide zone
He told me where a river flows
He showed me how the apple grows
He told me of a magic stream
His face was worn but his eyes were clear
(Chorus)*

*He went to find a shooting star
Around the bend that's where they are
I went along just for the ride
Suddenly I began to glide*

(Chorus)

*The air raced by there was no sound
We drifted high above the ground
And then said you know this place
And then a smile lit up his face*

(Chorus)

*I turned my head and looked below
And there was something there I know
Suddenly I began to fall
I looked around and tried to call*

(Chorus)

*Help me please I thought I said
Then something happened in my head
Music came from all around
And I knew what I had found*

(Chorus)

The chorus also has various references to a “time zone.”

Katy Perry – E.T.

If we briefly look at [Katy Perry's song from 2011](#)⁷³, the [tone seems much darker](#)⁷⁴ than anything else we've mentioned in this section. Perhaps this is hardly surprising to those that have looked into the darker side of the music industry, such as [Mark Devlin in his “Musical Truth”](#)⁷⁵ books. Be warned - [the lyrics](#)⁷⁶ are quite disturbing

*You're so hypnotising
could you be the devil, could you be an angel
your touch magnetizing
feels like going floating, leave my body glowing*

*They say be afraid
you're not like the others, futuristic lovers
different DNA, they don't understand you*

*You're from a whole other/another world
a different dimension
you open my eyes
and I'm ready to go, lead me into the light
Kiss me, k-k-kiss me
infect me with your love, and fill me with your poison
take me, t-t-take me
wanna be your victim, ready for abduction
boy, you're an alien, your touch so far away
its supernatural, extraterrestrial*

And, yes, this is what kids had on their iPods and iPhones etc folks...! Oddly, the song was written by Max Martin, Lukasz Gottwald, Joshua Emanuel Coleman and Katy Perry. I will leave you to do your own research on this, while I “go to the cinema...”

Cinema Saucers and Aliens

Whilst most consider fictional films are primarily a form of entertainment, we can observe that the effect they can have, both on our conscious and subconscious mind, can be profound. Having read this far, I hope you are accepting enough of the idea that there is indeed a cover up related to the UFO/ET issue – and that it is something so important that influence may be being exerted over Hollywood, and the entertainment industry in general, whenever they are dealing with this subject. Again, if you want to read more about this aspect, refer to Robbie Graham’s book, mentioned earlier. Carl James has also written about influences in Hollywood in his book [“Science Fiction and the Hidden Global Agenda - Omnibus Edition.”](#)⁷⁷

We could probably fill several volumes just by *listing* and/or giving brief details about films and TV shows which are about UFOs, aliens and so on. Here, then, I will just “acknowledge” this dimension of the subject and offer a brief commentary on a number of films/productions – almost picked at random.

The First Alien Abductee?

Later in this book, we will take a detailed look at the alien abductee phenomenon, so I thought it might be worth mentioning here a fact that someone pointed out to me in 2011. Bugs Bunny “became” the first “alien abductee!” [In the Warner Brothers Cartoon “Hasty Hare” from 1952, Bugs Bunny is tied up by an “alien” and taken aboard a flying saucer!](#)⁷⁸ Whilst I can almost see you smiling as you read this, can we consider there might be a “stranger thing” going on beneath the surface? This is only 5 years after the Roswell Crash and in the middle of a time when everyone seemed to be talking about flying saucers... Perhaps it was nothing more than a comedic retelling of the George Adamski story (see chapter 8), but it did surprise me when I learned about this.

The Day the Earth Stood Still – 1951

I saw this film when I was about 10 years old and found it to be a compelling story – which was well-written and, for the time, very well presented – with special effects that were convincing enough to enable one to consider it might be a real event – that is, the effects weren’t so tacky that they made you laugh! (The 2008 remake starring Keanu Reeves is a good example of how the use of the most advanced CGI does not make up for other shortcomings in a film.)

The 1951 Robert Wise film is indeed thought-provoking, due to a combination of factors. [In the film,](#)⁷⁹ a flying saucer lands on the President’s Park Ellipse in Washington, D.C. (perhaps this was the start of the “White House Lawn landing” scenario that sceptics often ask about). The craft sits there for some time and is surrounded by soldiers and tanks. An alien, Klaatu (Michael Rennie) soon emerges, saying he is on a “goodwill mission.” He opens a small device, but as he is holding it out, he is shot and wounded by a nervous soldier and the device is destroyed. In response, Gort, a large

humanoid robot emerges from the ship and using a ray which emanates from his head visor, disintegrates all weapons present.

Klaatu is taken to an army hospital, where he recovers quickly (amazing doctors). He then talks to the US President's secretary – Harley - and states a message must be delivered to all world leaders. Harley says this is not possible and leaves Klaatu locked up under guard, but Klaatu escapes and befriends a woman named Helen Benson and her son. The story then has Klaatu learning about the deaths of soldiers in wars and he goes to see a scientist called Barnhardt, warning him that “that the people of the other planets have become concerned for their own safety after human beings developed atomic power.” Klaatu declares that if action isn't taken, “Planet Earth will be eliminated.” Klaatu later arranges a demonstration where all electrical power is cut for 30 minutes (although hospitals and similar places are not affected).

Klaatu is then chased, shot and killed by military personnel, but Helen has instructions to tell Gort what happened and she heads to the craft. Gort awakens, kills two guards then retrieves Klaatu's corpse and brings it back to the craft. Gort then revives Klaatu, who later steps out again and explains to the assembled crowd that humanity's violent nature won't be tolerated by other inhabitants of the universe, who have created and empowered a race of robot enforcers to control violence. He warns that the robots will destroy Earth if the violence continues, saying, “The decision rests with you.”

In their book “[Project Disclosure: Revealing Government Secrets and Breaking the Truth Embargo](#),”⁸⁰ pages 88-89, Bryce Zabel and Richard Dolan write:

*Some UFO researchers believe that the entertainment industry is part of the effort to acclimate the public to accept the concept of alien life. Hollywood, it has been argued, has collaborated with the intelligence community to release disinformation, and at other times leak a few details to prepare people for eventual contact with non-human life. Certainly, several 1950s movies look like CIA-sponsored attempts to deal with Roswell. Researcher Bruce Rux cited 1951's *The Thing from Another World*, considered to be the first realistic flying saucer movie, which reflected certain elements of the crash and recovery at Roswell [we will cover this in a later chapter] four years earlier. The film's maker, RKO, was up to its eyeballs in intelligence assets. It was owned by billionaire defense contractor and test pilot Howard Hughes, plus it was a subsidiary of Time-Life, which was owned by CIA-connected Henry Luce. The movie also captured the essence of the Top-Secret government study, *Project Twinkle*, which was then classified.*

Some of the other movies of the era look suggestive, also. Several key industry players had connections to military intelligence and later the CIA.

*Edmund H. North, the screenwriter of the 1951 UFO film, *The Day the Earth Stood Still*, had worked in the Army Signal Corps during the Second World War. It would seem that the secret-keepers wanted to float some trial balloons before the public, and that Hollywood producers were happy to oblige. If so, their message seems unclear.*

In the 50s and 60s, aliens in the movies were predominantly (though not exclusively) portrayed as rather evil – perhaps this was meant to reflect the

“Cold War mentality” of the times.

When I learned about the connections in Hollywood to the military and other interests, it did make me consider these films in a different light – i.e. I began to think that they weren’t just reflecting aspects of what was happening in the world at the time, they were *being used* to influence the way people thought about the issue. Zabel and Dolan have observed things in a similar way:

Although “The Day the Earth Stood Still” demonstrated alien tough-love, many other movies from this period were invasion-oriented. They included Earth Versus the Flying Saucers, Invasion of the Body Snatchers, and The War of the Worlds. Were these also examples of CIA influence? And were they the result of official policy, or some unauthorized leak? If there is continued intelligence community influence amid the out-pouring of ET-related movies today, it is even harder to know what the message is.

CIA influence and messages aside, I asked myself, having recently watched the 1951 film again, “Was it based on a true story, which actually all took place in secret at a US Air Military Base, between 1947 and 1950?”

Forbidden Planet

In 1956, another spectacular film was released – the story of which was loosely based on Shakespeare’s “The Tempest.” The scenario in this film is more “fantastic” than “The Day the Earth Stood Still” but interesting in very many respects – the first being that the Earthmen fly to another planet in a classic Flying Saucer!



The Earthmen’s flying saucer is shown bottom left...

Interesting aspects of this film are in relation to ideas about an advanced alien civilisation which destroyed itself when they developed technology to directly affect matter using their own thoughts.

It considers concepts of free energy, higher consciousness (and the darker side of this) and morality – as well as alien civilisations and space exploration. Of course, it has one or two corny scenes, but these are more than made up for by the solid storyline and dialogue, and impressive sets and effects, which again are more than good enough to transport the viewer to the alien world the film portrays.

Close Encounters of the Third Kind

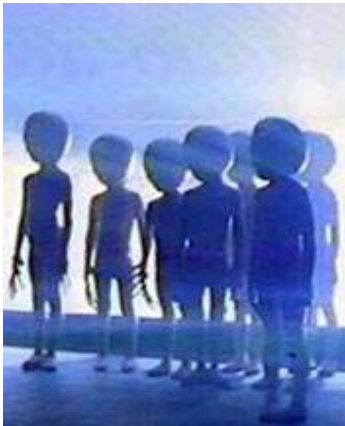

Following the massive 1977 success of “Star Wars,” Science Fiction films became a huge money-making opportunity. So, it was less surprising that so much money was spent on Steven Spielberg’s extraordinary film, the title of which came from [Dr J. Allen Hynek’s “UFO encounter classification list”](#)⁸¹. A “Third Kind” encounter is where a human sees or meets beings during a UFO encounter.

The film is centred on a character called Roy Neary who sights a craft at close range and he is “sunburned” on one side of his face by the effect of the radiation from it. He then becomes obsessed with the phenomenon and is plagued by visions of the Devil’s Tower in Wyoming, where the film’s finale is played out. Francois Truffaut played a character called Lacombe who developed a method of communicating with the aliens, using musical tones. The final scenes involve Lacombe (whose character was apparently based on the UFO researcher Jacques Vallee) directing communications with an enormous craft which hovers about 20 feet

off the ground. Following this communication, Roy Neary (played by Richard Dreyfus) boards the craft, having been greeted by what appear to be alien children.

It is certainly unusual that Spielberg was “allowed” to release a “Special Edition” of this film in 1980, which had additional scenes where Neary sees the enormous interior of the craft.

[Also of note is that Dr J Allen Hynek had a cameo role in the movie.](#)⁸²

The perception created in this film is one of wonder and excitement – and

that the benevolent aliens are involved in some type of benign exchange with humans – or that there has been some misunderstanding over certain instances (i.e. the disappearance and reappearance of a number of aircraft shown at the beginning of the film).

Some have suggested the final sequence was based on the Holloman Airbase landing/interaction, which we will mention again in a later chapter.

The mood and feel of the Close Encounters film seemed very different from Spielberg's 2005 remake of "War of the Worlds."⁸³

"ET" – The Extraterrestrial 1981

We mentioned Ronald Regan's statements about this film again in chapter 2.



The story in this film is straightforward enough – a group of children find an abandoned or stranded small alien in their neighbourhood and they look after him for a period of time. They discover the alien has magical powers. Of course, the authorities and military find out and take control of the situation and remove "E.T." from the children's care. Again, we see a theme of death and resurrection in this film

(as with Klaatu in the "Day the Earth Stood Still"). This is most obviously a children's film, but Spielberg described it thus⁸⁴:

Throughout, ET was conceived by me as a love story - the love between a teenage-old and a 900-year-old alien. In a way I was terrified. I didn't think I was ready to make this movie; I had never taken my shirt off in public before. But I think the result is a very intimate, seductive meeting of minds.

This film also seemed to have an enormous effect on the public psyche, and then caused people to repeat the phrase "E.T. phone home" in relation to stories of UFOs and aliens. The film was also mentioned by Ben Rich, former head of Lockheed Skunkworks in a lecture he gave in 1993⁸⁵, when he said of Skunkworks "We have the technology to take E.T. home."⁸⁶ In chapter 2, we discussed how Spielberg met with Regan in the Whitehouse, to show them the ET film and Regan stated to the group that was present that "everything on that screen is true." Bill Cooper, in a 1989 lecture he gave in Arizona⁸⁷, stated that the story of ET was actually based on the story of an Extraterrestrial Biological Entity (EBE) that was captured following the 1949 crash of two discs – again near Roswell, New Mexico. Cooper stated that the EBE was from a "technologically advanced" race and an Air Force Officer was assigned to supervise the EBE and communicate with him/her. After some time, the EBE became ill and so, as part of an alien communications project, "Sigma,"⁸⁸ a message was sent out into space to ask for help. The EBE later died, and the Air Force Officer cried – that is, the story is the same as that of the film, but "Elliot" (the young boy) was in real life an Air Force Officer. As far as I know, the Cooper account came out before Spielberg's revelations.

Independence Day - 1996

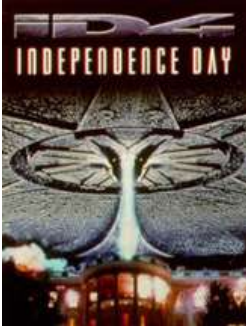

It is easy to view this film as PR or propaganda for US military forces, the storyline being that a hostile set of huge alien ships invade the earth and destroy a number of famous buildings.⁸⁹ In about 2009 or 2010, I made a short video which included Dr Carol Rosin's statements from the 2001 Disclosure Project conference about "the extraterrestrial threat" and "threats of terrorists" (both of which are/were/would be based on lies).⁹⁰ I used a few seconds from the "Independence Day" film, showing the destruction

of the Empire State Building and compared it to the destruction of the WTC on 9/11 (See below).



Destruction of Empire State Building in "Independence Day" Film



Destruction of WTC 2 on 9/11 in real life.

In another eerie scene from this film, there is a countdown timer, which is shown when Jeff Goldblum opens his laptop computer. [The timer changes from 9:12:00 to 9:11:00 immediately before a cut to another shot.](#)⁹¹ It is difficult for me to interpret these images as anything other than some kind of foreknowledge of events which would take place five years after the film was released. [Others have noticed many similar 9/11 references in other films](#)⁹², a few of which I mentioned in chapter 28 of [9/11 Holding the Truth](#)⁹³.

"Contact" – 1997



This film starring Jodie Foster as an Astronomer, Dr Ellie Arroway, was based on a 1985 novel by Carl Sagan ([the only non-fiction book he authored](#)⁹⁴). [In the film](#)⁹⁵, Arroway picks up messages from space which turn out be plans to build a machine, to allow interstellar travel. However, the machine isn't a spaceship – but some kind of jump gate or portal. In the story, the machine is built, but destroyed by "an act of terrorism." However, it turns out that a duplicate has been built in complete secrecy, and Arroway

(Foster) is then given the chance to use this machine to travel – in a pod - through some kind of dimensional portal, to the region of the star Vega. Following some kind of incident where the pod is damaged, Arroway ends up on a strange beach. Here, she meets some type of ethereal or alien being, who has the appearance of her father (who died when she was 9 years old.) A conversation takes place, but after a few minutes, she is then transported back to the earth. There is doubt over whether the story she recounts on her return was the result of some kind of hallucination or dream she experienced when she was involved in the incident which damaged the pod, or whether it was a real event. A recorder that was running in the pod during the trip recorded 18 minutes of static.

In this film, then, the main themes seem to be about ET life, consciousness and “dimensional travel.”

I have come to the conclusion that Carl Sagan knew quite a bit about the UFO cover up. I gave some reasons for this in chapter 23 of “[Secrets in the Solar System.](#)”⁹⁶ We will mention Dr Sagan again in chapter 4.

“Paul” - 2011



By the time I came to see this film, I was already aware that the UFO cover up was, in part, being helped by Hollywood productions. However, I found this film to be very enjoyable – with plenty of humour and “in-jokes” for those (like me) who are fans of the Science Fiction

Genre. The film, written by and starring Simon Pegg and Nick Frost, could be described as “ET for adults” and is very well done. The story is simple in that while touring Nevada, Frost and Pegg encounter an escaped alien, who was formerly held in Area 51. He joins them in their “motorhome” and they continually try to evade capture by the US intelligence services. With help, Paul eventually escapes on a craft that comes to collect him. “Paul” is a benign and “cool” alien – with the ability to heal, restore life and make himself invisible for short periods of time.

Whilst the film is very funny in places, and parts of the plot are silly and unrealistic, it nevertheless touches on some very serious themes, such as expanded consciousness and healing. One notable scene, after the character Ruth Buggs has been shown (by Paul’s use of “tactile second connect bridge,”) she says to Simon Pegg’s character:

“So everything I’ve been told my whole life is just a big fat lie...Do you know how that feels...? [Pegg makes a pun on “the truth”] So there’s no heaven... no hell, no right, no wrong... no sin?”

I was pleased to see these sorts of concepts presented in this film, but again, it’s all just a (smutty in places) Science Fiction comedy, of course...

“They Live” – 1988

I didn’t hear about this John Carpenter film until probably 2004 or 2005 and therefore I never realised the significance of some of the plot elements it contains. A character called John Nada discovers a pair of “sunglasses” which allow him to see through the “veil of reality.” He suddenly learns that people in the world around him are, in fact, being given subliminal messages all the time in all consumer advertising and imagery. Nada (played by Roddy Piper) can also see, when he wears the glasses, that roughly half the population are actually rather ugly aliens. As the story develops, Nada and his associate, Frank, learn that a group of aliens are running affairs on planet earth. They infiltrate a secret dinner meeting, being taken for members of the “Power Elite.” As they explore the building they find themselves in, they pause to listen to a speech being given by one of the aliens, to the assembled group, who are sitting around dinner tables. The dialogue here is particularly interesting to me.



Our projections show that by the year 2025, not only America, but the entire planet, will be under the protection and the dominion of this power alliance. The gains have been substantial – both for ourselves – and for you, the human power elite.

You have given us entrée to the resources we need in our ongoing quest for multi-dimensional expansion - and in return, the per-capita income of each of you has grown, in this year alone, by an average of 39%.

This dialogue is even more interesting in light of [statements made by John Carpenter in a 2015 interview](#)⁹⁷. The interviewer suggests

the film is really a commentary on the “Regan years.” Here is a small portion of that interview.

“They Live” was a reaction to the Reagan years, but the income inequality, corporate ownership of the media — all of that is more extreme now than ever.

*Yeah, it is. You have to understand something: **It’s a documentary. It’s not science fiction.***

Of course we can always draw parallels between the content of science fiction films and the current political struggles of the day (e.g. some people suggest that the Klingons in Star Trek represented the Soviets or Communists). However, this does not really explain the use of the phrase “multi-dimensional expansion” in the film’s dialogue, noted above.

Conclusions

There is no doubt that the themes of extraterrestrial life, aliens and space travel resonate strongly and deeply in a large proportion of the public. The

popularity and longevity of shows like Star Trek shows this in a powerful way. Perhaps it becomes obvious then that the secret keepers will exert influence to insert ideas and themes into science fiction media, at any suitable opportunity which will help them to influence the minds and shape the perception of all people who consume such media.

In the next chapter we will look at a few other aspects of the way perceptions of UFOs/ETs are managed in the wider population.

4. UFOs? Aliens? Do Me a Favour, Ha!

In this chapter, I will highlight some of the common challenges to those that want to encourage a serious study of the UFO/ET evidence by those not familiar with it. As I have said elsewhere, trying to directly convince someone of something like the reality of UFO/ET-related events is rarely successful. If you “preach” to them or say something like “You need to look at this!” your good intentions are, of course, likely to be met with disinterest, resistance or even anger. In rare cases, this might be because the person has already had experiences or knows certain things, but they have not been able to accept the reality of them – i.e. they are in denial or in a state of “cognitive dissonance.” Another consideration is their “state of consciousness,” which I will touch on in later chapters. Alternatively, they may have other reasons for not being able to talk about it – because they have taken an oath or made an agreement with fellow witnesses or experiencers.

In my experience, people are only receptive to unusual or uncomfortable evidence if they are curious enough to approach *you* and ask *you* something about it, or if they share their experience with you openly. On the other hand, some people are so open-minded, their “brains may have fallen out...” and so will “almost believe anything.”

In the following discussion, we will touch on a few significant UFO/ET cases and a few of these will be covered with a little more detail in later chapters. The objective is to highlight significant details about significant cases and then encourage the reader to study said cases further, using the links or references provided.

“So Why Haven’t They Landed in Broad Daylight, for All to See?”

This is a very common point that is made – often in the form of “Why haven’t they landed in front of the Whitehouse?” It is true that there haven’t been landings in a major city, in front of thousands and thousands of people. Some people think that, because this hasn’t happened, they can’t take the idea of UFO’s and aliens seriously. However, this, again, is because of how they make assumptions – based on their perception and knowledge of the world (which, I suggested earlier, has been managed).

Evidence can be gathered that these craft have landed in broad daylight and people have witnessed them - even made contact with the occupants. People, if they wish, can study the details of the old [George Adamski Case](#)⁹⁸, [Sixto Paz Wells](#)⁹⁹ case (see chapter 8) and even [the apparition at Fatima, Portugal in 1917](#)¹⁰⁰. However, most of the testimony to these sorts of events is dismissed as lies or fantasy.

No, a saucer has not landed on the Whitehouse Lawn. There could be many reasons for this – and I, like over 99% of the rest of the earth’s population,

don't have the security clearance to know more about these reasons. Hence, all I can do is reference what I have read.

Some have suggested that ET races are benign and advanced and that if they were to land in a glaringly obvious way, it would be too shocking for the majority of us to bear.¹⁰¹ Others suggest that the ET's want to operate secretly for their own reasons, so it is not in their interests to openly reveal themselves. Is it silly for me to include such speculative “nonsense” here? Perhaps.

But let us not forget that there were [significant events in the skies over Washington DC in 1952](#)¹⁰², which simply were explained away and people quickly forgot about them, despite the fact that [these objects were tracked on RADAR](#)¹⁰³. (At least one was reportedly shot at as well).

Ten years earlier, in February 1942, an event which was later nicknamed “[The Battle of Los Angeles](#)” seemed to involve a large object, illuminated by multiple, powerful war-time searchlights, being subjected to a barrage of anti-aircraft fire whilst it was hovering near the city¹⁰⁴. Was it all just a mirage...? The photograph seems to suggest otherwise...



1942 – “Battle of Los Angeles”

Similarly, there have been many daylight sightings in Mexico and South America – for example [during the total solar eclipse of 11 July 1991](#)¹⁰⁵. (However, some claim [the videos of this object were just of the planet Venus](#)¹⁰⁶, or perhaps Mars. Problem is, the features of the objects in the videos don't match those of Venus or Mars under normal viewing conditions and observation of planets during an eclipse is somewhat hampered by ambient light from outside the region of totality.)

Another significant mass sighting, which took place during an “astronomical event” was the sighting of the so-called “[Phoenix Lights](#)” on 13/14 March

1997 in Phoenix Arizona¹⁰⁷. At the time, more people than usual were out looking at the night sky, due to the presence of Comet Hale/Bopp. Witnesses described seeing an enormous craft float silently above them¹⁰⁸. So, it isn't really true to say that large numbers of people, living in or near a big city have not had a sighting... Similarly, readers can also study the "Stephenville Lights" case which happened in the Texas town of the same name, in January 2008.¹⁰⁹

Interstellar/Intergalactic Space Travel or Faster than Light Travel is Not Possible so no ET's could be here.

We live in a "technologically advanced" society and there is something of an implicit view among many people that "we understand everything" and "anything which does not fit our understanding is not real". People whose job depends strongly on a "scientific view of the world" are normally the most guilty of referring to Einstein's theory of relativity to "debunk" the evidence that craft have already landed here, many times. Also, perhaps, they may suggest that any given "UFO event" is not reproducible in a laboratory (therefore is not worth taking seriously.) Of course, any leaders in any fields of science, business or politics, who were to admit that they didn't understand something, or they can't explain it, are perceived as showing a weakness. In many cases, however, it is a weakness of not being able to tell the truth, however uncomfortable it may be.

Currently stated "mainstream" laws of physics seem to dictate that (Faster-Than-Light) FTL travel (in a given medium) is impossible. However, if you were to study things such as the history of anti-gravity research (covered in my earlier "Finding the Secret Space Programme."⁴² book), you will find some evidence that strongly suggests we should not accept the stated laws of physics at face value. Similarly, multiple cases have been recorded where witnesses report craft making impossible manoeuvres. Some of these have been recorded on radar. Objects are seen to *break* the laws of physics by, for example, making right-angled turns at enormous speed, or simply disappearing into thin air. One example you can look at is a video shot in Kelowna British Columbia in 2003 – where a UFO changes shape and disappears¹¹⁰. There is nothing to suggest that this video isn't real.

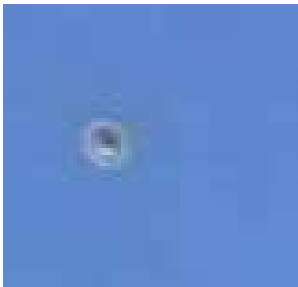

This object appeared, changed shape and illumination, then disappeared. The brief dialogue on the video suggests it is authentic!

It is of course far easier to dismiss the witnesses as bad or deluded observers and the photo and video evidence as faked than it is to accept an intelligently controlled craft has been piloted in our skies by non-human beings.

Weighed against this, we have to consider how certain earth-based technologies (e.g. microelectronics and digital technologies) have advanced tremendously. (It is then worth considering how some technologies - such as those used in most modes of transportation - have only seen incremental developments in about 100 years.)

If one accepts that UFO/ET visitation is a reality, it forces a complete change of “World View” in the most fundamental and far-reaching way and this, in itself, can be a subconscious reason for rejecting the validity of any testimony or evidence which is presented. (Some have suggested that this is like when Galileo discovered the moons of Jupiter, therefore proving that not everything went around the Earth. There were those who refused to accept his evidence by simply not looking through his telescope.)

Hoaxing, Hoaxers and Hoaxes

It is true that there are a fair number of “proved hoaxes” in the UFO and similar fields. Some would accuse figures like [Eric Von Daniken](#)¹¹¹ and George Adamski of promoting false or misleading information, or just being “plain wrong.” However, a more detailed study of these figures reveals a more complicated picture (some of which we will cover in later chapters). Also, it seems that certain key cases have been interfered with – even to the point of fake witnesses being introduced to tarnish the evidence. This is what happened in the case of [the 1997 “Sheffield Incident,” investigated by Max Burns](#)¹¹², and it also happened with [Travis Walton’s case \(this is discussed in his book, “Fire in the Sky”\)](#)¹¹³.

It is worth bearing in mind, however, that hoaxes are widespread – and not just limited to the fields of UFOs, ETs and the “paranormal.” I can site examples such as the [Hitler Diaries](#)¹¹⁴ that have been perpetrated; yet is it then the case that all other historical personal diaries are then immediately and automatically assumed to have been falsified? (This is often the case with UFO/ET related testimony and evidence.)

Additionally, when there is testimony that someone has been up Mount Everest, and they offer photographic evidence, it is unlikely they are closely questioned or that we put a great deal of effort into *disproving* their story, even though there is some conjecture that at least one account of an ascent to the summit of Everest may not be valid ([I refer to a 1960 ascent by a Chinese team](#))¹¹⁵.

My thrust is to say that just because one or more hoaxes have been carried out is not a good basis for automatically dismissing all the other Witness Testimony and evidence.

In more recent times, the mainstream news has also exaggerated or mis-reported many non-UFO stories – to the point where this could be called “hoaxing.”

People who are Recounting/Dealing with UFO Experiences are Out to Make Money

Again, this is *sometimes* true, but is not the sole reason for witnesses giving testimony. In many cases, their lives are changed – and usually for the worse. ([Listen to Robert Jacob's Testimony](#)¹¹⁶, for example. He has never written a book and neither has he given that many public talks.) Many UFO researchers and witnesses do not make any money at all from the evidence they present – a version of this book is being given away for free too!

Also, this accusation could be said of celebrities who write a cook book or autobiography. Have they made everything up? Which recipes did they steal from others? Which parts of their life story did they make up? If they go on TV or radio to promote their book, video or film, they are not immediately cross-examined with the assumption that they have simply “made up” whatever is in their book. The UFO/ET subject normally gets “special treatment” in this regard – due to the success of perception management strategies, discussed earlier.

“I Can't Believe the Cover-Up Would Be So Big. I Don't Believe in Conspiracy Theories.”

I was much more sceptical of “conspiracy and cover-up theories” before reading “Disclosure Project” material and devoting much time to an intense study of other available materials. People who cannot see a motive for things being covered up or suppressed will not bother to look for evidence that this is, indeed, what has been happening – on a grand scale. (I have written about this in my 9/11 books, for example.)

A very good way to cover something up is to create vast quantities of misinformation and mix this in with valid, legitimate claims. It then becomes very difficult to distinguish between truth and lies. We will be seeing, later in this book, how UFO and alternative knowledge researchers have been used (sometimes willingly) to promote false information.

It is sometimes suggested that if the truth that “Disclosure” points to was “officially” revealed, there would be public hysteria, as there was said to have been in 1938 when Orson Welles’ “War of the Worlds” radio programme was taken (by some) to be a live report of Martians invading New Jersey.¹¹⁷ However, the truth about the public reaction to that broadcast seems to be that people weren't really “running through the streets screaming.”¹¹⁸

The risk of mass hysteria is suggested as one reason why “official” revelation has been avoided. However, more significant reasons for the cover up relating to UFOs and ETs are to do with energy and defence interests – ET craft, it

seems clear, don't run on petrol or other "fossil fuel" variants! (I discuss relevant research in these areas in "Finding the Secret Space Programme."⁴²)

It was in the "Disclosure Project" Testimony that I first saw the links between UFOs/ETs and "free energy" and anti-gravity technology. For most of the 20th Century, various people have come forward to say they have discovered "free energy" of one kind or another - Nikola Tesla¹¹⁹ is probably the most well-known example, though he is more commonly associated with "conventional physics." (He was the inventor of the Alternating Current (AC) method and system of transmitting power and the unit of Magnetic Flux density is also named after him.)

If one accepts that craft have crashed and have been recovered by the military, then it follows that those same military groups are in possession of advanced technologies. Disclosure testimony discusses the treatment of anti-gravity propulsion¹²⁰ and "free energy" technologies. As US Air Force, NRO Operative, Sergeant Dan Morris (who sometimes used the name Dan Salter) stated in an interview with Steven Greer:¹²¹

UFOs are both extraterrestrial and manmade...It's not that our government doesn't want us to know that there are other people on other planets. What the people in power don't want us to know is that this free energy [from energy generators developed with UFO technology] is available to everybody. So secrecy about the UFOs is because of the energy issue. When this knowledge is found out by the people, they will demand that our government release this technology, and it will change the world.

Essentially, we know this is true – because of the facts that most researchers won't even discuss. That is, what happened to the WTC on 9/11, which I have discussed in my other books. We will revisit this issue later.

If you don't believe how large some of the covert projects can be, consider the details of one project, Project Orion¹²². It had considerable funding and planned to build a large ship to be "blasted" into space using atomic bombs¹²³.

If the Reality of UFO/ET Visitation is a given, then How Can the Existence of NASA and, for instance, SETI be Explained?

The conventional, (perception-managed) orthodox view is that "we still do not know for sure of the mere existence of any extra-terrestrial life".

Additionally, the basic view is "there is no real proof that any extra-terrestrial life has ever visited the Earth". As I have already stated and shown, views other than this, at best, have not been taken very seriously or are just taken to be fiction, and, at worst, have been ridiculed and denied since the 1940s.

Therefore, they are generally not accepted by orthodox thinkers (who make up the bulk of the scientific establishment). This means that though there are people who are sceptical of the existing evidence for UFO/ET visitation – and covert knowledge of this and related matters – there are still people who are curious about evidence of life elsewhere in the Universe. They, just like the rest of us, seem to share a need to answer the question of "are we alone in the

cosmos?” Otherwise, why would probes have been sent to the moon and planets etc? Again, we encounter complexities in addressing these issues – as I wrote about in detail in “[Secrets in the Solar System: Gatekeepers on Earth](#)¹²⁴.”

To my way of looking at things, the SETI initiative (and all similar ones) just form part of the fabric of perception management regarding the evidence of UFO/ET visitation (more on SETI later...)

“If this stuff is so highly classified then why can I find it so easily on the Web?”

As I have continued to research the UFO-related evidence and also observe the way certain researchers have behaved, the way I answer this question/comment has evolved over the years.

With the advent of smartphones and similar devices, which have in-built recording capabilities (some of them quite advanced), it is now easier than ever for people to record anomalous sightings. By and large, most of the recordings of anomalies that we see are seen at quite a distance from witnesses and the details are difficult to make out, so there are only a few videos and photos that are really compelling.

The major incidents and cases, such as Roswell, Rendlesham and similar ones have so much “noise” around them now that most people don’t have the time or ability to filter out this noise. Millions of YouTube videos are now available, for example, but how many demonstrate a good quality investigation of the available evidence?

So, the simple answer is related to what was discussed earlier – whatever “good” evidence is available to study, most people have already been “perception managed” to the point where they assume the evidence cannot be significant – because if it were, they would have been told *properly* or *truthfully* about it by mainstream sources.

A More Conventional View...?

As I cover at length in “[Secrets in the Solar System: Gatekeepers on Earth](#)¹²⁴,” I regard most of the “conventional evidence” regarding things like [extra solar planets](#)¹²⁵ and [water and Life on Mars](#)¹²⁶ as a kind of “limited hangout” and, as I demonstrate in the book, conventional research has only progressed incrementally in the last 40 years. Yes, of course, the probes have gone further and given us a greater amount of data, in higher resolution, but we have not been told of any major discoveries in mainstream science and commentaries.

A term which has occasionally appeared in mainstream science is “[Panspermia](#)¹²⁷.” It relates to a theory that life on Earth did not originate here – this theory was developed when it was realised that no current scientific theory properly explains how life started on earth so quickly after its formation. Few people are aware that in 1973, [Francis Crick, co-discoverer of the structure of DNA, had a paper published in the Icarus journal regarding](#)

Directed Panspermia – the theory that life was *brought* to the earth deliberately¹²⁸.

Another concept discussed in mainstream material about the possibility of extraterrestrial life is [the Drake Equation](#)¹²⁹, which is an attempt to quantify the number of technologically advanced civilisations which could exist in our



galaxy. Following an academic thought process, based on statistics, the terms in the equation are all values which are multiplied together. None of the values for terms in the equation are known with any accuracy. Of course, none of the terms or basis of the equation considers or relates to any of the evidence discussed in this book

or similar evidence discussed elsewhere. (We can also note here that [Drake won a Navy Scholarship](#)¹³⁰, but only served for a few years before working in astronomy. The US Navy link could be important, as they seem to be heavily involved in the cover up of knowledge about extraterrestrial life, as I mentioned at several points in the “[Secrets in the Solar System: Gatekeepers on Earth](#)¹²⁴” book.)

Again, the conventional approach and attitude seems incapable of dealing with the really big questions and the strongest evidence. Even when conventional science seems about to reveal something truly significant, it then withdraws, shirks and “fades away”. Here is an example from 2003, which came to nought, or at least, there was no follow-up that I became aware of and people like [Seth Shostak](#)¹³¹ are still saying similar or exactly the same things as they were saying in the 1980s.

From: SETI Web [setiweb@ssl.berkeley.edu]

Sent: 20 March 2003 19:02

Subject: SETI@home news bulletin

Dear ADJ:

This is an exciting time for SETI@home. On March 18-20 2003 we travel to the Arecibo radio telescope to re-observe the most promising “candidates” produced by our search so far. There is a chance that these new observations will yield the first real evidence of extraterrestrial life. Thanks for being part of this history-making effort! According to our records, you have processed 206 work units, the most recent on March 16, 2003. Your contribution of computer time to SETI@home is greatly appreciated. Support SETI@home –

Join The Planetary Society

Without the unwavering support of The Planetary Society, we would not be embarking on this round of re-observations. We strongly urge all SETI@home users to join The Planetary Society and help keep our project alive. If you join now, you'll receive a free poster titled “Is Anybody Out There?” featuring an evocative image of the millions of stars near the center of our galaxy. Go to: <http://planetary.org/html/member/SETIoffer.html> The Planetary Society supports

several different searches for extraterrestrial intelligence, as well as extra-solar planet research and many other worthwhile projects. For a look at the full range of their activities, visit <http://planetary.org>

Thanks also to our other major sponsors: the University of California,

Sun Microsystems, Network Appliance, Fujifilm Computer Products, and Quantum;

and to individuals around the world who have generously donated to SETI@home:

see <http://setiathome.berkeley.edu/donor.html>

Scientific News

With the help of participants like you, SETI@home has analyzed

about 10,000 hours of data from the Arecibo radio observatory,

producing a database of several billion events

(spikes, Gaussians, pulses, and triplets).

From this database, we have extracted the “candidates” that,

in our judgement, have the greatest likelihood

of coming from an extraterrestrial synthetic source.

The factors in this evaluation include:

- Signal power
- Goodness of fit
- Detection several different times
- Proximity to a nearby star, especially one similar to our Sun.

Our next step is to re-observe the top candidates by pointing a radio telescope at that location in the sky and checking for a similar signal. We applied for telescope time at Arecibo and were granted 24 hours, in three 8-hour chunks on March 18-20, 2003. If everything goes well, this will be enough time to re-observe about 150 candidates.

The re-observations will be done using the main receiver at Arecibo, which has a smaller beam and greater sensitivity than the antenna we normally use. We'll record the re-observations on magnetic tape, both in our usual format of 2 bits per sample, and in a higher-resolution format with 8 bits per sample. Then we'll analyze the recorded data in three ways:

- We'll do a fast analysis using computers at Arecibo;

this will guide us in choosing candidates on which to spend more time.

- We'll analyze the 2-bit data using the current SETI@home client; this will take place during the week or two after the Arecibo visit.

- We'll analyze the 8-bit data using a new client program based on BOINC (see below), yielding better sensitivity.

This will take place a month or two after the Arecibo visit. More information on the re-observation project is here:

<http://planetary.org/stellarcountdown/>

Project News

The re-observation is just one of the things keeping us busy. We have built a new data recorder capable of handling the 13-channel multibeam receiver at Parkes in Australia. This will produce data for our new “Southern SETI@home” project, which we hope to start later this year if we can raise the necessary funds. In addition, we are preparing a new distributed computing project, Astropulse, that will analyze our current SETI@home data, looking for evidence of evaporating black holes, fast pulsars, and

new types of ET signals. See <http://www.planetary.org/astropulses.html> Our upcoming distributed computing projects will use the Berkeley Open Infrastructure for Network Computing (BOINC), which we are developing with support from the National Science Foundation. See <http://boinc.berkeley.edu>. BOINC will also be used by science research projects in other areas, such as molecular biology and climate prediction. BOINC lets you choose how much computer time to devote to each project. The transition from SETI@home to BOINC will be gradual. We'll continue to record new data at Arecibo even while BOINC ramps up; for now you can help us most by continuing to run SETI@home. Whether or not the re-observations find an ET signal, SETI@home has been a tremendous success and a lot of fun. We are very grateful for the participation and enthusiasm of our users all over the world, and we look forward to continuing working together to investigate the mysteries of the universe.

Dr David P. Anderson

Project Director, SETI@home

<http://setiathome.berkeley.edu>

Academia on ET

Figures such as Seth Shostak and the late Carl Sagan have, over many years, frequently appeared on many documentaries regarding either UFOs in general, or mainstream thinking relating to exobiology and extraterrestrial life. (In the “[Secrets in the Solar System: Gatekeepers on Earth](#)”¹²⁴ book, I discussed the connection of Carl Sagan to the US military and several peculiar statements he made over the years, some of which related to his involvement in a UFO research symposium which was held by the AAAS in the 1960s.) In all cases, they have essentially ignored the details of all of the prominent UFO/ET cases – a few of which are mentioned in this book.



Carl Sagan in the 1970s or 1980s



Seth Shostak in the 2000s

Shostak had an article published on “[Space.com](#)” on 3rd November 2005 (although not under the title he chose)¹³², in which he concluded:

While ghostly ghouls and chats with departed relatives are one thing, scientific proof of a major new phenomena is something else. So I'm trying to look on the bright side. Despite years of "The X Files" and Fox specials, the public seems less prone to believe that aliens are visiting Earth. That, at least, suggests that the analytic reasoning of science may be making a bit of headway.

This caused me to write to him on 6 November 2005, via the SETI website, pointing out that SETI needed to pay more attention to the testimony of

people like the astronauts [Gordon Cooper](#) and [Edgar Mitchell](#) (I included [relevant links](#) – this was before I knew what Dr Edgar Mitchell was “about” – see chapter 27 of the [“Finding the Secret Space Programme”](#)⁴² book):¹³³ Shostak responded on 11 Nov 2005:

As for your suggestion that (1) we should believe testimony when it's given by astronauts, and (2) SETI should broaden its scope, I won't address the former, as it suggests that, just because someone is trained to fly the Space Shuttle, their word is a substitute for objective scientific evidence. That's silly, and it's not science. As for (2), it is not SETI's mission to investigate claims of sightings of alien craft around Earth. We do a different experiment, one that could be quickly checked by any number of observers and observatories. If I suggested that MUFON, for instance, should broaden its activities and do detailed radio searches of F through K star systems, would you think that a major desideratum? I suspect not.

Once again, Shostak ducked the evidence – [as he did in a debate with Stanton Friedman, a year earlier](#)¹³⁴.

This shows that people like Sagan and Shostak *have* to deny, downplay or ignore the available evidence, because they are just part of the perception management/cover up apparatus and mechanisms.

Considering Witness Testimony

Whole branches of Psychology are devoted to people’s perception of events and how they can be changed, distorted etc. It seems to be the case, as has already been touched on, that when witnesses describe unusual events, there is a basic (and/or subconscious) assumption that their testimony cannot be valid. Whole edifices of thought and conjecture are constructed to give reasons to suggest the literal meaning of the testimony may not be valid. Most of this edifice can, in many cases, be toppled with the simple statement of *“Well, you weren’t there – you didn’t experience it.”*

Let us simplify the thought process behind judging the validity of witness testimony. When considering any witness testimony, you have the following “stages of acceptance” (or non-acceptance)

1. Is this person “telling the truth”?
2. Have they “correctly perceived” what they saw, i.e. not mistaken it for something else?
3. If they do not seem to be lying and appear to understand what they saw, if I had been stood with them at the same time, would I have perceived what was seen in the same way as the person did?

If you feel you can answer “yes” to all 3 of these questions, then you accept that what the witness describes did actually happen, in that way, and it was a real event. In the list of 3 stages above, different people have different “jumping-off points”. (Obviously a great many factors *can* come in to play in making a decision about point 1, but in quite a few cases, I would argue that too much emphasis is placed on the various factors and there is too much resistance to the idea of saying “yes – they really *are* telling the correctly-perceived truth”.)

Psychologists and others can come up with a coherent and scientific explanation of why someone's perception may be altered but again, I regard this as a kind of "cognitive safety net", because the honest and simple answer is often "This person is not lying and did not mis-perceive, they saw something which is clearly beyond our current understanding but it is, nonetheless, very real." This sort of statement is rather unpopular because it is an admission of an inadequacy of understanding or an acceptance of a "wider reality" than we commonly experience. This opens up a curious paradox because science is supposedly a process of finding the answers to questions and yet the questions raised by the UFO and ETI topics I am discussing here seem to be actively discriminated against.

Since the 1960s, it seems to have become harder (or even impossible) for mainstream scientists to publish serious material about the UFO/ET issue. Most of the current literature is, again, "limited hangout" in nature, such as [books by Dr Paul Davies](#)¹³⁵, [Jim Al-Khalili](#)¹³⁶ and [Michio Kaku](#)¹³⁷. I would be very surprised if any of those books mention, with any seriousness or sincerity, the sort of evidence discussed in my books.

Back in the 1960s, a few scientists such as [Dr J Allen Hynek](#)¹³⁸ and [Dr James E McDonald](#)¹³⁹ did research the UFO/ET issue in a serious and dedicated manner and they spoke candidly about their conclusions. Hynek in particular became much less sceptical, following years of ongoing research and investigation.

The Gatekeepers... Again

Even with a relatively small amount of study of recent history, it should become clear that the UFO/ET subject will not be appropriately treated by mainstream science or government agencies or bodies. Hence, in studying the available material and evidence, you are "on your own." Additionally, a fair number of UFO/ET researchers and groups are also, in many cases, operating on a "limited hangout" basis and won't ever talk about free energy technologies or weaponisation of them. They too, when shown evidence of these truths, won't discuss them in their ongoing presentations and articles. We will study this situation a more closely in a later chapter. Some researchers also don't seem willing to correct mistakes they make when they are advised of them (e.g. they continue to talk about the Apollo Lunar landings as if they were real events).

5. UFO/ET Landings and Crashes

Once you start to look for evidence, you can find quite a number of cases, from all over the world, where it seems that some kind of non-terrestrial craft crashed or landed.¹⁴⁰ In 2006, Dr Robert Wood and his son Ryan produced a book called *Majic Eyes Only*¹⁴¹, listing the evidence for UFO/Saucer crashes and giving their estimate on the likelihood of each case being true. Here, I will briefly cover some of the cases I have become familiar with, over the years.

When I have mentioned the subject of UFO crashes in postings or presentations, people sometimes say “I can’t believe that aliens, with such advanced technology that they can make interplanetary or intergalactic journeys, would just crash here on earth. How could that happen?” It’s a fair question. However, it is a question which assumes the craft crashed because of bad piloting. Once again, people jump to the “why” question before looking at the evidence of “what happened.” Jumping to the “why” risks bypassing the available evidence – showing that, indeed, craft have both crashed and landed. Research into the circumstances of some crashes suggests the answer to the “why they crashed” question seems to be that the craft have been shot down or brought down. In the cases of the ones in New Mexico in 1947, some researchers have suggested high-powered RADAR was used to interfere with the crafts’ guidance or propulsion systems and it was this that caused them to crash.

Roswell, New Mexico, June or July 1947

It seems that more books have been written about this case than any other and I would direct the reader who is unfamiliar with the case to the following resources:

- [Witness to Roswell by Tom Carey and Don Schmitt](#)¹⁴² (which contains about 600 witness accounts.)
- [Crash at Corona: The U.S. Military Retrieval and Cover-Up of a UFO by Don Berliner and Stanton Friedman](#)¹⁴³
- [David Rudiak’s Website – “Roswell Proof.”](#)¹⁴⁴

Further, an excellent visual presentation of the story, in the form of a [TV Movie is Paul Davids’ “Roswell”](#)¹⁴⁵. From the research I have done, the facts presented in the movie are accurately portrayed, although some things were altered to fit neatly into a TV movie dramatization and narrative.

An outline of the case follows:

- On 8th July 1947, the Roswell Daily Record reported that the US Army had recovered pieces of a flying disk which had crashed on Mac Brazel’s ranch at Corona, near Roswell.
- Around the same time, UFO’s/Saucers had been seen in the area.
- The actual date of the crash may have been 2 or 3 weeks earlier.

- On 9th July 1947, the US Army changed its story, stating the debris recovered was only a weather balloon.
- Over time, many more witnesses came forward and spoke of there being
 - Two crash sites
 - Recovery of living and dead bodies
 - Recovery of unusual pieces of metal – such as the impervious, but light and flexible “memory metal” which returned to its original shape after being scrunched or folded up.
- Witnesses stated the debris and bodies were flown to Wright Field, Ohio (now Wright Patterson AFB).
- Defence Secretary James Forrestal was involved in the events and is said to have communicated with one or more of the aliens from the crashed craft.
- One of the aliens survived until 1954.



The US Army and USAF have since denied anything of importance happened, issuing a final report in 1997, stating that the recovered bodies were, in fact, dummies which had been used in testing exercises at the time.

It is said that this incident was the reason why the alleged MJ-12 or “Majestic 12” group was formed. It is also said that one or more bodies were autopsied (this being the basis/reason for the Alien Autopsy film).

Whilst there is, of course, contradiction and debate about many of the facts, it is clear to me that something extremely significant happened – and reading about the case and listening to the witnesses should convince anyone that official explanations are lies, designed to cover up something of enormous importance.

Walter G Haut



So, for the purposes of brevity, let us take one witness at his word. Below, I include his sworn affidavit, from 2002. Lt. Walter G. Haut was the Public Information Officer at the Roswell base. He made remarks publicly for quite a few years, mainly to confirm that he did indeed release the “crashed saucer” story, under the direction of the Base Commander, General Roger Ramey.

However, Haut implied several times that “he knew more.” It seems that this was the case, as he asked for his sworn affidavit only to be released after his death, which occurred in 2005. [Some critics have indicated problems with the affidavit, in that it wasn’t written out in one session, but was made up from statements Haut had made over the years and the name of the witness to the signature was not released](#)¹⁴⁶. Perhaps it took two years for this news to be released and for his family to agree, but [Haut’s affidavit was released in 2007, and is reproduced below](#)¹⁴⁷. (This revealed more of his knowledge – an earlier affidavit by Haut, released in 1993, was less detailed).

2002 SEALED AFFIDAVIT OF WALTER G. HAUT

DATE: *December 26, 2002*

WITNESS: *Chris Xxxxxx*

NOTARY: *Beverlee Morgan*

(1) My name is Walter G. Haut

(2) I was born on June 2, 1922

(3) My address is 1405 W. 7th Street, Roswell, NM 88203 (4) I am retired.

(5) In July, 1947, I was stationed at the Roswell Army Air Base in Roswell, New Mexico, serving as the base Public Information Officer. I had spent the 4th of July weekend (Saturday, the 5th, and Sunday, the 6th) at my private residence about 10 miles north of the base, which was located south of town.

(6) I was aware that someone had reported the remains of a downed vehicle by midmorning after my return to duty at the base on Monday, July 7. I was aware that Major Jesse A. Marcel, head of intelligence, was sent by the base commander, Col. William Blanchard, to investigate.

(7) By late in the afternoon that same day, I would learn that additional civilian reports came in regarding a second site just north of Roswell. I would spend the better part of the day attending to my regular duties hearing little if anything more.

(8) On Tuesday morning, July 8, I would attend the regularly scheduled staff meeting at 7:30 a.m. Besides Blanchard, Marcel; CIC [Counterintelligence Corp] Capt. Sheridan Cavitt; Col. James I. Hopkins, the operations officer; Lt. Col. Ulysses S. Nero, the supply officer; and from

Carswell AAF in Fort Worth, Texas, Blanchard's boss, Brig. Gen. Roger Ramey and his chief of staff, Col. Thomas J. Dubose were also in attendance. The main topic of discussion was reported by Marcel and Cavitt regarding an extensive debris field in Lincoln County approx. 75 miles NW of Roswell. A preliminary briefing was provided by Blanchard about the second site approx. 40 miles north of town. Samples of wreckage were passed around the table. It was unlike any material I had or have ever seen in my life. Pieces which resembled metal foil, paper thin yet extremely strong, and pieces with unusual markings along their length were handed from man to man, each voicing their opinion. No one was able to identify the crash debris.

(9) One of the main concerns discussed at the meeting was whether we should go public or not with the discovery. Gen. Ramey proposed a plan, which I believe originated from his bosses at the Pentagon. Attention needed to be diverted from the more important site north of town by acknowledging the other location. Too many civilians were already involved and the press already was informed. I was not completely informed how this would be accomplished.

(10) At approximately 9:30 a.m. Col. Blanchard phoned my office and dictated the press release of having in our possession a flying disc, coming from a ranch northwest of Roswell, and Marcel flying the material to higher headquarters. I was to deliver the news release to radio stations KGFL and KSWs, and newspapers the Daily Record and the Morning Dispatch.

(11) By the time the news release hit the wire services, my office was inundated with phone calls from around the world. Messages stacked up on my desk, and rather than deal with the media concern, Col Blanchard suggested that I go home and "hide out."

(12) Before leaving the base, Col. Blanchard took me personally to Building 84 [AKA Hangar P-3], a B-29 hangar located on the east side of the tarmac. Upon first approaching the building, I observed that it was under heavy guard both outside and inside. Once inside, I was permitted from a safe distance to first observe the object just recovered north of town. It was approx. 12 to 15 feet in length, not quite as wide, about 6 feet high, and more of an egg shape. Lighting was poor, but its surface did appear metallic. No windows, portholes, wings, tail section, or landing gear were visible.

(13) Also from a distance, I was able to see a couple of bodies under a canvas tarpaulin. Only the heads extended beyond the covering, and I was not able to make out any features. The heads did appear larger than normal and the contour of the canvas suggested the size of a 10-year-old child. At a later date in Blanchard's office, he would extend his arm about 4 feet above the floor to indicate the height.

(14) I was informed of a temporary morgue set up to accommodate the recovered bodies.

(15) I was informed that the wreckage was not "hot" (radioactive).

(16) Upon his return from Fort Worth, Major Marcel described to me taking pieces of the wreckage to Gen. Ramey's office and after returning from a map room, finding the remains of a weather balloon and radar kite substituted while he was out of the room. Marcel was very upset over this situation. We would not discuss it again.

(17) I would be allowed to make at least one visit to one of the recovery sites during the military clean-up. I would return to the base with some of the wreckage which I would display in my office.

(18) I was aware two separate teams would return to each site months later for periodic searches for any remaining evidence.

(19) I am convinced that what I personally observed was some type of craft and its crew from outer space.

(20) I have not been paid nor given anything of value to make this statement, and it is the truth, to the best of my recollection.

Signed: Walter G. Haut

December 26, 2002

Signature witnessed by:

Chris Xxxxxxx

June Crain



June Crain in the 1940s or 1950s



James Clarkson in the 2000s

In 2004, I became aware of another Roswell-related account which was investigated by a former Commissioned Police Officer, James Clarkson. The account came from June Crain who was a clerk/typist at Wright Field AFB. She worked there during three different periods – she stated she had a Top Secret/Q Clearance. When June Crain approached Clarkson in about 1993, following a lecture that Clarkson had given, she was reluctant to tell her story, but after the “Roswell: Case Closed” report came out in 1997, Crain decided to contact Clarkson again and tell him what she knew. (She knew the government report was untruthful and so decided to “blow the whistle.”) Crain died in 1998. [Clarkson published the transcript of an interview he conducted with June Crain on 27 June 1997¹⁴⁸](#) and I have included some of this below, edited for brevity and reading clarity (i.e. removing things like “OK” and “what did he say?”) [There are three Clarkson audio/radio interviews posted on his website¹⁴⁹](#), and in at least one of these, he plays portions of the tape-recorded interview with June Crain. Clarkson submitted FOIA requests to obtain records of Crain’s employment – the records confirmed what Crain told Clarkson.

This case is interesting because Crain was not in New Mexico, yet she states she handled some of the “morphing metal,” which an officer showed her. She also said that by 1952, there had been at least 3 other saucer crashes / retrievals, material from which was taken to Wright Patterson. (This, then, appears to tie in with what [Senator Barry Goldwater said in 1994 about a “room” at Wright Patterson AFB](#)¹⁵⁰.)

In the interview with Clarkson, Crain stated:

I was classified as a typist, and in those days, you were classed as a typist no matter what you did, because that was the way it went.

But I had extra intelligence and um also a great deal of curiosity and I was very meticulous about everything I did and I was a top speed secretary taking shorthand, ask them, and so I always got the plums with the jobs, I mean, when they had a job that they wanted to be perfect, they gave it to me. And I had top secret clearance... and then finally, they gave me ‘Q’ - what they called ‘Q’ clearance, which is what, at that time, was the highest clearance that you could have, because I was... doing very sensitive work.

June Crain reported that she had heard about bodies and wreckage being brought to the base. She described having a conversation with a Master Sergeant named “Clarence” (she couldn’t recall his surname) who was in charge of the plane on which the bodies were flown in to Wright Field/Patterson AFB.

Crain: ...he was in charge of that airplane... A transport, a military transport ... It came in from New Mexico. He said “what I brought in this morning... You read, it’s in here...” He said that he brought two little men in... He called them little green men. He described them as a greenish-blue. And they were four feet tall and they were dead.

Clarkson: So the color could have been because they were dead...?

Crain: Yeah, but you see it could have been anything.

Clarkson: We’re talking about non-humans?

Crain: Non-humans. Right...

Crain, when questioned, goes on to discuss handling the “memory metal:”

Clarkson: Now is that the same period of time that you mentioned before that someone actually showed you a piece of something?

Crain: Yes.... ‘51 ‘52...Okay ... Lieutenant Rose is the one that showed it to me, or Captain Wheeler, now, it could have been one or the other of those guys, cause they were both in personnel, personnel in ‘chutes. And uh, he walked in. And they always liked to rag me because they couldn’t figure me out. He threw it on my desk, and... well it was a piece about...about this big...and it was.

Clarkson: About half the size of a business card?

Crain: Yeah, about that size ... There, and it was bent like this. — And he says “June, you’re good. Tear that thing apart, break that up.” And I took it and I bent it and I twisted it and I laid it back down, and it went (sound) got right back to the same shape. I got back to my desk and he said, “cut it. Cut it. Try cutting it.” I got on my desk. I got my scissors out and I snipped at it.

And you know there was no way I could even cut that piece of metal. And it was as light as a feather. I had it in my hand and I couldn't... I would say that it didn't weigh as much as these two - it wasn't that heavy. It was so light but strong, and it was about the thickness would be about...

Clarkson: So, it's fairly thick but doesn't weigh anything?

Crain: But it had no weight at all, it was like a feather. And so strong - it was sort of a grayish, gun metal type of color, and you could see that on the inside that there was a different... that there was coating on the outside of it. Both sides were the same and the insides seemed to have a sort of a lead-colored... light lead-colored center to it.

Clarkson: What were the edges of this like? Were they even - or was it like part of something else?

Crain: It was even... all even and I said, "what is it?" He said, "it's a piece of a space ship." When I, you know got through with it and I couldn't do nothing with it, I said, "well, what is it?" And he says, "piece of a space ship." He said, "I just came back from New Mexico and I brought it back with me." See, he had no business having anything to do with it in the first place, but he...

Clarkson: So he was breaking security?

Crain: Yes, he was. Definitely...

Clarkson: Was it slightly in a "v" shape? Did I understand right...?

Crain: Sort of a curve. It was about... I don't know...and it was practically indestructible... I even took the edge of the scissors and laid it on...you know... Took the scissors like this, and I whacked it like this, and I couldn't even make a dent in it. Just nothing... Cause he said tear it up, so I tried everything I could to tear it up, and I couldn't tear it up. I couldn't make a dent in it; I couldn't make a mark on it.

Clarkson states in his transcript that

The experience of handling this odd metal made a strong impression on her and when I tried to get her to liken it to the characteristics of modern plastics and metals, she wouldn't budge from her opinion that it just wasn't like anything else.

Clarkson asked Crain about other alleged crashes and Crain replied "It was just, it was just a matter of fact. I mean they talked like everybody knew it, that they were crashing." Clarkson then stated:

June emphasized that the reality of UFO's, crashed and otherwise, was common knowledge amongst the scientists and engineers where she worked.

Clarkson asked Crain what she thought the "bottom line" was – relating to what she knew. She replied:

They've got UFO's and they're trying - they've apparently already discovered what the propulsion system is. And when they get that, their knowledge - their flight pattern will be... it'll be completely different, and all the aeronautical flights would be different.

However, Crain had no specific knowledge of any other special programmes related to this.

As with all similar accounts, we can ask ourselves “Would June Crain make all this up?” Were her co-workers making up stories to string her along? To me, the only sensible explanation is that she is telling the absolute truth, to the best of her memory.

More “Memory Metal” Witnesses

David Rudiak’s site contains a cross-referenced list of 30 people who either knew of or handled the memory metal¹⁵¹. One such witness was Frankie Rowe¹⁵¹, who was 12 years old in 1947. She is the daughter of Roswell fireman, Dan Dwyer, who allegedly was at the main saucer crash site. Rowe has given various interviews, and her description of the metal is very similar to the one given by June Crain.

He took his hand out of his pocket and he dropped what he had in his fist on the table. He said it was something he picked up out at the crash site. It looked like quicksilver when it was on the table, but you could wad it up. [It was] a little larger than . . . [his] hand. It had jagged edges” [and it was a dull grayish-silver color.] “You couldn’t feel it in your hand. It was so thin that it felt like holding a hair . . . It wasn’t anything you’d ever seen before. It flowed like quicksilver when you laid it on the table. [The firemen and the trooper] tried to tear it, cut it and burn it. It wadded up into nothing. The state cop said he’d gotten away with just this one small piece, and he said he didn’t know how long he’d be able to keep it, if the military found out.”

In 2017, Dr Jerry Kroth posted a YouTube video in which he relates his own account from 1965¹⁵² – when a pupil in his class showed him a piece of metal which seemed to be of a similar description:

I’m teaching the fifth grade and a little girl comes up to me with a piece of material about five inches square. And she says “My daddy says that I should show this to you.”

And I was . . . 25 years old... 24 years old and I thought it was aluminum foil and I say, “Thank you very much,” . . . “So well why don’t you crush it so I crushed it into a ball. She said, “Let it go, let it go...” and it just absolutely opened up. No creases – nothing. I said “Wow that’s not aluminum foil. What is that?”

She said, “Try to put a hole in it.” So I took a ballpoint pen - tried to... I mean this is paper thin... like a piece of stationery... silvery-gray, a little bit rubbery, not too much - a little bit. And I stabbed it and nothing happened. It just went like that and then it disappeared when you took the ballpoint pen away. She said, “Try to cut it.” I said, “Is that okay with your daddy?” and she said “Yes” and so I took up my scissors and I tried to cut it and it just bent. You could not cut it - I tried three different kinds of scissors, so I said, “Thank you” and I didn’t think anything more about it for probably 45 years. I thought her father probably worked at NASA and it was probably some kind of experimental material. And honestly, I had no interest in UFOs...

It seems that from research by people including Tony Bragalia¹⁵³, of Sarasota, Florida, that soon after the Roswell crash, “memory metal” research was instigated by the Battelle Institute¹⁵⁴. They didn’t necessarily get a real sample but were perhaps tasked with reproducing its properties.¹⁵⁵

To me, the “memory metal” accounts (and I’ve only touched on a few) strongly suggest there was physical evidence that the Roswell craft wasn’t a secret aircraft - nor was it something of human origin (And this is just a mere six pages of coverage...) [If you want more, you can download a document compiled by David Rudiak – which contains 60 pages of reports about Roswell-related debris](#)¹⁵⁶.

Other UFO Landings/Crashes

The Ted Philips “Collection”

[A researcher called Ted Philips](#)¹⁵⁷ stated he has collected evidence from about 5000 cases, dating back as far as 1790. Though a critique [of this collection by a researcher called Paul Fuller](#)¹⁵⁸ suggests that quite a few of these cases aren’t reliable, there are some very interesting ones that Philips has gathered evidence of.

[In a 2006 lecture given by Philips, he states that it was Dr J Allen Hynek who suggested that Philips start to collect physical trace evidence.](#)¹⁵⁹ Many of the cases date from the 1950s and, in the 2006 lecture referenced above, Philips states that trace landing evidence became less common after the late 1970s and that the reports he received or studied began to indicate that smaller and smaller objects were involved.

Also in his 2006 lecture, he discusses a case from [Delphos, Kansas which occurred at about 7:00pm on November 2, 1971.](#)¹⁶⁰ A 16 year-old Ron Johnson was tending sheep when he saw a mushroom-shaped object, about nine feet in diameter, with multi-coloured lights covering its surface. The object hovered about two feet off the ground and was only about 25 yards away from him. He watched it for “about 5 minutes.” Then it took off and Ron was temporarily blinded by a bright light from its base. Ron went to get his family, and when they returned, they *all* saw the object in the sky.

Philips investigated the case over several years and showed photographs of the ground where the object had hovered – which was severely affected by the object’s presence. He took measurements and soil samples and all of the evidence and testimony gathered supports the Johnson family’s account.

In the following short sections, I will cover some of the more prominent landing/crash cases that I have come across since 2003.

Aurora, Texas (1897)

This event was investigated extensively by [Jim Marrs and in 2002, he released a documentary, which has since been posted on YouTube](#)¹⁶¹. Accounts from a time before the age of “powered human flight” describe how an “airship” was seen flying over the Aurora area and it actually crashed into a wind mill or windless, hit the ground and exploded. Villagers from the area went to the crash site and found a small body, which was buried in the village cemetery on the same day. The main witness that Marrs interviewed (in 1973) was Charlie C Stevens – who was 83 at that time. From the documentary, we note:

As a young boy of about 7, he was with his father putting some cattle out to pasture on the morning of April the 19th 1897, when the pair saw a cigar-shaped object with a bright light pass overhead. The craft was very low and moved straight ahead toward Aurora which was about three miles to the north. The pair then heard what seemed to be an explosion and a fire lit up the northern sky for several minutes. Charlie stated that he wanted to go immediately and see what had happened, but his father said they had to finish the chores... Stevens said his father rode a horse into town the next day. On returning to the family farm he described a mass of torn metal and burned rubble. He made no mention of the pilot.

According to the contemporary accounts, the pilot was buried the same day as the crash, so when Stevens' father was in town, he would not have seen the pilot/the body. Stevens said that his father had no trouble talking about the crash during the years he was growing up. Stevens added he was almost twenty years old before he heard about the dead pilot.



Alleged Gravestone with Design¹⁶²

Other evidence from the site includes an alleged partial gravestone – apparently with a very indistinct design showing some type of saucer shape with portals.

There are quite a few people who said the whole thing was a hoax – including people who were alive at the time of the event and their descendants. Jim Marrs also attempted to find out more information about the grave, in the cemetery, but an earlier investigator of the event,

Bill Case, told Marrs that in the period of time where there was renewed interest in the case, the body had already been exhumed “by the government.” In the documentary, Marrs reported on further investigations of the alleged site of the crash in the 1990s or early 2000s:

One of the most convincing things of all are the strange beads of [formerly] molten aluminium that have been found at the crash site... Some of them embedded in nearby trees and rocks. This indicates that there was a tremendous explosion, at some point at that location, and yet Brawley Oates, who I interviewed back in the 70s, said he bought the place before World War two in the late 30s. I believe that there had been no big explosion there, so whatever happened there happened before the 1930s. Also the metal content and makeup of this aluminium, while it was aluminium, is not the same as modern aluminium... Aluminium [extraction] had only been developed in the past maybe ten years prior to 1897¹⁶³ [when the alleged crash happened] and it was so rare that it actually cost more than gold. So, the idea that somebody would have faked something using aluminium, at that time, is nearly impossible.

Aztec Crash, New Mexico, 25 March 1948

Happening the year after Roswell, in Hart Canyon, near Aztec, New Mexico, this story was regarded as a hoax – supposedly perpetrated on Frank Scully in 1949 – by an Oil Prospector, Silas Newton. Scully wrote about the event in his excellent 1950 book “Behind the Flying Saucers.”¹⁶⁴ Again, sceptics take

refuge in the idea that the story was part of a scam being run by Silas Newton and one of his colleagues Leo GeBauer. They had allegedly used a gadget that could detect minerals and oil in an attempt to defraud investors.

It wasn't until the mid-1980s that a researcher called [Scott Ramsey and his \(now\) wife, Suzanne, began to investigate the case more thoroughly.](#)¹⁶⁵ The accounts they reviewed and uncovered indicated that a 100-foot wide craft had got into trouble and made a forced landing in the early hours of 25 March 1948. The craft was witnessed by several people – both while in the air and on the ground. An oilfield worker, Doug Noland, actually witnessed the craft close up. According to Noland, his co-worker, Bill Ferguson, went right up the craft and, poking a pole (that he obtained from a truck at the site) through a hole somewhere, caused the opening of a ramp! Following this, several people, who had also found their way to the site, entered the craft and witnessed as many as 16 dead bodies inside. These bodies appeared to be human but were badly charred.

Research by the Ramseys strongly suggests that about 200 people were involved in the recovery operation, which was highly compartmentalised and lasted about 2 weeks. One witness, Fred Reed, reported he was involved with “sanitising” the site – by recovering small pieces of debris and also burying some things under 18 inches of soil or dirt. This witness also stated that trees were replanted, where some had been broken by the impact of the saucer that crash -landed.

Another witness, whose name was withheld, stated to the Ramseys that he was involved with falsifying the work records of personnel involved in the recovery operation so that the military, if asked, could state those people weren't even in that part of the country at the time of these events.

The Ramseys stated that they started their investigation by trying to verify some of the claims made by Scully's witness “Dr G,” which related to a radar installation that Dr G had knowledge of. After much research, they were able to find and visit an abandoned and dilapidated site in Southern Colorado which fitted the description of said radar facility. Some of the difficulties they encountered while trying to find the site were caused by the fact that the site was *not* originally owned or run by the US Airforce, nor the US Army. It was, in fact, run by the Atomic Energy Commission! This was because the radar facility, essentially, had formed part of the Manhattan Project – in that they wanted a means of detecting any foreign aircraft that might want to fly over the area surrounding Los Alamos National Laboratories (to the south), where the Atomic Bomb was being developed. Hence, the radar facility itself was top secret at the time it was built.

In their book, [“The Aztec Incident,”](#)¹⁶⁵ the Ramseys meticulously analyse and assemble the evidence that the Saucer crash story is true. Though they don't make any claims beyond what the evidence shows, they do find, for example, evidence that a special road was built (not marked on the map) by the military, solely to allow them to recover the large craft. There is even a concrete “slab” or pillar in the ground at the site which was, according to some accounts they

uncovered, put in place to allow a crane to be effectively used to lift up the saucer. Without the pillar, the crane sank into the soft, sandy soil too much.

The “Aztec Incident” book also includes some of the writings of Silas Newton who, it appears, was actually the victim of a deliberate smear campaign, due to him discussing the saucer crash story with Scully and others. Silas Newton was essentially “stalked” by a character called J.P. Cahn, following Newton’s leaking of the Saucer story to Scully. The “Aztec” book also contains quite a detailed account of J.P. Cahn’s efforts to discredit Silas Newton, Scully and the crashed saucer story. Cahn’s efforts were largely successful and the Aztec story was ignored, almost completely, for over 35 years. (As is mentioned in the chapter about Travis Walton, in considering the attitude and activities of J.P. Cahn documented by the Ramseys, we can liken him to Philip J Klass. This is to say that some people really do seem to have a pathological desire to discredit cases with solid evidence – even resorting to offering bribes to encourage people to lie about what they know.)

Another debunker the Ramseys “sparred” with was Karl Pflock, who repeated the stories about Silas Newton being a fraud and the impossibility of such an event happening due to the scale of the recovery that would have been seen by locals and – according to Pflock – was never actually seen by anyone. As the Ramseys point out, debunkers like Pflock had never visited the site in Aztec, nor had they spoken to witnesses of the case, yet some people seem to think that the statements of sceptics who have neither done “on-site” investigation” nor spoken to witnesses, establish the truth of the matter.

The truth about the Aztec Crash which emerges from the Ramseys’ research is that scientists who were working with Silas Newton (a wealthy and well-respected businessman, who had no need to run a scam to make money) had access to a Magnetic Anomaly Detection Device. This device could be used for detecting oil and water underground, yes, but it could also be used for detecting submarines underwater. Hence, the military had an interest in what people were doing with this sort of technology, regardless of any relationship it might have had to a crash-landed saucer.

A small footnote here is that, although the Ramsey’s research really is excellent, they mention at least twice how the work on rocketry programmes in the later 1940s in New Mexico lead to “a man being put on the moon.” This, I know, is untrue (please read the relevant chapters in [“Finding the Secret Space Programme.”](#)⁴²) Also, in one chapter passing mention is made of Dulcé and the alleged base there.

Our first night was in Dulcé (January 8, 1999), where Archuleta peak or mesa has become the center for some of the worst fictional UFO rumors ever created about underground alien bases under the old mountain where little gray men cook body parts and plot the end of humanity.

Whilst the tone is rather scornful, we will see in a later chapter that this summary is also probably rather more accurate than some people in the UFO/ET research community would like to accept...

Socorro, New Mexico, 24 April 1964

This also became a well-known case and was thoroughly investigated at the time, perhaps because the main witness, Lonnie Zamora, was a well-respected police officer in the area. [Zamora witnessed the landing of an egg-shaped object, about the same size as an average car, followed by the appearance of 2 figures.](#)¹⁶⁶ There was again, trace evidence, such as depressions in the ground and burned foliage on nearby bushes.

There is also another story of a crash at Socorro, in August 1947 – witnessed by two young boys, but the details of this event seem to be extremely sketchy.

Kecksburg, Pennsylvania, 9 December 1965



Kecksburg's Memorial of the event, which was at one time displayed near the Fire Dept.¹⁶⁹

In this incident, an object was observed flying erratically over the area and it then made a forced landing in some woods near the town. One of the main investigators of the case was Stan Gordon. He has made a comprehensive DVD about the case – [“Kecksburg: The Untold Story.”](#)¹⁶⁷ [The incident was also the subject of an excellent documentary made by the Sci-Fi Channel and aired in the USA in October 2003.](#)¹⁶⁸ Below, I heavily use portions of Gordon's excellent summary of the case.

On December 9, 1965 an event occurred about 40 miles from Pittsburgh in a rural area of western Pennsylvania, that even now remains controversial for some, and mysterious to others.

At the time many people saw a brilliant object moving across the sky. The news media focused on a young boy, who while playing outside, said he saw an object fall from the sky into some nearby woods.

Many people say that the military, including members of the Army and Air Force, began to arrive in the area around the village of Kecksburg within a few hours after the reported landing. During the evening, reporters from numerous media sources went to Kecksburg to investigate the event. The area around the alleged impact site was cordoned off, and a search for the object was conducted in the woods. Hundreds of spectators looked on from a narrow country road which circled around the area, unaware that the object appears to have fallen on the opposite side of the woods.

As time passed that evening, many people left disappointed that they couldn't see the object. A few curious folks tried to sneak down into the woods, and later told me that they were tuned back by the military. Late that night, others say they observed a military flatbed tractor-trailer truck, carrying a large tarpaulin covered object, leaving the area at a high rate of speed. Reporters are among the many witnesses who verify that they saw military personnel in the Kecksburg area that night.

Officially, no object was found in the woods by searchers. It was suggested that the most likely explanation was that the brilliant object in the sky was a meteor. But word that something was removed from the site by the military that night, quickly circulated around the county.

Though many important witnesses have passed away, what we now know is that there are individuals who say that they went down into the woods that December day in 1965, before the military arrived, and came upon a large metallic acorn shaped object partially buried in the ground.

The late John Murphy was the new director of WHJB radio in Greensburg at the time, and is believed to have been the first reporter on the scene. His former wife says that she was in radio contact with him from the site that day, and that he told her that he went down into the woods and saw the object.

The device was large enough for a man to stand inside of it. The object was a bronze-gold color, and appeared to be one solid piece of metal, displaying no rivets or seams. At the back of the acorn shape was what witness Jim Romansky calls the bumper area and also some unusual markings that Romansky says looked similar to ancient Egyptian hieroglyphics. Romansky who has been a machinist for many years, says the object itself, looked as though it had been made from liquid metal and poured into a big mold. Since the object was impacted in the ground, the bottom portion was not visible, but what could be seen appeared well intact.

Gordon also states:

Before Unsolved Mysteries broadcast their story about Kecksburg in 1990, I was contacted by a former Air Force security policeman who told me that he was among the unit that guarded the object from PA, when it arrived in the early morning hours of December 10, 1965 at Lockbourne Air Force near Columbus, Ohio. He remembers extreme security measures at the time and says that the object was only at the base for a short time, and then continued on to Wright-Patterson Air Force base near Dayton, Ohio.

Gordon refers readers to [Kevin Randle's book "A History of UFO Crashes."](#)¹⁷⁰

Sceptics have tried to explain away the case as a faulty/off course Soviet Venus probe called Kosmos 96, which re-entered the atmosphere over Canada on the same date, but at about 3:18 A.M! (Yes, the wrong place and the wrong time...but why should that matter?) Other explanations have included an errant Thor rocket. However, as with all these cases, debunkers simply latch on to one or two pieces of evidence, offer a prosaic explanation for those pieces of evidence and then they ignore all the rest of the evidence and either state or assume witnesses are idiots, liars or bad/mistaken observers.

Shag Harbour, Nova Scotia, Canada, 4 Oct 1967

On the night of 4 Oct 1967, several orange lights were sighted, over the sea near the small fishing village Shag Harbour. On the same night, a 12-year-old Chris Styles also saw an orange sphere moving along the harbour in Dartmouth Nova Scotia. The next day, his Grandfather called him to report he'd seen similar lights at Shag Harbour and that one of them had gone into



the water. In 1993, Styles saw a documentary about the Roswell case and this encouraged him to re-investigate the Shag Harbour case, of which he later became one of the main investigators. [A documentary about the incident was released in year 2000 and several key witnesses were interviewed.](#)¹⁷¹

Below, I have heavily quoted from a summary on the “Shag Harbour Incident” website.¹⁷²

Having seen the lights, witnesses thought they were watching a plane crash, and quickly reported as much to the Barrington Passage Royal Canadian Mounted Police. RCMP Constable Ron Pound had already seen the lights as he drove down Highway 3 en-route to Shag Harbour. Pound felt that he was seeing 4 lights, all attached to one flying craft which he estimated to be 60 feet long. Approaching the shore, Pound clearly saw a yellow light slowly moving on the water, leaving a yellowish foam in its wake. It slowly either moved away until it was too distant to be seen or had sunk deeper into the sea.

At least two fishing boats had already seen the lights too and made their way across the water to them, in order to try and rescue any people that may have gone down with the (presumed) aircraft. However, all they found when they got there was the yellow foam from the object’s wake – which was about ½ mile long. They knew this was not tidal foam. (It dispersed over the next few hours.)

The RCMP contacted the Coast Guard to start a search and the following day, the Rescue Coordination Centre filed a report with Canadian Forces Headquarters in Ottawa, stating that something “of unknown origin” had hit the water.

Divers from HMCS Granby were deployed to the location of the crash, where they searched the bottom of the ocean for several days, but no results were released.

Again, it was in 1993 that Chris Styles and MUFON investigator Doug Ledger began to re-investigate the case by identifying and interviewing witnesses. [According to Styles and Ledger](#)¹⁷³, it was found that the object that entered the waters of Shag Harbour had soon left the area, traveling underwater for about 25 miles to a place called Government Point, at the mouth of Shelburne Harbour, which was near a top-secret NATO submarine detection base. The object was detected with hydrophones and naval vessels were positioned over it. After a couple of days of military observation by navy divers and sensors, the military made plans for a recovery operation. That’s when a second USO (unidentified submerged object) joined the first. “Off the record” military

witnesses indicate that the second craft had arrived to render aid to the original USO.

The Navy had assembled a flotilla of ships, which monitored the two USOs for about a week! Then, the flotilla was moved away, to investigate a Russian submarine which had by then entered Canadian waters nearby. The two underwater craft made their move – south, to the Gulf of Maine, putting distance between themselves and the chasing navy ships. Incredibly, they later surfaced, and shot away into the skies.

Berwyn Mountain, Wales, UK, 23rd January 1974

This case has been investigated extensively by [UK researcher Scott Fulton](#)¹⁷⁴, who, in turn, followed up earlier investigations by [Margaret Fry](#)¹⁷⁵.

In the evening of 23rd January 1974, a number of people in Llandrillo and the surrounding area reported that there was an explosion and the ground shook, even causing glasses to fall off shelves in a pub. Shortly after the explosion, some witnesses reported seeing a large spherical light fly over the area, towards the mountain. Many calls were made to the local Gwynedd Police to report the incident ([as was revealed when documents were released in 2008](#)¹⁷⁶). People also saw a blaze of light on the mountainside just after the explosion. At about the same time, Pat Evans, the District Nurse, had heard about the incident and she initially suspected a plane crash had occurred. [In an interview \(date unknown, but probably during the 1990s or early 2000s\)](#),¹⁷⁷ she stated:

Pat Evans: I called my daughters and we got into the car and we made our way up to the mountain. We drove a fair way along the mountain road and to our left, we could see a huge orange ball sitting on the mountain, glowing.

Diane Evans: We started looking [for] what we thought was going to be an aircraft on fire. We'd envisaged, "Oh God you know there might be bodies" – if it was an aeroplane crash. We weren't too happy at the prospect, but we were quite surprised to see this big reddish orange ball, just sitting there. There were no flames and it was so uniform. The shape – the round, spherical shape of it made us realise we weren't looking at an aircraft. There were no flames jumping – it was pulsating, this red/orange object that we saw.

Pat: ...and we could see little lights like fairy lights coming towards the object, in a zig-zag pattern and we assumed at that time there was someone possibly going to see "what was what."

Diane: With hindsight, we realised the search party couldn't have got there and located it in the time it had taken us to go from the village up to the mountain. No one could have organised themselves to get to the object that we saw.

In 2011, [UK researcher, engineer and film-maker Richard D Hall](#) released a [film](#)¹⁷⁸, centred around Scott Felton's research and this included new interviews – some with witnesses who had never given their account to any previous researcher or in any film. The film documents facts of the case – and some of the efforts undertaken to cover up and muddle up those facts. This

“muddle-up” seemed to involve circulating a false story about alien bodies being recovered from the site.

Richard D Hall visited the site of the incident several times, over a period of about a year (or more). He confirmed, having spoken to witnesses, that around the time of the events, there was a strong military presence in the area and also there seemed to be police officers there who were not local to the area. In the last segment of his film, he states:

1. *On the evening of the 23rd of January 1974 an active army unit was on standby somewhere within 20 miles east of Llandrillo, probably stationed at Llangollen.*
2. *At 8:38 p.m. a large object impacted on the side of the Cadir Berwyn mountain and the Army was immediately dispatched to seal off the area and possibly recover debris. Locals were kept away from the impact site by road blocks.*
3. *Shortly after the impact, a red-orange glowing/pulsating sphere approximately 15 meters in diameter was witnessed by at least seven people, seemingly resting on the side of the mountain (Due to the terrain, neither the impact site, nor the object was visible from the nearest town Llandrillo.)*
4. *The object remained on the mountain for 1 hour and 40 minutes before taking off and disappearing.*
5. *While the object was still on the mountain, the army unit approached it, carrying torch lights.*
6. *We don't know if the orange sphere was the impacting object or whether the sphere came down in response to another impacting object*

This then begs the question did the military deliberately shoot something down?

It seems from the witness accounts that the glowing sphere made a controlled landing. Did the Army know *when and where* it was going land? Given the nature of the object that was witnessed, consider how profound it would be to find *affirmative* answers to these questions. Then consider if that would be a sufficient reason to organise a decades-long cover up.

Rendlesham Forest, Suffolk, UK – December 1980

This incident happened on 26th and 27th December 1980 in Rendlesham Forest, Suffolk, UK. The forest lies between Woodbridge and Bentwaters bases which, at the time, were “leased” to the USAF.

Airmen Edward Cabansag, John Burroughs and Bud Stefens had reported seeing unusual lights over the forest, just near the base. Sgt. Jim Penniston then drove “off base,” with them, through the East Gate and into the forest. They approached the object and then stopped the vehicle, some distance from it. Penniston left the other two men in the vehicle and he approached the object on foot. [The following is quoted from a “The Rendlesham Incident” Website¹⁷⁹:](#)

When Penniston got to a distance of 50 meters he could make out a metallic type object, some kind of craft, but unlike any he had ever seen in his seven years in the Air Force. As he moved closer, he discovered that the air seemed to be charged with static electricity, causing his hair to stand on end. As he closed to within 20 meters of the object, he noticed that the animals had scattered and the area was now completely quiet. As he got closer still, he could see the object in more detail. He described seeing a shiny black, triangular shaped craft, three meters in width and two high. The surface was smooth - almost glass like. He later said it was about the size of a tank. White light was emanating from both the top and bottom of the craft. Red and blue lights flashed alternately on either side.

Penniston then took out a camera and began photographing the object. He shot the entire roll and then moved closer so he could circle around the back of it. He was amazed to see no visible means of propulsion, nor was there any obvious signs of conventional manufacture: no seams or rivets. By now, and in complete awe of what this object might be, he courageously placed his hands on its surface, which he said felt warm despite the freezing night of an English winter. Sliding his hand over the smooth exterior he discovered a series of raised symbols etched onto its left-hand side. The symbols, which he later drew, were about three inches high and covered an area of about three feet in diameter. When Sgt. Penniston put his hand on the etched symbols, which felt like sandpaper compared to the rest of the smooth molded surface, everything became a brilliant bright white. He could neither see nor hear. He was alone in a brilliant bright white light. This occurred for an undetermined amount of time then his sight returned. He was standing next to the craft, facing the pictorial glyphs. The craft started to turn a vivid bright white color. So bright in fact, Sgt. Penniston thought it was going to explode. He took a defensive position nearby as the craft was engulfed in the light. The craft then lifted off approximately four feet from the ground, maneuvered between the trees, ascended to tree top level and disappeared in the blink of an eye.

Following this amazing encounter, Penniston was granted six days of leave. It affected him deeply.

Amazingly, the object was sighted again on Dec 27th and, during a party, Deputy Base Commander, Col Charles Halt – who had been away from the base on the previous night - was told “It’s back.” (He had already spoken to Cabansag about the incident.) He then went into the forest himself, with the intention of proving it was all a misconception of some kind. Again, quoting from “[The Rendlesham Incident](#)” Website¹⁷⁹:

With a team of men Halt entered the forest he discovered numerous personnel and vehicles already there. Men ran all over the place as both vehicles and lighting equipment were malfunctioning. He then took his patrol to the original landing site and shortly after this spotted a glowing red object moving through the forest. During much of the entire time Halt had activated a mini tape recorder so an audio record could be made. This tape was later released to the public. It makes for riveting listening. On it you can hear Halt and his men getting closer to the UFO. “There is no doubt about it, there is some type of strange flashing red light ahead.” He states on the tape. Then



A mock-up/model based on Penniston's sketch, was positioned in Rendlesham forest in 2014.
(It has been dubbed "the Lemon Squeezer" by some...)

his voice gets extremely excited as he says - "It's coming this way, it's definitely coming this way. Pieces of it are shooting off. There is no doubt about it this is weird." Halt described the object as circular, like a large eye winking at him. Later in the tape he states "He's heading towards us now. Now we are observing what appears to be a beam coming down to the ground. This is unreal."

He was later to describe the same thing that he wrote in a memo, dated 13 Jan 1981.

The beams of light from the craft were directed at the "WSA" – the Weapons Storage Area. In the height of the US-UK/Soviet "Cold War," this part of the event was, of course, highly significant.

Other evidence from this case includes:

- Penniston's notebook
- Radiation readings
- Radar traces from other sites
- Landing site
- Plaster casts
- Tree damage



Col Charles (Chuck) Halt (left) and Sgt Jim Penniston

Also, officers from Suffolk (civilian) Police were involved in certain related events and sightings.¹⁸⁰

There have been other claims made about a third landing site, mainly by Larry Warren, but there are some significant problems with parts of his story (and stories he has told since 1981). It is Warren's statements which introduced the

idea of “aliens” or “entities” being sighted as part of one of the landing events and it appears this has been muddled together with statements made by another witness, Adrian Bustinza. Journalist Georgina Bruni (who died in 2007) wrote a comprehensive and important book on the incident called “You Can’t Tell the People,” which was published in 2001. She interviewed all of the main witnesses and investigated the case quite thoroughly. Her book is recommended reading. [Also, a more recent book has been co-authored by Burroughs and Penniston.](#)¹⁸¹ (Sadly, they chose to involve Nick Pope, too. Nick Pope is discussed in a later chapter.)

Conclusions

I have tried to give a concise overview of a few of the major cases from the last 70+ years. These have been written up comprehensively elsewhere, so please consult the referenced sources for further details.

For me, the Roswell case seems to have an enormous number of both military and civilian witnesses that have recorded their testimony and experiences. They all seem to tell, essentially, the same story. That story, and the story of other cases has been covered up using similar or identical methods to what I and others have described elsewhere.

The Rendlesham Case is rather different to the others I covered in this chapter, as it involved repeated visits of “something” and, to my way of looking at it now, seems less likely to have involved extraterrestrial craft. It sounds a bit more like some advanced military craft that was involved, although Halt’s account of the beams and the craft’s behaviour (breaking into pieces) is rather extraordinary for secret, terrestrial technology. The craft that Penniston encountered seems to have some similarities to the craft that Mark McCandlish and Michael Schrott called “The Dart” – which I covered in chapter 22 of [“Finding the Secret Space Programme.”](#)⁴² Was it an unmanned/drone version that Penniston saw? The “Dart” was said to have three spheres at each corner of its triangular fuselage – and there were three similarly placed/sized depressions in the ground at the landing site in Rendlesham Forest.

If you decide to study each of the cases above in depth, you will find a great deal of corroborating evidence among witnesses in each case. You will probably also find some “story-tellers” and even some fake witnesses, and some folks seemingly getting involved “just because they want attention.” However, you should also realise that at the core of these cases, lies a basic truth. Intelligently controlled objects of unknown or undisclosed origin have, indeed, crashed on or been brought down to earth. Others have made controlled landings. Whether they have crashed or soft-landed, they have left behind traces. In fact, claims or statements by sceptics and debunkers about there being “little or no physical evidence of landings” are false and misleading.

The most powerful evidence, by all accounts, is in the hands of the most powerful groups in the world – the military and intelligence agencies of the

“superpowers.” Whether they collude internationally with one another regarding keeping this evidence, literally underground, is not at all clear. What is clear is that they are very good at burying it. It appears that burglary, violence, threats and even, perhaps, murder are all strategies that have been used to prevent you, dear reader, from learning the full extent of what is known about the evidence of the crashes, the landings, the craft and their occupants.

6. Some Video Evidence and Some Powerful Witness Testimony

Video Evidence

In this section I will review a small selection of video evidence. Clearly, you will need to use the embedded links – or your favourite search engine – to view the videos concerned – which you should find online.

Multiple Craft on NASA Space Shuttle Videos

Following my discovery of the Disclosure Project and the powerful evidence contained therein, one of the next “stops on my journey” was in relation to the work of [Martyn Stubbs](#)¹⁸², which I first learned about in a video called “The Secret NASA Transmissions - The Smoking Gun.” Stubbs worked as a Cable TV manager in Vancouver, Canada and had access to his “own” satellite dish at the station and he also had access to a bank of recording equipment and he took it upon himself to record every minute of every shuttle mission, over several years. He therefore recorded over 2,500 hours of video footage from numerous NASA Space Shuttle Missions and he studied the footage closely. Stubbs was interviewed in 2000 for Graham Birdsall’s British UFO magazine. He described that, in the videos, he had discovered a separate phenomenon to what appear to be intelligently controlled craft. One of the other phenomena he discovered was something that was very short-lived – a streak of light (close to the camera) lasting only about 1/60 of a second. (One immediately thinks it could have been an effect of cosmic rays, so I personally was far less interested in his discussion of this than I was in the craft shown in the footage he captured.)



Stubbs writes on his YouTube channel (as of Oct 2018):

I am Martyn Stubbs AKA secretnasaman. These are videos that I downloaded from NASA shuttle cameras, live during the 1990s. All the UFO clips are from my NASA UFO Archives, containing all video downloaded from mission STS-48 on, where I “discovered” all the NASA UFO video, including the STS-75 “Tether Incident” footage.

My discoveries of NASA UFOs, now dominates YouTube because they have been shared, copied & re posted, tens of thousands of times worldwide & they have generated mega millions of hits! THIS WAS MY GOAL. To get as many people to view this genuine, unimpeachable, unedited NASA video as possible! THANK YOU everyone, for making this happen.

As Stubbs stated above, one of the most amazing pieces of video he captured was in Space Shuttle mission STS-75 during the so-called “[Space Tether Experiment](#)¹⁸³” on 26 Feb 1996. A large, spherical satellite was deployed from the US space shuttle at the end of a conducting cable (tether) 20 km (12.5 miles) long. This was to test if the satellite and cable could be used to produce

electric power – like a dynamo – utilising the earth’s magnetic field to generate a current to run equipment aboard the space shuttle. They were also interested in seeing whether solar cells could generate a current that could be fed back into a tether to change the orbit of the satellite.

This incident was filmed by the shuttle crew. The Tether experiment did not go to plan and the cable broke, apparently due to an overload of electrical current. However, the cable and the satellite were then surrounded by a collection of strange particle and orb like objects – some of which pulsed. NASA has stated these were simply ice crystals, but a repeated examination of the footage seems to rule that explanation out.



David Sereda completed an extensive analysis of the sequence in 1999 and published this in a video called “Evidence: The Case for NASA UFOs”¹⁸⁴ in which he seeks the opinion of Dr Edgar Mitchell (see chapter 27 of “Finding the Secret Space Programme”⁴²) on the “Tether” video. Mitchell claims he can’t see anything of interest!

I recommend viewing the Sereda video, as the stills shown here don’t really look significant.

The 1996 STS-75 “Tether” incident is somewhat reminiscent of the 1991 STS-48 incident, where it appears something was fired at an object travelling towards the earth and it then abruptly changes

direction, as discussed in chapter 26 of my “Finding the Secret Space Programme”⁴² book.

Another incredible sequence that Stubbs recorded was from the STS-80 mission¹⁸⁵ (which some again claim shows ice crystals – yes, really!) It was recorded on 1st December 1996 and shows two circular, luminous objects



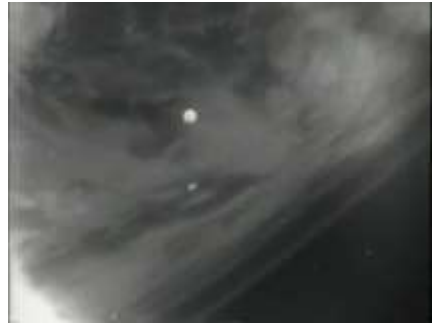

moving beneath the shuttle, apparently inside clouds in the atmosphere, for at least part of the sequence.

The sequence also shows flashes of light in the clouds – which must be lightning flashes from ongoing storms. At one point, one of the objects appears to “power up,” increasing in brightness quite significantly. Again, one needs to view the video itself here, as the stills, shown here, tend to look like meaningless fuzzy blobs.



At about 4:42 into the sequence referenced above, this object is seen to travel across the field of view in less than 2 seconds. A micro-meteoroid? Possibly, but then when we consider the other objects seen below, and their behaviour, we can consider other possibilities, perhaps.. In viewing the Stubbs footage, one can observe many similar streaks.

Other footage shows objects travelling at extremely high speed in the earth’s atmosphere and also objects which change direction suddenly (these are highlighted and discussed in David Sereda’s video).

NASA will not really discuss what is shown in these videos in an appropriate manner and personally, I have never seen a satisfactory explanation for what they show. My explanation would therefore be “some of these videos show intelligently-controlled craft manoeuvring in the upper atmosphere, possibly monitoring and/or interacting with thunderstorms.” To my knowledge, our “Disclosure friend,” Dr Steven Greer has never acknowledged or discussed what is shown in this footage – even though (or perhaps because) he has stated his Uncle worked for NASA on the Lunar Module.

Only a few other researchers (such as David Sereda) seem to have studied closely and then commented on this powerful evidence. As it is video evidence that comes via NASA, it should be treated much more seriously – not only by NASA themselves, but by any researchers interested in the UFO subject. Having reviewed the collection of evidence myself, I can only

conclude that we are seeing intelligently controlled craft operating in the earth's atmosphere and in low earth orbit.

Other footage shows objects travelling at extremely high speed in the earth's atmosphere and also objects which change direction suddenly.

NASA will not really discuss what is shown in these videos in an appropriate manner and personally, I have never seen a satisfactory explanation for what they show. My explanation would therefore be "some of these videos show intelligently-controlled craft manoeuvring in the upper atmosphere, possibly monitoring and/or interacting with thunderstorms."

Phoenix Lights, Arizona, 1997

The Phoenix Lights case is a good example which refutes the statement by some "that large UFOs are never seen over large cities." As we briefly mentioned in chapter 3, during the apparition of Comet Hale Bopp on 14th March 1997, perhaps as many as 10,000 people, including state governor Fyfe Symington, witnessed what appeared to be an enormous craft slowly cruising over the city. A witness called Mike Fortson of Chandler, described the craft as "profoundly massive" – a description that would be echoed by Stacey Roads who sighted the same craft gliding silently over Tucson. Both witnesses were interviewed for [the 2003 documentary "Out of the Blue,"](#)¹⁸⁶ as was Fyfe Symington, who was quickly employed in a perception management stunt following his announcement of a full investigation being carried out into the incident.



Phoenix Lights (most likely a still from Dr Lynn Kitei's video)

Another witness, [Dr Lynn Kitei](#)¹⁸⁷ also recorded the lights (explained by the US military as "flares") and, years after the event, made a documentary about the case.

The Phoenix Lights case is perhaps a little more complex than it might first appear, as more than one object was seen – and this happened over a period

of several hours. Orbs were also seen and seemed to have been chased by aircraft launched from Luke Airforce Base.

Like most cases, there has been no open, public investigation into the events so all we can do is piece together a timeline of events from the various witnesses. At the end of this process though, I don't think it is safe to conclude that this was either a display of classified military technology or something truly alien. In considering the scale of the object that was seen by hundreds of thousands of people, however, it stretches credulity that it was something developed, say, in Area 51. The wall of silence that is built around these sorts of incidents is still, even decades after the event, a seemingly impenetrable barrier to people like me.

Stephenville Lights Case, Jan 2007

This was another sighting which seemed quite similar to the 1997 Phoenix Lights case, although it took place over the small town of Stephenville in Texas.

[A page on Scott Waring's website](#)¹⁸⁸ has some details about the case, including a story entitled "Dozens Report UFO Over Texas Town" that was written by Angela K. Brown, an Associated Press Writer and published on January 15, 2008

(AP) In this farming community where nightfall usually brings clear, starry skies, residents are abuzz over reported sightings of what many believe is a UFO.

Several dozen people - including a pilot, county constable and business owners - insist they have seen a large silent object with bright lights flying low and fast. Some reported seeing fighter jets chasing it.

"People wonder what in the world it is because this is the Bible Belt, and everyone is afraid it's the end of times," said Steve Allen, a freight company owner and pilot who said the object he saw last week was a mile long and half a mile wide. "It was positively, absolutely nothing from these parts."

While federal officials insist there's a logical explanation, locals swear that it was larger, quieter, faster and lower to the ground than an airplane. They also said the object's lights changed configuration, unlike those of a plane. People in several towns who reported seeing it over several weeks have offered similar descriptions of the object.

Machinist Ricky Sorrells said friends made fun of him when he told them he saw a flat, metallic object hovering about 300 feet over a pasture behind his Dublin home. But he decided to come forward after reading similar accounts in the Stephenville Empire-Tribune.

"You hear about big bass or big buck in the area, but this is a different deal," Sorrells said. "It feels good to hear that other people saw something, because that means I'm not crazy."

Sorrells said he's seen the object several times. He said he watched it through his rifle's telescopic lens and described it as very large and without seams, nuts or bolts.

Debunkers and sceptics simply write off the sightings as being of an ordinary aircraft, but again that doesn't really explain what the witnesses saw, and we end up back in the same position as with the Phoenix Lights sightings, 10 years earlier.

I am sure that some readers, at this point, will be asking themselves "Why hasn't he included the [insert name] case or the [insert another name] case?" A fair question! I suppose the point I am trying to make is that we are never given suitable answers through official channels and, after a few months, interest in a given case fades away and, apart from witnesses who have accepted that what they have seen is part of "a new reality," the status quo in society seems to be largely unchanging.

Anthony Woods - "The Journey"

In 2003, a video made by the late and well-respected UK UFO researcher Graham Birdsall (and others) was released. Called "[The Journey](#),"¹⁸⁹ it documented the very unusual case of Anthony Woods who lived in Portsmouth, UK. (You can currently view the video on YouTube using the link above.) Woods had his first UFO sighting in 1972, when he was 8 years old. It was a bright, clear November morning, when he and some friends were playing in the street. He looked up to the sky and saw a "round silver metallic object with portholes around the middle." The sighting only lasted a few seconds. Woods said that after this, he had recurring dreams about UFOs and then it was in his mid-20s that he had another experience when camping in the New Forest in the 1990s – when he saw "two dancing lights up in the sky" (his description is similar to the sighting I had in the mid-70s). In May 1996, Woods described he was letting the dog out at about 10:30pm one evening. The dog hesitated in going out and he looked up and to the left - seeing a silent disc-shaped craft, about 30-40 feet in diameter, glide silently over houses near his home, about 50 feet above the roof tiles. He then watched the disk travel into the distance, until it was just a "small ball of light." He was shocked and amazed by what he saw and told his wife and his family.

The following evening, he opened the door about 9pm and he saw a bright light very high in the sky – but it was stationery. He thought it must be quite big – and then it began to move and he watched it move slowly into the distance.

From approximately 1999, he began to record as many sightings as he could, using a camcorder. Over the next 4 years, he captured over 100 hours of video, showing anomalous objects – in the daytime and at night. The video includes many extremely interesting apparitions – including a "UFO fleet" which was seen over Portsmouth for 6 hours on 18th October 2001. He filmed this at around 1:30pm. His wife also observed the object, which Woods described as "...not balloons, but intelligently controlled."

Four hours of clips of Woods' footage was passed to (now) retired British Transport Police Detective and UFO researcher, Gary Heseltine, who

compiled a catalogue of dates on which the footage was shot. Heseltine determined that:

- Woods had filmed anomalous objects on 50 separate days during a 3½ year period!
- About 90% of the footage was shot in daylight, with blue sky and some cloud.
- On many days, there were up to 8 or 9 segments of footage on a single day, meaning there were over 200 separate sightings!
- The objects were not balloons, as they were moving against the wind direction and interacting with one another.

It seems that Woods' success with filming [culminated in him capturing images of what I regard as one of the most unusual objects ever filmed/recorded](#)¹⁹⁰.

Woods, with his brother-in-law Tony, recorded a 4-minute sequence of an extremely unusual object on 27 Mar 2002. Tony was watching through binoculars. The object seemed to hover, display lights in sequence, turn around and then drift slowly, silently away. A still image is shown below. Many more stills can be found online, for example [in a series of five postings](#)¹⁹¹ on Rense.com and in [several internet forum posts](#)¹⁹².



Still from Anthony Woods' incredible video.

In Graham Birdsall's video, both Andrew Fry, a Digital Animator and Professor Roger Green, an image analyst, who has worked as an expert witness in court, report how they have analysed the video and both of them conclude there is no evidence of fakery.

Near the end of "The Journey" video, Woods states the following about his experiences and recordings:

I don't know what this means or where it's going. All I know is that it has happened and I've had the experiences since I was a child. I've been lucky enough to film all these sightings. I don't know what it is - but it's something real, it's something unexplainable. It's not mundane in nature. I'm just

looking for answers like everyone else. It's been positive for me. I deeply feel there is something significant behind it all, but what, I don't know. It's a journey and I just want to carry on until I find out the truth. This is definitely real.

However, on Jeff Rense's site, a note was added on 6 May 2004, which read as follows:

Anthony Woods would like it to be known that regrettably he has decided to distance himself and his family from the UFO subject. He has therefore ended all association with any and all parties who were previously involved in the release & promotion of his material. IF Anthony's footage or images have or are currently being distributed, sold or displayed publicly by ANY parties whatsoever, since the closure/liquidation of UFO Magazine UK as of February 2004, they do so ILLEGALLY! They are not authorized to do so, are in violation of copyright and Anthony's wishes. They do NOT represent Anthony Woods in any way, shape or form.

Anthony has agreed with the Rense site for his articles to remain on their site for posterity, exclusively. He would like to take this opportunity to thank both Jeff Rense & James Neff for the kindness and support they have shown towards him and his case. He would also like to thank the Rense visitors for their interest & support of his case over recent years. "If by showing my material has changed just one person's life or views on the reality of this phenomenon, then it was all worth it"

I have not contacted Anthony Woods or his family to discover what caused this statement to be made, although we can note that not long after the release of "The Journey" film, [on 19th Sept 2003, Graham Birdsall sadly died following a brain haemorrhage which he suffered eight days earlier, on 11 Sept 2003.](#)¹⁹³ He was 48 or 49 years old.

UFO Releases Spheres, Mexico - 22 May 2009

An astounding film, somewhat reminiscent of Anthony Woods' sequences, was aired on Mexican TV in May 2009. It showed a yellowish, jelly-like object releasing maybe 20 or 30 smaller objects along a horizontal axis running to the left and to the right of the object. [The object was filmed in daylight, against a blue sky, by Pedro Hernandez](#)¹⁹⁴. At around 5:15pm, he was travelling by bus in the Valle Dorado area of the city and he saw the object. He also filmed a plane as a "reference" object. As if this wasn't amazing enough, some weeks later, [another film of the same event emerged.](#)¹⁹⁵ It was shot by Alfredo Carrillo – who was clearly on the other side of the object – Hernandez's film was shot with the sun reflecting off the object, whereas Carrillo's film was shot looking more in the direction of the sun (i.e. the object – or objects – appeared more as silhouettes). A comparison still image from the later video is shown below.

Around the same time as this film was released in Mexico, the UK press preferred to discuss the MoD releasing some dull documents and Nick Pope talked about those, rather than this film.



Still from the comparison video.¹⁹⁵

A Small Selection of Powerful Witness Testimony

As a way of giving readers just a small taste of some of the witness testimony in Dr Steven Greer's disclosure project collection, I have included portions of two very compelling testimonies related to a UFO landing at Edwards Air Force base and an object that was inadvertently filmed during a "dummy" nuclear missile test in 1964.

Professor Robert Jacobs and a Nuclear Missile Test

I met [Dr Robert \(Bob\) Jacobs](#)¹⁹⁶ in Sept 2017 when he was at the Holmfirth UFO conference, filling in for [Robert Hastings](#), author of "UFOs and Nukes"¹⁹⁷ who could not attend the conference due to needing surgery. (A documentary based on Hastings' book, which can be rented online, was released in 2017¹⁹⁸.)

It is worth noting, at this point, how [Hastings' work on "UFOs and Nukes"](#) is [very significant](#)¹⁹⁹ and I recommend readers study the book and his website. There does seem to be a strong body of evidence that UFO/ET craft have shown a very strong interest in nuclear weapons facilities around the world. Disclosure Project Witnesses [Captain Robert Salas](#)²⁰⁰ and [Dwynne Arneson](#)²⁰¹ also testified to their own experiences.

Back to Bob Jacobs' case... Before [becoming a Professor of Communication, at Bradley University, California](#)²⁰², Jacobs had a career in the Air Force, reaching the rank of lieutenant in the field of Optical Instrumentation. He was based at Vandenberg Air Force Base in 1964, where he was involved in a project to film a nuclear missile as it passed through all three stages of powered flight.

As [Jacobs described in a year 2000 interview with Dr Steven Greer](#)²⁰³, the team he was working with had developed an advanced telescope which was used in conjunction with a movie camera to photograph objects over 100 miles distant. (The movie camera was attached to the so-called BU telescope, which had a very long focal length—about 180 inches or about 4500mm. This

meant that they could get a clear enough view of the missile in flight, even at a far distance.) To achieve this amazing feat, they had to use mounts which tracked the missile as it flew. They filmed the test from [Big Sur in California](#)²⁰⁴.

Jacobs describes the incident in detail in quite a number of interviews. He first did this in 1982.



Prof Robert Jacobs, Lt. US Air Force

...And sure enough, we could see all three stages of powered flight boosters, they burned out and dropped away. And then of course, to our naked eye, all we saw was a smoke trail going off into subspace, as it headed off towards its target which was an island in the Pacific. Well, that was our first filming of a launch and we got it.

We sent the film back down to the base and - I don't know exactly how long it was after the event, it might have been a day or two - I was called into Major Mansmann's office at the First Strategic Aerospace Division Headquarters. I walked into his office and they had a screen and a 16mm projector set up. There was a couch and Major Mansmann said "Sit down." And there were two guys in grey suits, civilian clothes, which was fairly unusual.

Major Mansmann said "watch this" and turned on the film projector. I watched the screen and there was the launch from the day or two before.

It was quite exciting. Because of the length of the telescope, as the Atlas missile entered the frame, we could see the whole third stage. That was pretty exciting optics. We watched that stage burnout. We watched the second stage burnout. We watched the third stage burnout. And then on that telescope we could see the dummy warhead. It's flying along and into the frame came something else. It flew into the frame like and it shot a beam of light at the warhead.

Now remember, all this stuff is flying at several thousand miles an hour. So this thing [UFO] fires a beam of light at the warhead, hits it and then it [the UFO] moves to the other side and fires another beam of light, then moves again and fires another beam of light, then goes down and fires another beam of light, and then flies out the way it came in. And the warhead tumbles out of space. The object, the points of light that we saw, the warhead and so forth, were traveling through subspace about 60 miles straight up. And they were going somewhere in the neighborhood of 11,000 to 14,000 miles an hour when this UFO caught up to them, flew in, flew around them, and flew back out. Now, I saw that! I don't give a Goddamn what anybody else says about it. I saw that on film! I was there!

Jacobs continues:

Now when the lights came on, Major Mansmann turned around looked at me and said:

"Were you guys screwing around up there?" And I said, "No sir!" And he said, "What was that?" And I said, "It looks to me like we got a UFO." Now the thing that we saw, this object that flew in, was circular, was shaped like

two saucers cupped together with a ping-pong ball on top. The beam of light came out of the ping-pong ball. That's what I saw on film.



From James Fox's "Out of the Blue," which features the interview with Robert Jacobs²⁰⁵

Attempts to cover up and debunk what Jacobs filmed have continued from that day to this, as Jacobs describes:

Now Major Mansmann said to me after some discussion about it, "You are never to speak of this again. As far as you are concerned, this never happened." And he said, "I don't need to emphasize the dire consequences of a security breach, do I?" I said, "No sir." And he said, "Fine. This never happened." As I started for the door, he said, "Wait a minute.... years from now if you are ever forced by someone to talk about this, you are to tell them it was laser strikes, laser tracking strikes."

Well, in 1964 we didn't have any laser tracking strikes. We didn't have any laser tracking at all. Lasers were in their infancy in 1964. They were little playthings in laboratories. So I said, "Yes sir, and walked out and that was the last I talked about it for 18 years."

In the interview and elsewhere, Robert Jacobs named several other people who he thought may have seen the film, but it appears that only his commanding, Major Florenze J. Mansmann, Jr. saw the film. In 1982, Jacobs decided to talk about the incident on a radio programme he was hosting at that time. He also had an article published in the National Enquirer Newspaper, after it was rejected by OMNI magazine. He stated:

And I was a part of a United States Air Force cover-up for 18 years.

After an article [came out about the incident], the shit hit the fan! I started being harassed at work. I started getting odd telephone calls that would come during the day. At night, at my house I would get telephone calls- all night long sometimes 3:00 in the morning, 4:00 in the morning, midnight, 10:00, people would call and start screaming at me. You are going down mother f_____! You are going down mother f_____! And that's all they would say. And they'd keep screaming that until I finally hung up the phone.

One night somebody blew up my mail box by putting a big load of skyrockets in it. The mailbox went up in flames. And that night at 1:00 in the morning the phone rang. I picked it up and somebody said, skyrockets in your box at night, oh what a beautiful sight, mother fucker!

I've been the subject of humiliating letters and phone calls from skeptics like James O'Berg at NASA and Phillip J. Klass, who's a paid informant of the United States Government who persisted in belittling me. And that's fine if they want to belittle me but don't belittle Sonny Mansmann!

As well as the personal attacks and harassment, Jacobs notes other aspects of how cover up works.

I believe this nutty fringe around UFO's is part of a concerted effort to keep serious study of it down. Anytime anybody tries to study this subject seriously, we are subject to ridicule. I'm a full professor at a relatively major university. And I'm certain that my colleagues at the university laugh at me and hoot and holler behind my back when they hear that I have an interest in studying unidentified flying objects- and that's just one of the things that we have to live with.

The Air Force denied everything. Was I in the Air Force? The Air Force denied it. Was I ever at Vandenburg? Well of course I couldn't be because if I wasn't in the Air Force how could I have been at Vandenburg? Did I put a tracking site up along the California coast? No, there was no tracking site in California. Which is a crock! The tracking site is still there right where I put it. And they use it to show you every time the space shuttle lands in California-that's where you first see it from. And they are still photographing missiles from Vandenburg from that tracking site.

Jacobs noted that later efforts by Lee Graham to track down Major Mansmann, Jr., were successful. Graham (and others who asked the same questions of Mansmann) received confirmation from Mansmann that the incident happened, just as Jacobs had described. Mansmann also added a few significant details in some of his communications about the incident:

The shape was [a] classic disc. The center seemed to be a raised bubble ... the entire lower saucer shape was glowing and seemed to be rotating slowly. At the point of beam release—if it was a beam, it, the object, turned like an object required to be in a position to fire from a platform ... but again this could be my assumption from being in aerial combat."

Later, Jacobs found out a little more about the aftermath of the incident. In the 2000 interview, he states:

I wasn't in the room at the time but what happened to the film is an interesting story in itself as Major Mansmann related to me and other people. Sometime after I had gone, the guys in civilian clothes - I thought it was the CIA but he said "No, it wasn't the CIA, it was somebody else" - took the film and they spooled off the part that had the UFO on it and they took a pair of scissors and cut it off. They put that on a separate reel. They put it in their briefcase. They handed Major Mansmann back the rest of the film and said here, "I don't need to remind you Major of the severity of a security breach;" we'll consider this incident closed. And they walked off with the film. Major Mansmann never saw it again.

The Air Force's position right now is there was no such incident and there was no film of it.

Further research by Robert Hastings²⁰⁶ documents how the debunkers simply lie and either distort or ignore evidence that is inconvenient to them and the vested interests they are willingly or accidentally serving. He mentions three people that have been involved with debunking attempts on the Jacobs Big Sur case.

In 1993, Kingston A. George, a former civilian colleague of Dr Jacobs, wrote an article for “Skeptical Inquirer” titled “The Big Sur UFO: An Identified Flying Object.” In this article, George claimed that Jacobs “concocted” the Big Sur UFO Incident, despite the already-available corroboration from Major Mansmann’s letter. One can consider George’s article libellous. Hastings notes that Kendrick Frazier, the person who published George’s article is guilty of “gross editorial incompetence” as Kendrick had “failed to catch the many factual errors and distortions in the article before releasing it to an unsuspecting public.” Hastings then notes that, for 20 years, Kendrick Frazier was employed as a Public Relations Specialist for Sandia National Laboratories, which has been involved with manufacture of the U.S. nuclear weapons since the 1940s.

Another name which we come across frequently in UFO-related literature is the late Philip J Klass. He was said by many to be a disinformation agent for the U.S. government, but he, of course, strongly denied this. Hastings notes that in correspondence with Prof Robert Jacobs, the CSICOP/CSI UFO debunker openly boasted about having “high-powered intelligence community friends.”

Hastings also notes that James Oberg who has also done “sterling work” as a NASA apologist and UFO and Moon Hoax debunker, repeatedly attempted to discredit Jacobs’ and Mansmann’s accounts. Oberg, himself a former USAF officer, worked on nuclear weapons projects at the Air Force Weapons Laboratory. In 1970-72, Oberg had also been a Security Officer within the lab’s Battle Environments Branch. He monitored security procedures used to safeguard the classified documents that were produced as a normal part of the branch’s operation.

Here again, however, we can also note how researchers and experiencers don’t seem to “reach beyond” certain boundaries. When [I presented at the 2017 Holmfirth Conference and included details about the cover up of what happened on 9/11 – and how Dr Judy Wood’s research proved that the WTC was destroyed with a directed energy weapon](#)²⁰⁷, Dr Jacobs asked a question right after my presentation and apparently had never heard of the idea that the official story about 9/11 was untrue. What I presented was, apparently “totally new” to him. I still bought him a drink afterwards though!

Mercury & Gemini Astronaut, Colonel Gordon Cooper

Some people will still claim that no US astronauts have ever reported seeing UFOs. Like so many statements made by folks who are just disbelievers, this statement turns out to be a lie. One Astronaut who has spoken out about their sightings and experiences is Gordon Cooper. [He started speaking out as early](#)

as 1978²⁰⁸. In a 1996 interview with Yolanda Gaskins²⁰⁹ for “Paranormal Borderline” he discussed his encounters with hundreds of unidentifiable flying



Gordon Cooper before his 1963 Mercury launch.

objects, when he was flying over Germany in 1951. He and several other pilots were flying F-86 jets - “We were super-sonic, barely.” He stated the following:

Yes, they were flying quite high - how high, we couldn't tell, because we couldn't get anywhere near their altitude. But they were either very large craft, way up, or smaller craft still well above where we could get to... We sent a report forward on it and [what] finally came back, months later, was [that] they were probably high-flying seed pods - which didn't sound very logical. They were flying faster and higher [than us].

In a 1996 interview with Michael Lindemann,²¹⁰ he gave further details of the incident, stating that they looked up and saw what appeared to be a large group of “double lenticular shaped” aircraft, classic flying saucers, flying in formation.

Cooper also described how, in 1957, his team *filmed the landing* of a craft at Edwards Air Force Base, while they were involved in recording data for a precision landing facility there. Cooper repeated the same statements 3 years later in an interview with James Fox. This was included [in the 2003 documentary \(already mentioned\) called “Out of the Blue.”](#)¹⁸⁶

As they were sitting there filming... a saucer came flying over their heads, put down three little landing gear and landed right out on the dry lake bed - and they picked up their cameras and started over toward it, filming as they went. And when they got in fairly close to it, it lifted up, put the gear back in the wheel wells, tipped up and took off at a great rate of speed. And so they ... came into my office and told me what happened. I sent them over to develop the film - and then had to go through all the proper regulations - of reporting this ... and we wound up having to you send the film forward to Washington, in the Base's jet airplane and I don't know whether anyone's ever seen it since.

In the later 2000 interview²¹¹, mentioned above, Cooper confirmed that he held the film up to the light to see that the object was on the film, but he did not have chance to run the film through a projector. He also stated the film was sent to Washington, being as it was, classified material and he never saw it again, nor did he ever hear any more about it.

Cooper made no secret of the fact that he had spoken to other pilots who had encountered objects while they were flying. He stated:

It was on Jim McDevitt's Gemini 7 mission where they saw this glint of something metallic off in the distance and he reported it, and nobody had it listed on the ground. So he tried getting a picture of it, but the Sun unfortunately was glinting off ... so all you got was just a glint. There was no detail on what it was. But never any further sightings at all on it.

Cooper even approached the United Nations with a proposal for a committee that would explore the UFO phenomenon:

The letter to the UN was in conjunction with a meeting that I had with Kurt Waldheim and the Security Council of the UN, to try to encourage the UN to establish a committee - to start comparing notes and data and information and to really look into all this, from an unbiased neutral point of view.

In this letter²¹², mentioned in his 2004 obituary²¹³, Cooper wrote:

I believe that these extraterrestrial vehicles and their crews are visiting this planet from other planets and are obviously a little more advanced than we are here on earth.

Also, in his obituary, Cooper is quoted thus:

I feel that we need to have a top-level, coordinated program to scientifically collect and analyze data from all over the Earth concerning any type of encounter, and to determine how best to interface with these visitors in a friendly fashion.

For many years I have lived with a secret, in a secrecy imposed on all specialists and astronauts. I can now reveal that every day, in the USA, our radar instruments capture objects of form and composition unknown to us.

Further information about Cooper's UN initiative can be found on [Lee Spiegel's website](#)²¹⁴.

It is interesting to note that in 1978, when Cooper wrote this letter, he was working for Buena Vista (a Walt Disney company) as an "Imagineer." It can also be noted that both Neil Armstrong and Buzz Aldrin have done promotional work for Disney.²¹⁵

Also, in the 1996 interview with Michael Lindeman²¹⁰, Cooper stated he was dropped from the Apollo Programme in favour of Alan Shepherd, though he was scheduled to head up a Mars programme (which was cancelled).

Cooper's statements regarding the UFO issue were clear and unequivocal, but the same cannot be said for statements made by Buzz Aldrin and Edgar Mitchell.

Inconsistent Astronaut Anecdotes

Edgar Mitchell

I discussed Edgar Mitchell's untrustworthiness in chapter 27 of "[Finding the Secret Space Programme](#)."⁴² and below, I include a relevant portion of this chapter.

In a documentary by David Sereda called "[Evidence: the](#)²¹⁶ [Case for NASA UFOs](#)²¹⁷," Sereda completes an extensive analysis of the STS 75 "[tether incident](#),"²¹⁸ discussed in chapter 6. (It is strongly recommended that you

review this footage for yourself.) As part of his investigation into this extremely unusual NASA footage, Sereda decided to contact Edgar Mitchell²¹⁹ and send him a copy of the NASA video. Sereda states that, in response to his query about the “tether” footage, on November 24, 1999 Edgar Mitchell wrote the following letter to him²²⁰:

David Sereda,

Yes, I have received your film and reviewed it and the info package you provided. I see utterly nothing about the tether incident that is particularly interesting. If there is more revealing footage then I will look at it. However, I have looked at many feet of space film, and have yet to see only one that has anything worth looking into regarding UFO appearances. Edgar Mitchell.

Sereda, unhappy with Mitchell’s response wrote to him again and Mitchell responded further, thus:

David,

At first glance they are just particles-----perhaps outgassed, I do not know. But I certainly would look for a more prosaic explanation than UFOs. If you have a better film, I will look, but I am not very optimistic they are anything exotic. EDM.

Still troubled by this new response, Sereda wrote to Mitchell again to ask him to study the footage more closely. Mitchell then responded:

David,

Okay, I will look at the tape, but be hard to convince that anything of significance is occurring. I am not impressed by physicists from M.I.T. or anywhere else in this arena. Blobs of light routinely appear on film if being reflected from some small object in space. Look up in the sky in the early morning and see the reflections from a satellite as the sun comes up-----the reflection is many times larger in apparent size than the actual object. Star light is the same. Distant stars would not be visible at all except for the spreading and diffusion of the light, which makes them visible. EDM

To understand how ridiculous Mitchell’s responses are, one needs to study the “tether” footage for oneself (so please do!) Of course, Mitchell needn’t have responded to David Sereda at all – it is as if Mitchell appears to be working hard to show himself as “a good guy.” That is, he has shown himself to be approachable and responsive to Sereda’s letters and questions.

It seems that Mitchell, when it comes to NASA’s own footage of UFOs/ET craft, is adopting a “limited hangout.” If you break down his other interviews, he essentially just stated he knew (unnamed) sources who “told him stuff” and he believed what they told him. However, he denied that NASA’s own video footage shows intelligently controlled objects or said he “couldn’t see anything interesting.”

Buzz Aldrin

In presentations I have given, which this book is based on, I have highlighted two contrasting sets of statements by Aldrin which show that he is not really being honest about what he knows. This is hardly surprising when one

considers his role in the Apollo Hoax (which I discussed at length in chapter 15 of “Finding the Secret Space Programme”⁴²).

In the documentary, “Apollo 11, the Untold Story,” broadcast on 24 July 2006 on the UK’s Channel 5²²¹, a story is recounted that “something” was following the Apollo 11 capsule (which didn’t go to the moon).

In the documentary, Aldrin stated:

Mike decided he thought he could see it in the telescope - and he was able to do that. And when it was in one position, it had a series of ellipses, but when you made it real sharp it was sorta L-shaped. That didn't tell us very much.

Now, obviously the three of us weren't going to blurt out, 'Hey, Houston, we've got something moving alongside of us and we don't know what it is,' you know? We weren't about to do that, because we knew that those transmissions would be heard by all sorts of people and somebody might have demanded we turn back because of aliens or whatever the reason is.

So we didn't do that - but we decided we would just cautiously ask Houston where... how far away was the SIV B? (A booster, jettisoned earlier in the flight).

A few moments later, they came back and said something like it was 6000 miles away because of the manoeuvre, so we really didn't think we were looking at something that far away, so we decided that after a while watching it, now it's time to go to sleep and not to talk about it anymore, until we came back - in debriefing.

Appearing on “Coast to Coast” on 31 July 2006²²¹, Aldrin chose not to discuss his Apollo UFO sighting with George Noory. Instead, he stated:

A guy by the name of Charles Berlitz wrote something about the Roswell incident and to establish his credibility, he had a little table in the front of his book, which attempted to take advantage of the alleged observations of people... of unusual sightings and he specifically referred to Anglia TVs reported... this... that... that had been sighted by somebody else... that Neil and I saw some green things... green creatures... Well, this kind of spoiled my credibility - and a lot of other people - so I decided to take him to court and sue him, because he was repeating phrases that were inaccurate...

*... Well, we won the suit and... hopefully it would cause a few people to be a little bit more careful in how they try and treat trusted servants of our government and of our people - to tell the truth. And I just feel like it's a little irresponsible of people - especially after so many years - to bring up subjects that have been explained thoroughly - **especially, in our case, in debriefings.***

These statements don’t seem quite as coherent as we should expect from someone who allegedly walked on the moon. They are more consistent with the conclusion that the person making them is not being totally honest. What, exactly, was Buzz Aldrin told in “debriefings?” Why would such “debriefings” need to include anything about UFO/ET-related stories? Is Aldrin simply confirming what Cooper stated about being “sworn to secrecy” (or words to that effect.)

Following these questions, I must also point out that the Berlitz claim is based on information from an unnamed source. This unnamed source allegedly gave Maurice Chatelain an alleged transcript of alleged comments made by Aldrin during the alleged moon landing. In chapter 1 of [the Berlitz Roswell book](#)²²² includes the following statements are included:

Aldrin: What was it?... What the hell was it? That's all I want to know.

Mission Control: What's there?... [garbled malfunction] ... Mission Control calling Apollo 11 ...

Aldrin: These babies were huge, sir... enormous... Oh God, you wouldn't believe it!... I'm telling you there are other spacecraft out here... lined up on the far side of the crater edge.... They're on the moon watching us.

The whole story is most likely a disinformation exercise. It is not even clear whether Chatelain ever worked for NASA in the first place! (This whole scenario can then be used to debunk the comments made by Gordon Cooper, which seem to be specific, detailed and honest – unlike Aldrin's, which are vague and even contradictory.)

Renewed Interest?

Here, we can note that in 2007, we saw a clear effort to link UFOs to National Security - a “Larry King Live” programme had two Disclosure Project witnesses (Capt. Robert Salas and Dr Robert Jacobs) talking about their experiences with Nuclear Weapons and UFOs. (We will cover these cases in brief in a later chapter.) Dr Robert Jacobs had been talking publicly of his experience since 1982 - so why did CNN pick it up only 26 years later? There was also a flurry over Dr Edgar Mitchell's statements – 12 years after he originally made them public. (I must now question the reliability of Mitchell's statements, because he never walked on the Moon, as he and others claimed – see chapter 27 of [“Finding the Secret Space Programme”](#)⁴²).

7. Wilbert B Smith - from Sceptic to Contactee

This chapter is adapted from an article written in July 2013, which was itself based on a presentation I compiled in 2003, from research completed by Grant Cameron and others.

“The human race in the form of man extends throughout the universe and is incredibly ancient.”

These were the words of a certain Canadian radio engineer in a speech he recorded on March 31, 1958 at his home in Ottawa Ontario Canada.

I discovered these words, sometime in 2003, thanks to the wonderful website of the extremely knowledgeable Grant Cameron. That website is www.presidentialufo.com (now “moved” to an archive area²²³) – and it contains a great deal of useful and compelling information and evidence pertaining to the US Government’s and US Presidential knowledge of the UFO/ET issue. Cameron, who became interested in this subject following his personal UFO/ET related-experiences in the 1970s, had been collecting information on Wilbert Smith for about 25 years and he had posted a small selection of it on his website. Other researchers, such as Arthur Bray have also collected and preserved Smith materials and prevented their untimely removal by government employees. Back in 2003, I obtained a CD copy of Grant Cameron’s collection of Smith related files. When I “opened” this treasure trove of information, it became clear to me that a lot more was known about UFO’s/Flying Saucers in the 1950s than I ever realised – at least, things were known by those who chose to seriously investigate the available evidence...

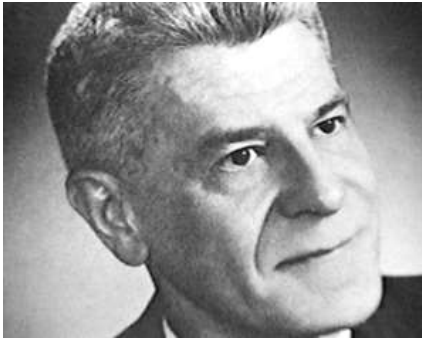

Wilbert Brockhouse Smith (1910-62) Canadian
Radio Engineer

Wilbert Brockhouse Smith is not a name which normally comes to mind for most people when they are discussing the evidence pertaining to UFO’s and extra-terrestrial intelligence. Indeed, most people tend to confuse Wilbert Smith with Wilbur Smith - the author of numerous historical fiction novels. Wilbert Brockhouse Smith was himself a writer, though his main work, “[The New Science](#)”²²⁴ was never finished,

but a small number of copies were still published. Wilbert Smith was a rare individual indeed – naturally inquisitive, kind-hearted, methodical, analytical, thorough, resourceful - yet open-minded. Some of his writings read like those of a spiritual leader, whilst remaining grounded, straightforward and accessible.

Wilbert's Wisdom

When I first came across Wilbert Smith, I strongly identified with his writings and conclusions – perhaps because we have both worked in engineering disciplines – which are all about solving problems.

Perhaps unusually, for someone like Smith, through the 1940s and 1950s, he rose to a high position in the Canadian Government and eventually became the Superintendent of Radio Regulations. He was a contemporary of people such as [Major Donald Keyhoe](#)²²⁵, George Adamski (discussed in chapter 8) and the legendary Frank Edwards, who all played a significant role in developing our knowledge of “The Boys Topside”, as Wilbert Smith came to call them. His research and experience encompassed most areas of the UFO field – sightings, contacts, inspection of UFO-related artefacts and even the viewing of alien bodies.

Wilbert Smith was born in Lethbridge, Alberta, Canada in 1910 and he graduated from the University of British Columbia (UBC) in 1933 with a B.Sc. in Electrical Engineering. Following this, he obtained his MSc (Master's Degree) in 1934 also at UBC. In 1934/5, he became chief engineer for the CJOR radio station in Vancouver. In the years following, at certain times, he acted as a consultant to the Government and in 1939 he joined the federal Department of Transport.

Smith was engaged in the engineering of Canada's war-time radio monitoring service and following this, in 1947, he was put in charge of establishing a network of ionospheric measurement stations, several of which were in isolated parts of Northern Canada. He eventually became Superintendent of Radio Regulations Engineering with the Department of Transport [DOT] His technical research was in Radio Wave Propagation, where he came across such topics as auroras, cosmic radiation, atmospheric radio-activity and geomagnetism (the Earth's Magnetic Field). It was likely this area of science which made him more interested in the Flying Saucer Phenomenon (he rarely called them UFO's – as that term was not coined until 1952, by Edward J Ruppelt).

He continued to work for Department of Transport until his death in 1962 (he died of Cancer of the Lower Bowel). At the time of his death, he held 37 patents. He was married, to Murl and they had 3 children.

His interest in “flying saucers” probably was triggered by a magazine article. Initially an extreme sceptic, he began to investigate “saucer” cases himself, developing questionnaires for witnesses and contactees and carrying out methodical studies, to gather and analyse data about the phenomenon.

In 10 years of research, Smith's understanding developed and he began to see “the bigger picture”. He realised the key role that awareness and consciousness played in the phenomena that he was investigating. Over 50 years later, there is much more general discussion in the Alternative Research Community of the topic of consciousness in relation to ET's and UFO's. Smith had a more analytical approach than most and his writings are much

more concise and focused than most of the wide range of material that is now available.

The “Top Secret Memo” and “Project Magnet”

I include here some of the same information that I included in chapter 4 of “Finding the Secret Space Programme.”²²⁶

If Wilbert Smith’s name comes up in UFO research, it is usually in relation to the “Top Secret Memo” which he wrote to the Canadian Dept. of Transport in 1950.

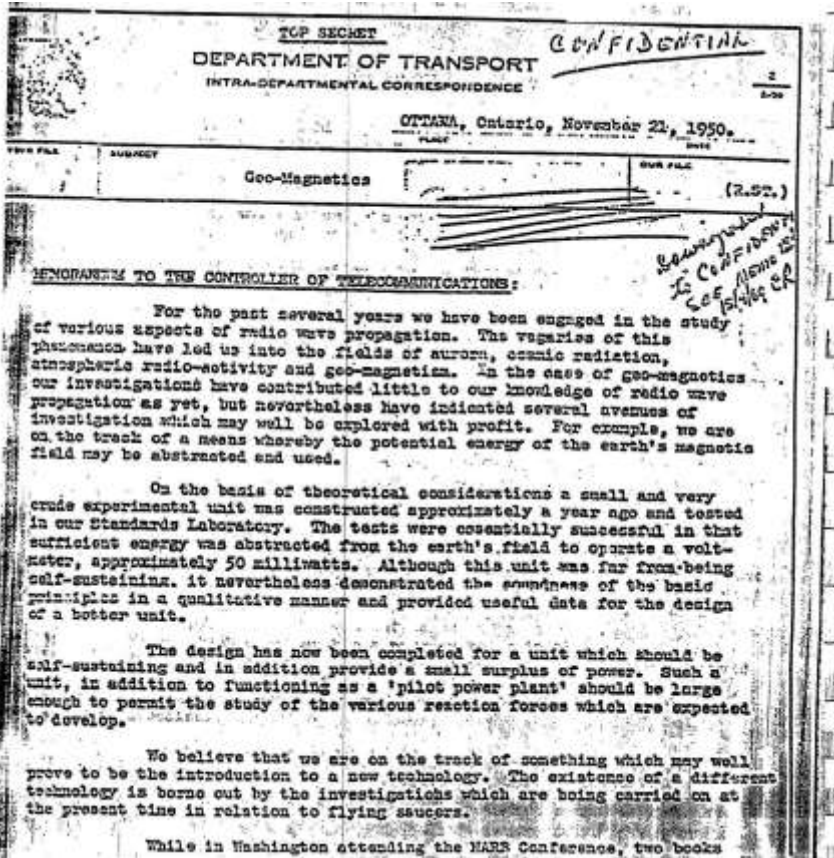

First Page of 1950 Top Secret Memo

A draft copy of this document was declassified by the Canadian government in 1979. In this vital document, discovered by Nick Balaskas in the University of Ottawa Archives, Smith discloses the secrecy classification on the study of the “saucer” phenomenon. Smith wrote:

- a. The matter is the most highly classified subject in the United States Government, rating higher even than the H-bomb.
- b. Flying saucers exist.

c. Their modus operandi is unknown but concentrated effort is being made by a small group headed by Doctor Vannevar Bush.

d. The entire matter is considered by the United States authorities to be of tremendous significance."



Dr Robert Sarbacher in 1950

When you really “get down to it,” and understand that this was a real document, written by a gifted radio engineer, you have to consider the question “Who gave Smith this information?” Further research, in 1983, by Nuclear Physicist and veteran UFO investigator Stanton Friedman, revealed that the information about the classification of the UFO subject appears to have been given to Smith by Dr Robert Sarbacher - a Physicist. Sarbacher, who worked as a consultant to the US Dept. of Defence - DOD would later go

on to create the Washington Institute of Technology. Of equal or even greater interest, however, is what Smith wrote in the next paragraph:

“I was further informed that the United States authorities are investigating along quite a number of lines which might possibly be related to the saucers such as mental phenomena and I gather that they are not doing too well since they indicated that if Canada is doing anything at all in geo-magnetics they would welcome a discussion with suitably accredited Canadians.”

As I understand things, it is not clear who gave Smith the information about “mental phenomena” – it wasn’t Sarbacher. It is rare to see these sorts of concepts brought up in de-classified government documents.

We will return to this “mental phenomena” issue later in this chapter.

Smith, like any good engineer, was curious to find out more – in the hope that he could use any findings to solve problems. So, Smith proposed setting up a project to investigate Saucer Phenomena:

“It is therefore recommended that a PROJECT be set up within the frame work of this Section to study this problem and that the work be carried on a part time basis until such time as sufficient tangible results can be seen to warrant more definitive action. Cost of the program in its initial stages are expected to be less than a few hundred dollars and can be carried by our Radio Standards Lab appropriation.”

The “Project” became known as Project Magnet. Though officially, Smith’s Flying Saucer interest was private, in reality he used his knowledge and government position to instigate a semi-official study of the Saucer Phenomena. The proposal was accepted and a “station” was set up at Shirley Bay, about 20 miles outside Ottawa (where the Department of Transport’s Communications monitoring facility was situated). This Area was later to be used by the DOD.

The project ran for about 3 or 4 years, with the aim of gathering information about magnetic phenomena. It was meant to be classified in case the results

yielded a new insight into magnetic phenomena which might be exploited. Contrary to some descriptions, it was never officially called a “Saucer Detection Station” and its existence was only reluctantly acknowledged during Smith’s lifetime.



1954 - Project Magnet Research Station at Shirley Bay

As the story goes, on August 8th, 1954, at 3:01 P.M., after 8 months of watching flat lines on graph paper, the equipment appeared to detect something significant. At the time, almost predictably, the area was completely fogged in (an unusual time of day and year for fog!). However, word of this “got out” and made headline news, as Smith later discussed in a lecture he gave. This resulted in both the Shirley Bay Observatory and Project Magnet being shut down on August 10, 1954.

After Smith’s death, the strength of denials about the project seemed to increase. A statement prepared for the Minister of Transport to be presented in the House of Commons in the 1950s, for example said, “This entire program . . . is being carried on . . . with official approval and authority to make use of existing facilities.”

Months after Smith died in late 1962, Mr. Dupuis, Minister of the Department of Transport, made a statement, still acknowledging the project, in the House of Commons:

Between December 1950 and August 1954 a small program of investigation in the field of geomagnetics was carried out by the then communications division of the Department of Transport with a view to obtaining, if possible, some physical information or facts which might help to explain the phenomena which was generally referred to as unidentified flying objects. Mr. W.B. Smith was the engineer in charge of this program.

However, it was 2 years later in 1964 that an Ottawa UFO researcher Arthur Bray, wrote to request information about Project Magnet. Bray received a letter that started the denial:

... at no time has this Department carried out research in the field of unidentified flying objects . . . The department did not take part in any of his (Smith's) research work nor did Mr. Smith provide the Department with any useful information arising out of his work.

Arthur Bray later became a custodian of many of Smith's files and kept them safe for about 20 years.

By 1968 the denial was completed. Dr Peter Millman, a UFO sceptic at the Dominion Observatory, wrote the statement that would forever be provided for inquiries related to Smith and Project Magnet. Millman wrote:

The project was a personal one carried out by Mr. Smith with the knowledge of his department, but without any official sponsorship.

Frances Swan, Affa and Ponar

The Wilbert Smith story is one that encompasses several areas of the UFO/ET field. Another interesting episode relates to Smith's association with Contactees. More than one of these contactees claimed to be in communication with two ET's that were in spacecraft near to the earth. Smith met a woman called Frances Swan in 1954, through Rear Admiral Herbert B. Knowles, USN (Ret.). Knowles held important submarine commands in World War II and he was active in encouraging witnesses to report sightings to the NICAP (National Investigations Committee on Aerial Phenomena - Major Donald E Keyhoe was also a member of this committee.) Frances Swan, who lived near Knowles, was apparently "channelling" messages from 2 entities named Affa and Ponar who were flying 2 ships M4-M4 and L11 respectively. Knowles had become concerned about 2 mysterious "satellites" which orbited the Earth in 1953 and 1954 (one of which reportedly came in and hovered over the Pentagon at 90,000 feet.) Several newspapers of the time reported the discovery of these satellites. Of course, this was about 3 years *before* the launch of Sputnik 1.



Frances Swan

In relation to the satellites, Vice Admiral Knowles asked Swan technical questions, which she was able to answer. This convinced Knowles she had genuine knowledge. Perhaps it is unsurprising that Swan was later investigated by the FBI.

[Another account on Grant's Website](#)²²⁷, written by Jay Gourley and originally published in May 1979 in "Second Look Magazine" tells of when Swan tried to arrange a meeting between Affa, Smith, and some Government officials at 2 p.m. July 6, 1959, in a secret government

office, concealed on the top story of a garage at 5th and K St., N.W., Washington, D.C. At the meeting, the officials, including Robert Friend, an Air Force major, asked Swan some technical questions and she wrote out the

answers given to her by Affa. They then asked that Swan's contact prove that he existed. After instructions were given to look out of a nearby window, Robert Friend witnessed a saucer-shaped object fly past. Not surprisingly, the documents about this meeting were originally classified!

4C Fri. May 14, 1954 ST. LOUIS POST-DISPATCH

Artificial Satellites Are Circling Earth, Writer on 'Saucers' Says

WASHINGTON, May 14 (AP) — Donald E. Keyhoe, who wrote a book about such things, said last night the earth is being circled by one or two artificial satellites, and Secretary of the Air Force Harold Talbott personally has seen a "large, silvery, disk-shaped object" in the sky.

Talbott, however, promptly denied he had ever seen a flying saucer. Not, he added, that he had not had his chances.

"I have never seen a flying saucer," said Talbott in a statement. "I am convinced it is not from lack of opportunity. During the last 15 months my official travels have taken me more than 160,000 miles without encountering one."

Keyhoe, a retired Marine Corps major, wrote the best-seller, "Flying Saucers from Outer Space."

In an interview with commentator Frank Edwards of Mutual Broadcasting System he said three "very important developments" concerning unidentified flying objects have been kept from the public.

These, he said, are (1) the artificial satellites he reported (2) what he said Talbott saw, and (3) notice from Canadian Government scientists to all official sky watchers within the last two weeks "to be especially alert and to report immediately any unidentified aerial objects."

United States Government scientists at White Sands, N. M., Keyhoe said, are making an intensive effort to locate and chart the course of the satellites in an attempt to determine what they are and where they came from.

Swan stated that, on many occasions she was in contact with Affa, over a period of several years. In Grant Cameron's collection of Smith-related files, there are over 100 typed pages of messages channelled by Swan from Affa. These messages are a "bit of a mixed bag," with one message predicting that the world would end in 1956! It seems this is a recurring theme in messages from alleged ET's – one of impending doom.

One interesting coincidence is that Frances Swan lived in Eliot Maine, only a few miles from Portsmouth, New Hampshire – where Betty and Barney Hill lived. We will examine the Hill's case in chapter 10.

Binding Meter and Caduceus Coil

As part of Project Magnet Smith, conducted some experiments in which he showed it was possible to extract energy from the Earth's magnetic field. He thought this is what Saucers used for both propulsion and as an energy source. He described this device as a magnetic "sink" (which energy would "flow into").

After a time, Smith seemed to have established a line of communication with “The Boys Topside,” as he sometimes called them. He actually built several items of simple experimental hardware according to instructions given to him by “The Boys Topside”. In a lecture in 1958²²⁸, he said he thought it was “absolutely regrettable” that his group (in Ottawa) was the only one turning the information into “real hardware.”

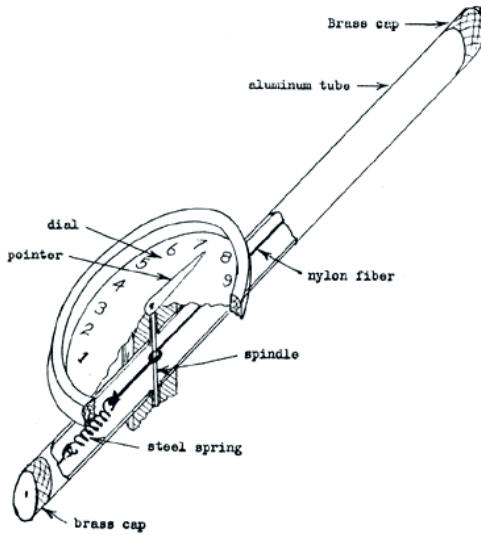

BINDING METER

Sketch of Design of Smith's Binding Meter

Being an Engineer who designed and built radio equipment, Smith and those he worked with were quite capable of building these items. The first item was a “binding meter²²⁹” – it basically consisted of a wire and a spring connected, in a particular way, to a dial which could be used to measure “binding force” in the local area. The scale reading should normally be static even with variations of temperature and pressure – and Smith tested this before giving a few of the meters out and testing them in different areas, and they did indeed give different readings.

Smith said he was told that materials were subject to “binding forces” and, for example, objects coming close to the saucers could be affected because the binding forces were altered by the craft's operational field. In the same 1958 lecture, mentioned above, Smith stated he thought that Thomas Mantell's plane broke up because it got too close to the craft and the altered binding force caused the plane to “fall apart”. Current physics does not acknowledge this type of force – but, I can certainly see, in the research of Canadian Experimental Researcher, John Hutchison and in what we witnessed in the destruction of the World Trade Centre on 9/11²³⁰ (as analysed by Dr Judy Wood in her book “Where Did the Towers Go”²³¹), could very well be the

result of an alteration of the “binding forces” in the materials which are affected.

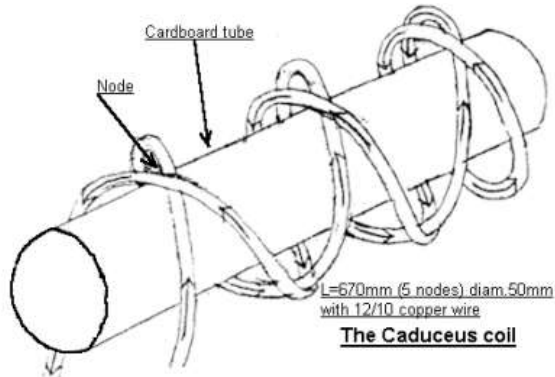

Rough Schematic of Caduceus Coil – Similar to the one Smith made, though the ferrite core in his was hollow.

Another item, which Smith made and was quite proud of, was a special type of coil (as used in AM radios, transformers, car engines and other electrical apparatus). It is prepared and wound in a very particular way. Smith found that when he tested it with his radio equipment, it would completely absorb radio wave energy of a certain frequency. This appears to violate the accepted laws of Electro-magnetism. (That if radio energy goes into a coil, it should come out as other radio energy, a magnetic force, electricity or light, heat or mechanical energy - vibration.) When he set his experiment going and found this result, he was told by the Boys Topside that he had successfully generated “tensor energy” – which they used for “just about everything.”

Gravity Control (Antigravity)

Another area that Smith spent a long-time investigating was experiments with a rotating disk. (I wrote about this in more detail in chapter 4 of [“Finding the Secret Space Programme.”](#)²²⁶)

Due to his investigation of the Saucer Phenomenon, Smith postulated (in simple terms) that the force of Gravity was actually the result of interacting magnetic fields that objects themselves generated, rather than it being a separate force, as traditional physics suggested. He determined that the speed of rotation of an object can be used to influence gravity and he and his team designed experiments to test this. In 1959, during one of Smith’s Gravity Control Experiments in his lab, they were rotating a copper plate at 15,000 – 18,000 rpm. The phone rang and another of Smith’s contacts, a Telex Operator in Ottawa reported he had had a message from Affa saying the experiment needed “shielding”. They built a brick wall around the experiment which did, indeed “blow up” on the next run!

Saucer Hardware and Alien Bodies

Smith corresponded with several people stating he had handled a number of pieces of Saucer hardware (said to be from crashes or military encounters) and

he had been involved in their analysis. Art Bridge, one of Smith's associates stated that they were also involved in analysis of "a lot" of hardware. Wilbert's son Jim Smith also handled one or more of these pieces. In March 2002, James Smith was a guest on the Toronto CFRB radio Talk show "Strange Days... Indeed", where he described the UFO hardware which was sent to his father from the United States. James Smith described that, probably when he was in his teens, he handled a small piece of the hardware that his father received for analysis. The piece was fairly heavy, about the size of a house-brick, semi-circular in shape, very smooth, apart from where it had been broken off from whatever it was connected to. James Smith did not know what happened to any written reports about the analysis of these pieces of hardware.

[An interesting article compiled by Grant Cameron and posted on his website](#)²³² reports a number of additional facts. For example, a memorandum from "Vannevar Bush to Colonel Wood" in the "Research and Development Board Files" at the National Archives has this quote:

"We must depend heavily on the Canadians for investigation of communication, navigation, projectile control methods and ionospheric measurements in the all-important auroral belt. Interchange of technical information should be uninhibited to enable us to gain necessary Canadian information so that studies of the earth's magnetic field may be completed."

(These areas are similar to what Project Magnet was investigating.) The channel of communication was through the liaison of the Research Defence Board of Canada, which was "charged with the establishment of all policies in the field of military research and development as well as exercising the executive functions of administering all the research and development installations in the Military Establishment."

In his article, Grant Cameron relates how a 1997 Usenet message from a former President of the Montreal Flying Saucer Club (which had contacts with the group Smith was involved in – the Ottawa Flying Saucer Club). He, and other members of the Montreal group had visited Ottawa in early 1964 and stayed over-night at Mrs. Smith's home. During supper, Mrs. Smith stated to the group that Wilbert Smith had personally viewed dead alien bodies. In an e-mail to Grant Cameron, the group member stated:

"We were told about the bodies that Wilbert Smith had seen when he was personally invited by the US military. We were simply told that he saw the bodies and from the impression that I received it was for only a short time - minutes not hours... Mr. Smith described (to his wife) the dead occupants as having been approximately 4.5 to 5 feet in height, grayish blue tint to the skin, large eyes, small slit for a mouth and four long fingers with no thumbs."

In the CFRB talk show interview, mentioned above, James Smith was asked [about his father viewing alien bodies](#)²³². James stated that he had been told about the bodies as his father was near death. The viewing probably happened on one of Smith's many trips to the USA. Correspondence from the Canadian Embassy in Washington during 1951 indicates that during that period Smith was dealing, at least indirectly, with Vannevar Bush at the Research and

Development Board in Washington, D.C. Bush, being the head of the U.S. flying saucer effort would have been able to give Smith access to craft and bodies. James Smith did not remember the use of the term “greys” in his father’s statement described the aliens as “small humanoid” and “like descriptions of the time.” These descriptions were in agreement with those made by many other people having alien encounters in the fifties. They would also agree with Smith’s notion that aliens were not much different to us and might even be our “distant relatives”.

In relation to this story, we can ask “If Smith saw the alien bodies, where did they come from?” In the conversation between Stanton Friedman (who is discussed in a later chapter) and Sarbacher in 1983, Sarbacher refers to “UFO crashes.”

In correspondence,²³³ Sarbacher implied that he had heard about beings that were recovered being “insect-like,” though he had had no direct involvement either with recovery of the craft or any of the hardware, but he did confirm a certain name, from a list of names given to him, who he thought was most likely to have been involved with a secret group dealing with this. (It appears that Sarbacher was talking about different beings to ones that Smith saw.) In a letter to William Steinman, dated 29 November 1983,²³³ Sarbacher stated “John von Neuman was definitely involved. Dr Vannevar Bush was definitely involved, and I think Dr Robert Oppenheimer also.”

Some follow-up research related to the Sarbacher account was completed by a researcher named D.M. Duncan.²³⁴ He spoke to Robert Sarbacher’s son, who revealed the following about some of the work his father was involved in:

He knew that they [the saucers/UFOs] were real for the obvious reason that they would be going 600 mph and then make a direct 90 degree turn in mid-air without slowing down...separated from all inertia and gravity. Dad said that the reason he was called in was to build the right kind of missile to track these things since they were way too fast for any of our planes to catch. They wanted the missile to not destroy any of the UFOs, but to be able to track them. So Dad had cameras installed (like on the V-2 rockets) so when the UFO comes into our air space, we would shoot missiles at them with cameras on them, since only a missile could keep up with the speed turns.

Duncan was so surprised, he asked for clarification. Sarbacher’s son then stated,

Yes, exactly to track UFOs, or rather to photograph and watch them...When he first told me about the missiles...the first thing I thought was, what? You were trying to destroy them? He (Sarbacher Sr.) said very normally and matter of factly, “No, we put cameras on the end of them.”

If you follow the links above, you will see that the V2-related information is true. It is also the opinion of Grant Cameron that, partly via Sarbacher, Wilbert Smith did obtain clearance to work with folks in the USA²³⁵, hence there is strong evidence that Smith was, indeed, in contact with exactly the right sort of people that could have given him access to bodies and hardware, especially considering Smith’s considerable knowledge, based on his own research into aspects of the phenomenon.

“No Point in Investigating...”

Smith’s feeling about the phenomenon evolved over time. He knew, from his own experience, that he was dealing with something that was real. In a letter to a Mr McClelland dated 20 Aug 1958, Smith expressed that he felt there was little point in trying to establish the reality of the phenomena, or “ploughing and re-ploughing the same field”. He pointed out there was more than enough evidence available to prove the reality of the ET’s/UFOs. He had become more interested in finding out more about the *meaning* of the phenomena – which he said lay in the field of metaphysics. Some of the concepts he had come to understand were discussed in an address he recorded in 1958.

August 20, 1958

Dear Mr. McClelland,

Thanks for your letter and enclosure of August 11. I got quite a kick out of the newspaper clipping but I have run against the same sort of thing myself. I once investigated a sighting, and after making copious notes of the weird occurrence, the gentlemen assured me that if the Department would be good enough to provide him with a good pair of binoculars he would guarantee to see lots of saucers!

Some time ago I was asked to prepare an article for the Flying Saucer Review, London, England, and so I sent off a copy of a document which I had prepared in response to numerous enquiries as to my own position in regard to the saucer phenomenon. I am enclosing a copy which you may present to your club if you wish.

Although I am on the Board of Advisors for NICAP, I haven't done much advising so far. Major Keyhoe runs it pretty much along his own lines, with which I do not entirely agree. For example, I do not think any great progress will be made as long as the Keyhoe- Air force feud continues. I think more effort should be placed on the meaning of the phenomenae rather than plowing and re-plowing the field to prove the reality of UFOs. Goodness knows, there is more than sufficient evidence already published to convince the most hard shelled skeptic, if they will only take the trouble to read it.

Our club here is most anxious to exchange any information we may have with other clubs, but so far our unit has relied rather heavily on my own investigations and experience. Several of our members have seen UFOs and we have carried out a couple of sky watches, during the course of one of them we saw a saucer streaking overhead, no details visible.

Must close for the present, as I have other obligations, this evening being meeting night for my Village Board, of which I am chairman.

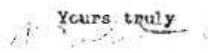
Yours truly

W. B. Smith

1958 – The Ottawa Address

The opening sentence of this article came from the [1958 Ottawa address which Smith recorded on 31 March](#).²³⁶ When I first heard this in 2003, a lot of what Smith said resonated strongly with me. [It is worth listening to this address](#)²³⁷, which runs for about 18 minutes – Smith covers a lot of ground, in his usual concise and focused manner. He describes his general approach to research and how his initial findings were “exactly parallel with other investigators” and he states clearly that he understands he is dealing with real

accounts about real things that people have seen and experienced. He discusses the case of Thomas Mantell in 1947 (which was one of the first UFO cases I'd ever heard of - when I was 10 years old). He then discusses his conclusions about being in contact with aliens, through quite a number of people. He stated:

While we were able to establish that these people from outside all told the same story, was that story true?

Having considered this question carefully, Smith stated:

I began for the first time in my life to realize the basic one-ness of the Universe and all that is in it – science, philosophy, religion, substance and energy are all facets of the same jewel, and before one facet can be appreciated, the form of the jewel itself must be perceived.”

We started this chapter with Smith's quote about “man” being spread throughout the cosmos. He said more in relation to this:

*One of the most important things that I had to realize is that we are not alone. The human race in the form of man extends throughout the universe and is incredibly ancient. Also, its appearance in the physical form is but one of the many manifestations along the path of progress. Our civilization here on earth now is only one of many that have come and gone. The planet has been colonized many times by people from elsewhere, and our present human races are blood brothers of these people. Is it any wonder that they are interested in us? To orthodox thinkers this may seem strange, **but not nearly so strange as our orthodox ideas on evolution.***

Elsewhere in his writings, Smith questioned the theory of Darwinian Evolution²³⁸, thus:

The Darwinian theory of evolution shows certain relationships between the various forms, which inhabit this planet, but there is very little evidence to indicate that they all evolved here. Maybe some of them did, but a more reasonable explanation is that they were brought here when the planet was in a suitable condition to receive them.

We will revisit this idea in a later chapter (again, I think Smith was correct in stating this.)

There are several other components of this address which succinctly tie together several “dimensions” of the UFO/ET/Consciousness phenomenon in a profoundly meaningful way –in a way which is more relevant now than ever before in our history. For example, Smith stated:

I am told that, as far as we are concerned there are twelve dimensions of deity, and these provide the entire structure of our Universe. Our conventional concept of dimensions is most inadequate and restrictive, and so long as we persist in them, we can never transcend the world of mechanical processes, which we have built.

Perhaps even more profoundly, just before the above statement, Smith also clearly stated his thoughts on the idea of “pre-destination” – the idea that our lives are planned out in some way before we are born:

When we enter this life, we do so to participate in certain events, the sequence of which were established before our birth, and if altered

substantially would deprive us of experiences necessary to our development. We have built-in protection against altering substantially the sequences in that we do not seriously know of them. But these people from outside have a much greater knowledge than we have, and have a means of perceiving sequences, which must not be changed.

Further, Smith states something which I strongly identify with. In considering the idea that benevolent ETs are here, some people ask, “why don’t they directly help us?” Smith sums up the fundamental difference between guidance and overt intervention in the affairs of those you may care about:

Therefore, while they have every desire in the world to help and stand by ready willing and able to do so, they are not permitted by cosmic law to interfere. The dividing line between help and interference is very delicate indeed, and sometimes hard to perceive, but it is a demonstration of individual and collective progress as to how well we can be guided by it.

Knowing

Smith also wrote about how religion is a “bit of a problem” in relation to understanding our true nature. In a piece he wrote called “[The Five Faces of Man](#)”²³⁹ he explains:

The first relationship is Religion, which is the relationship of a being to its Creator. Here we have a hodgepodge of superstition dressed up in pagantry giving lip service to something in which very few people actually believe, and practically no one knows anything about. Every great religion says “Love Thy God” but how many understand what this means? We think we know family love, love of country, love of things, but do we know love of God?

He continues:

Love Thy God with all Thy Heart, with all Thy Soul, and with all Thy Mind! Here again we are urged to a course of definite action which is spelled out rather clearly, and again we do little or nothing about it. We must learn to know our hearts, our souls and our minds: to know their capacity and then to use this capacity. There is a tremendous potential here if we but understand it.

Here, Smith talks about **knowing** – knowing yourself, your heart - and understanding “where you’re at.” Perhaps it means accepting that at any given time, there are things you *do* know and things you *do not* know. Knowing is the opposite of believing. Smith didn’t really talk about consciousness all that much but in his notes, the chart below was discovered. The source of this chart is unknown - I don’t know whether Smith drew this chart or not. It seems to be some kind of graph relating to the development of human consciousness, however.

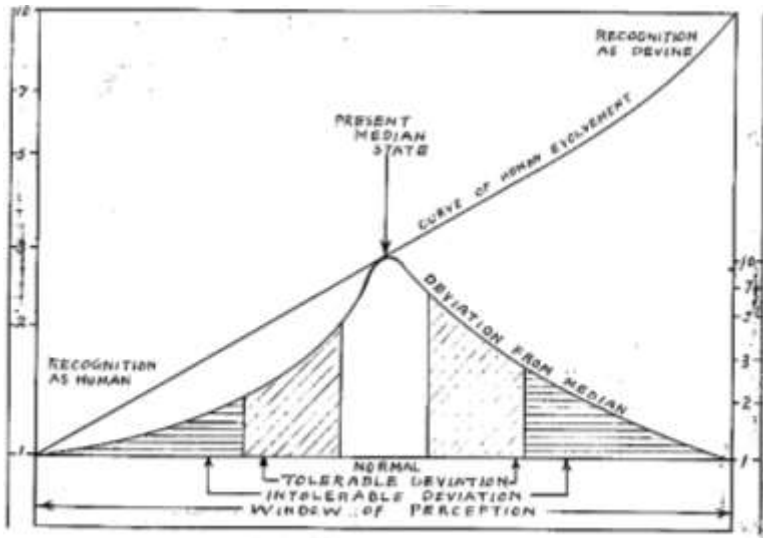

Smith, in his 1958 address also stated that:

These people tell us of a magnificent cosmic plan, of which we are a part, which transcends the lifetime of a single person or nation or civilization, or even a planet or solar system. We are not merely told that there is something beyond our immediate experience - we are told what it is and our relationship therewith.

I am just guessing, but perhaps this chart somehow relates to this statement. The matters of transcendentalism, altered states of consciousness and spiritual ideas and research are not central features of this book, but there are plenty of other people who have written books on these topics – both linked to and separate from the UFO/ET phenomenon. I think these areas are inextricably linked – and at this point, it seems pertinent to remind ourselves of what the late Ben Rich, head of Lockheed Skunkworks, reportedly said in a short conversation with Jan Harzan in 1993. According to people who attended a lecture by Ben Rich about his 40 years at the Lockheed Skunk Works, given at an Alumni meeting of the School of Engineering at UCLA on 23 March 1993, Rich showed a slide of a Black Disc zipping off into space to end his talk. Rich then said:

We now have the technology to take ET home.

After the talk Rich took questions. Someone asked where the technology came from. Rich mentioned that during research relating to the technology, they had found that “there was an error in the equations and that they had found the error and now knew how to travel to the stars – within one’s lifetime.”

[Jan Harzan, Director of MUFON asked Rich some further questions and followed him out to the car park \(parking lot!\)²⁴⁰](#) Harzan said that he had interest in this technology from a personal standpoint and he wanted to know how it worked. Rich asked Harzan the question, “How does ESP work?”

Harzan replied, “I don’t know ... all points in space time are connected?” and Rich replied, “That’s how it works.”

New Science

Perhaps because of the conclusions Smith came to, and summarised in the Ottawa Address, in the last few years of his life, Smith turned his attention to the task of trying to rewrite the whole framework of aspects of physics and scientific thinking from the ground up, based on what he had learned from his experience and his experiments - and from what “The Boys Topside” had told him. At the beginning of his unfinished book [The New Science](#)²²⁴, Smith writes: “Assembled by W. B. Smith from data obtained from beings more advanced than we are.” The work is available on the Internet, and deals more in “Metaphysics” initially, rather than Science, describing concepts of “nothingness”, “awareness”, “reality”, “space” - terms which he shows must be defined and understood properly, if we are to develop a new understanding of the Cosmos around us and our place within it.

Audio Recordings

Grant Cameron and others have also preserved [several hours of compelling audio recordings of Smith and his associates](#)²⁴¹. These recordings, even today, jolt our grey matter in surprising directions. There are very few people who had the experience and knowledge to state what Smith states in the way he stated it. Wilbert Smith wrote in answer to those who challenged the truth of what he said by saying

I make no attempt to ‘prove’ anything and have no intention of doing so. It is up to each and every one to search out the truth and decide for themselves just what is truth. Truth needs no justification; it stands alone.

Summary and Conclusion

Since I first came across the Wilbert Smith evidence and accounts in 2004, my opinion of it all has not changed. I still regard the totality of evidence collected by Grant Cameron et al to be some of the most important in this branch of the study of the UFO/ET phenomenon. Smith’s writings and reports cover:

- Sightings
- Alien Contact
- Free Energy Technology
- UFO/ Saucer pieces and analysis
- Investigation
- Viewing of Alien Bodies
- Anti-Gravity Technology
- Official Reticence (“Cover ups”)

Smith also realised that Metaphysics is important in understanding the phenomena (which few today speak of). He was way ahead of everyone else in understanding that it isn’t just a “nuts and bolts” phenomena of metallic craft flying through our skies and landing here.

Wilbert Smith left us an extremely valuable legacy – preserved by Arthur Bray, Grant Cameron, Nick Balaskas and others. I truly hope we can use it effectively.

8. More Contactees

An Overview

To make myself clear, I should state that in this chapter, I am mainly discussing figures who have stated that they have been in telepathic or conscious communication with ETs/aliens, but not abducted by them.

For some people, the contactee phenomenon is difficult to come to terms with. For others, it seems to be part of their everyday lives. “Mainstream” thinkers and sceptics may suggest the phenomenon consists mainly of “outlandish cults sucking people in to a belief system” – or something along these lines. Or, people getting involved in the contactee phenomenon may be described as just being messianic, or they have been “possessed” or become obsessed with a belief, about a catastrophe which is about to destroy us, or change life on Earth forever. If you read up on the many cases you will, no doubt, read about a fair number of (good and bad) prophecies which were hopelessly wrong.

Whilst a [summary of the activities of some of the 1950s contactees](#)²⁴² by [physics Professor W Rory Coker](#)²⁴³ includes some important and valid observations, it nevertheless shows a fairly typical bias in considering the accounts of some of the contactees and, in more than one case, ignores evidence and testimony from independent witnesses.

If we consider the evidence in a more patient and careful manner, can we conclude that it really is true that aliens or ET’s are giving people real information? Can their claims be corroborated? In the previous chapter, we covered the case of Wilbert Smith – a contactee who actually worked for the Canadian Government and was able to build hardware based on instructions given to him by “people from outside.” Everything I’ve found out about Smith suggests that he was just as he appeared – a good observer and a truthful, accurate reporter of fact.

Even when considering evidence in a balanced way, one of the many difficulties that people like me experience in embracing the contactees’ stories is consistency. Questions I ask myself might be:

- Are the stories given by contactees consistent with our own observations about the Solar System and our galaxy?
- Are the stories given by a contactee self-consistent?
- How consistent are the stories given between contactees? That is, if we agree they are really communicating with aliens from a particular group, do they give us information about other aliens which are consistent with information from other contactees?

It would be nice to give a contactee some of the photos or videos that have been deemed authentic (for example, ones from events discussed in chapter 6 or the ones from the 1993 Maslin Beach case in Australia, which I discussed in

“[Finding the Secret Space Programme.](#)”⁴²) We could ask them “So, whose ships are these, then?” To my knowledge, this has not been done or, if it has been done, the results have not been reported widely.

In the main, it seems that contactees talk to only one or two different groups of beings and their accounts don’t seem to contain much information about whether a given group of ET’s talks about any other group of ET’s and what they might be doing here. I must state, however, that I have not read every book written by every contactee. What I said, above, is based on listening to quite a few of them in interviews since about 2003.

Several common themes emerge in the different sets of contactee stories. Among them are:

- The ET’s are here as observers.
- The ET’s are here as guides.
- The ET’s are here to “upgrade” humans in some way.
- ET’s tell us that Human beings must “raise their consciousness.”
- ET’s tell us that human consciousness is evolving rapidly and we will start to function in “higher dimensions.”
- Human beings must become more aware of the environmental damage they (or other agencies) are causing and must work to “protect the earth.”
- Some ET’s were exiled here and have interfered with human development over centuries and even interbred with homo sapiens at various times.

One can certainly step back for a moment and consider how many alleged contactees there are – and it adds up to a considerable number of people. Are they all just misguided or dishonest or misunderstanding what they are experiencing?

A pattern that I have noticed (like quite a few other people, no doubt) is that the early contactee stories, particularly from the 1950s, seemed mainly to tell of benign sorts of beings who were our “space brothers.” It was only after the time of the Betty and Barney Hill case, in 1961, that the “bad alien” stories seemed to become more prevalent. Since then, the most often talked about type of alien seems to be the greys – who are involved in abducting humans to perform medical procedures or experiments on them.

But I am getting ahead of myself – we will look more at the abduction phenomenon in chapter 9.

George Adamski

Quite soon after the 1947 start of the “modern UFO/Flying Saucer” age, certain people came forward and claimed that they had met aliens. The most famous case, initially, was probably the [George Adamski case, who claimed to have been in contact with extra-terrestrials in the late 1940s and early 1950s.](#)²⁴⁴

His most famous encounter was in 1952, where he sighted a saucer landing and a being called Orthon emerged. Orthon was the pilot of a Venusian Scout ship, according to telepathic communications Adamski received from him. Adamski claimed repeated contacts with ET's and in the [book that he co-authored with Desmond Leslie, "Flying Saucers Have Landed"](#)²⁴⁵, published in 1953, Adamski claimed he had travelled in one of the craft. He described how he learned that there were several races of "space brothers" that he became aware of. Amazingly, he even produced a high-quality photograph of one of their craft. He said he had taken this through his telescope, using a Kodak box Brownie camera.

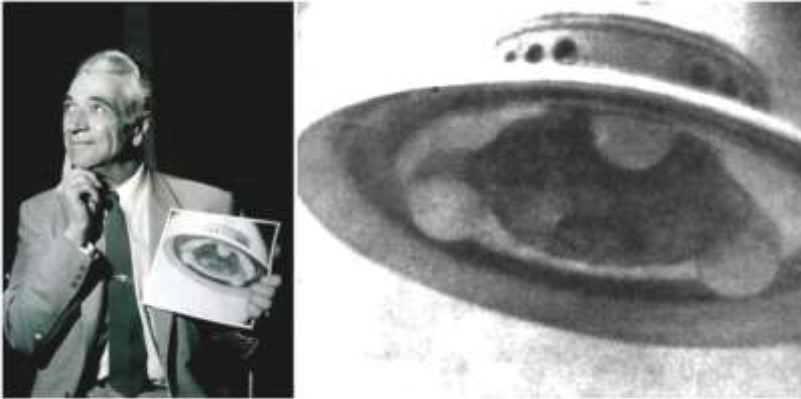

[Adamski and one of his most famous Saucer Photos.](#)²⁴⁶

Adamski became very famous, so it was perhaps easy to dismiss his story as a work of fiction, designed to bring him money and attention – which it did. However, as with all cases, [it is important to study the available evidence – even if it seems easy to dismiss the case as a money-making hoax](#)²⁴⁷. The Adamski foundation site seems to be a good starting point, where there are copies of letters from some people [who analysed the photos back in the 1950s and many of them agreed that they would be very difficult to fake.](#)²⁴⁴

However, even his co-author, [Desmond Leslie](#)²⁴⁸, was never quite sure how much of what Adamski said was true. While doing research into Wilbert Smith, I received a collection of files on CD from Canadian Researcher Grant Cameron. One file was [an article written by Leslie in January 1965 called "George Adamski - A Reassessment"](#)²⁴⁹ in which he wrote

After twelve years of close acquaintance with this extraordinary man I am still not very much wiser than when I first met him in California in 1954... He will undoubtedly go down as one of three things - the greatest charlatan of all time, a most original nut or one of the most important men since Elijah.

George is a maddening person. He will talk to you for hours on end, and you are just able to accept what he says as probable. Then, without batting an eyelid, he makes a statement so outrageous and patently impossible that you wish he hadn't said it. You go away disappointed in him. Then perhaps a few weeks, or days or months later you get independent confirmation that what he told you was the truth. For example, he arrived in London from Home a day or two before saintly Pope John died. I met him at the airport; it

was Whitsun weekend I believe and drove him straight to my little river cruiser at Staines where several of us had been spending the weekend.

He enjoyed himself and told us all about his trip. Later, for some reason the subject of gold came up and eventually George said: "Here's one piece of gold no one will ever take off me" and produced an exquisite little gold medal with Pope John's effigy on it. A medal which I checked later had not yet been released to anyone. I asked how he got it, and he answered, "John gave it to me yesterday". Knowing the Pope was at death's door and had had no visitors for a long time I was rather cross with him.

He then went on to tell us how he arrived at the Vatican according to the space People's instructions and was taken straight in, given a cassock, and led to John's bedside where he handed him a sealed package from the Brothers. On receiving it, John's face lit up and he said: "This is what I have been waiting for." He then had George presented with this very special medal and the audience ended.

Leslie then goes on to describe that Adamski did not know what was in the package that was given to the Pope. He also states that, to his surprise, he was able to corroborate Adamski's story through a lady he knew called Lou Zinstag. Leslie concludes the article, which was written following Adamski's death:

As to George himself - I think the world is richer for his coming and will be poorer for his going. It was he whose amazing pictures (pictures which have survived the test of time and critics) first really woke people up to what was going on; and I think that when the union of earth and the older races is complete (sometime within the next two thousand years) his name will be held in affection and: honour. Personally, I wouldn't have missed being his friend for anything.

Billy Eduard Albert Meyer



Billy Meyer is a Swiss Farmer, born in 1937, who claims to have been in contact with the Plejarans since 1945.²⁵⁰ His contacts continued over several decades and he allegedly photographed their ships hundreds of times, and recorded film and/or video of the craft flying near him. He also recorded the sound they make and he even photographed the occupants!

I will not discuss this case in detail, because from the research I have done, most of the Meyer information comes to us “second hand.” Several people including the late [Col Wendelle Stevens](#)²⁵¹, [George Green](#)²⁵² and more recently [Michael Horn](#)²⁵³ have been presenting the Meyer information in one form or another. To my knowledge, Meyer has not written any books, and neither is he “selling anything.” However, he seems to have a number of devoted followers (which isn’t proof of anything, of course!)

[A comprehensive website called “The Future of Mankind,”](#)²⁵⁴ whose domain name was registered on 27 Dec 2005, contains a large quantity of information from the Meyer case and discusses the complex set of claims and counter claims.

My general conclusion about the case is that he has had some type of contact with some type of extraterrestrial intelligence and some of the information, photos and videos are probably real/valid. However, so many people seem to have been involved with the case (for good and bad reasons), and because Meyer does not seem to have given many interviews, it is much more difficult to “learn where the truth ends and lies begin.”

Studying just the photos gives a good indication of what the case is like – some do look genuine, very clear and very intriguing. Others just look fake. Is it the case, then, that fake photos have been mixed in with the genuine ones?

[In regard to Meyer’s claims about having photographed the ET’s, this is exactly what has been claimed.](#)²⁵⁵

Howard Menger



Howard and Connie [Menger in the 1950s](#)²⁵⁶



“Venusian” reconnaissance craft hovers over field location No. 1. Polaroid photo by Menger.

Another significant case, with many witnesses, involved a sign painter called Howard Menger (1922 – 2009), who lived in a small town called High Bridge in New Jersey, USA. He was a WWII veteran and worked in Army Intelligence. He had a series of contacts, starting at the age of 10, and he said he saw saucers in the skies on more than one occasion, prior to 1956, when the contact experiences increased in significance.

Some may cry that the Menger story is simply a reworking of Adamski's accounts in a "me too" fashion. Menger, like Adamski, also claimed to meet Venusians. Further study, however, reveals there is much more to Menger's case. [In a documentary published in 1996²⁵⁷](#), he described some of his encounters:

In 1956, when the craft came in - these huge 40 to 50-foot craft - and they carried these beautiful angelic aliens and of course at first, I wasn't ready for any of this. No cameras - no recording equipment, no witnesses. But after that I prepared myself with cameras, witnesses - I had witnesses... I was taking a movie on one incident in 1956, Highbridge, New Jersey - where a craft was coming in. It's in my new book, "The Highbridge Incident." The pictures are in there and the craft is coming in and I'm taking a colored eight millimeter movie of this. I have several witnesses from the local area and also a federal agent from the Bureau in Newark, New Jersey. [He] was standing right next to me. I was filming a craft coming in.

The door opens, when it landed, and two men got out. One went to the left, one went to the right and then a beautiful lady got out - but she had a type of spacesuit on and she walked toward me and when she got about 25 or 30 feet from me, she didn't say a word. And she touched something shiny on her belt and that shiny thing got bigger and bigger and bigger, and finally enveloped her whole body - to where I could see her body as a light form. And then it disappeared and I was really, really surprised.

I yelled back at the craft - I said, "Where did she go? Where is she?" and they yelled back - in perfect Oxford English - "She's here with us in the ship..." So evidently, their technology has taken them into some type of teleportation ... our scientists have not approached that yet... So evidently, they have mastered time motion and energy in some way. Shortly after that, the two men went in[to] the craft, the door closed and it silently rose and left the area.

Menger was asked if he still has the original film. He responded:

I only have parts of it and slides I made from the original. The Federal Bureau of Investigation - the Bureau out of Newark New Jersey - took the original film.

Menger also reported that in another encounter, he was invited into their craft in August 1956, with a school friend he knew (but refused to name, even in the 1990s).

I remember getting in the craft - in the same location - we called it "Location 1" in Highbridge, New Jersey. They invited me in the craft and they didn't tell me right away where we were going, but I found myself in outer space - with a Polaroid camera. And there were about eight or nine people in there with me - aliens - and another man - a friend of mine from Highbridge, New Jersey ... We could see, through the portholes, the earth getting smaller and smaller and smaller. It looked like a blue tennis ball, with white clouds over it. Finally we could see the moon approaching - and getting larger and larger - through the portholes. I took pictures of the moon - on the other side of the moon - where there's a line between the light and the dark. There was like a small city there - and our government knows all of this. They know it all - but they're keeping it from the public.

Time is very difficult when you're flying in these aircraft. For instance, there's something I did notice on the moon trip. I thought it took ten days, but when I come back, I didn't have to shave, so that's less than eight hours so there's something here - in their technology about time. They're time travellers. As far as I know their technology is so advanced, we may never even have left the planet in a craft. We might have gotten in a craft and through their technology, contacted the moon section - and put it on a screen... and I thought... who knows? They're so far ahead of us...

Menger states in the video:

There is a definite government cover-up for three reasons political religious and scientific - and for national security.

It appears Menger had more knowledge about this than is immediately apparent. He stated that before the main landings and sightings, in 1951, he built a remote-controlled model saucer/craft, with some kind of electromagnetic propulsion system (no details were given). One day, he was flying this, but he lost control of it and it went out of sight. This was a blow, as he had built this craft over several years and had spent a few thousand dollars on the project. He reports that the craft was found, in a place which was over the Pennsylvania border several hundred miles from where he was. FBI agents came to his house, as they had traced him by working out where he bought the parts that the craft was constructed from. Though he was warned not to continue his work, he was later, in the 1960s, given work by the Pentagon. At that time, he was asked to go to work in Colorado Springs with a group of 80 scientists and engineers, developing his propulsion system (which allegedly used some form of anti-gravity). He then “disconnected” himself from the UFO community and worked in secrecy. The group he was working with, of course, feared that information might fall into the hands of the Soviets, hence Menger “kept quiet.” (Menger was interviewed in the video in the 1990s, after the end of the Cold War.) Menger said they built and flew a 50- or 60-foot craft.

Menger reported that the contacts with the “angelic beings” ended in 1958 and he was told that they visited “in cycles” and they would return in 2012 (but this was after Menger’s death).

The 1996 video, referenced above, includes interviews with several witnesses and other people who became involved with the Menger case. For example, a Psychiatrist called Dr Berthold Schwarz became interested after hearing Menger on local radio. He spoke to witnesses and interviewed several of them (though he did not witness events directly). He was convinced the events happened as Menger described and that Menger was totally honest.

Another local, Becky Gronsby stated that she had witnessed burn marks on the ground, in the field where Menger said the saucer had landed.

Richard Harpster, a local reporter, knew Menger and his family and he stated that he went to see Menger, with two friends who were members of the State Police force. Harpster, who described Menger as a kind, calm, quiet and thoughtful man, reported that he didn’t see anything:

We went to visit Howard and he said, "Oh yeah, they're up there." And he showed us some photographs he had made of flying saucers and he asked us if we would like to meet these people from outer space. And of course, we said "yes" so he took us up to a field up on top of the mountain and said they'd be there about 11 o'clock at night. And we just had to wait - and needless to say, we waited and waited, and nobody ever showed up.

Howard later told me that one of those guys that was with me was carrying a gun. I said, "Howard all those guys were carrying - they were all State Policemen."

Another witness to certain events was Wayne Hutchin, who was 16 at the time.

Well one evening, [Howard Menger] advised me that there would be a sighting, he believed, so I took a girl I was dating at the time. Her name was Dorothy ... and a friend who worked for my father - his name was Richard Berry and he was repairing televisions for my father. He was a student I think, at Princeton at the time. I couldn't drive - I didn't have a license at the time, so Richard drove Dorothy and myself down there and we met at Howard's house. Sat in his kitchen - had Coco, as I recall. And he said "Let's go up into the woods and we'll see if..." He said, "I think the ships are here." So we did - and it was Howard, his wife Rose, his sister-in-law Mary - who I think was single at the time - myself, Dorothy and Mr. Berry.

We broke up into groups. Howard - and two of the women went one way and myself and Mr. Berry and Dorothy went another way. We walked down this wood trail and we did see these pulsating lights in a ravine, on the ground - and these were ... he said, they were Scout Ships and they seem to be translucent - like you could see through them and they seemed to have a bright - brighter cores inside like a vacuum - like a light bulb, or a vacuum tube. And they would change colors. They'd be pink and then they'd be green and then they'd be whites - and whatever. They just kind of seemed to hover over the ground.

One of them did seem to put out a little light, which kind of went round us, I think and then went back in again. We were awestruck - there's no doubt about that. Remember, I'm 16 years old and never saw anything like this in my life! And I believed everything that we saw was, in fact, out of this world.

Hutchin continued:

So we went back down to his house and he said, "I think one of the alien people trusts this group and they're going to make themselves visible." So we went out and stood in his backyard and in the lawn area - and it goes up to a hillside. It was in meadows. And within a short period of time Howard says, "Look here comes one now!" and it was this kind of ghostly apparition of a human figure - which kind of floated across the meadow. I remember he kind of went over a fence - kind of just floated over a barbed wire fence - and came near to us, but not that near that you could distinguish any features - I'm talking maybe several hundred feet. And then he faded away back into the woodland and that was it - and we went back to the house and we were just like "Wow! Greatest thing that ever was!"

Another witness was Connie Michelles (or Mitchel), a journalist who came into contact with Menger when she became interested in the case - she then fell in love and married Howard Menger in 1958. She had her own first UFO encounter one evening shortly after. In the video she describes:

We were coming home from the grocery shopping and as we came up on the hill on the farm, we parked the car against the fence and there was a big luminous pearl-like spherical shape right above the trees over the next field. And Howard stopped and he said, "Look!" and I said, "Oh wait, I've got to get my camera!" By the time I got to the station wagon, turned around and got the camera, it was gone...

When we were on our honeymoon in Las Vegas, we saw the same pearl like iridescent glowing/globular disc...

One more time - but this - this really gets me. It was on our farm and we were there - our attorney was with us - and we had heard that some people at Whitehouse - they were having a game - and they had seen discs flying over the stadium. So we went out to the field and looked upward - and sure enough there was a fleet of discs flying overhead. Our attorney turned to me and said, "Connie this is for you," and one of the discs tipped - just like that - and that was that.

Connie reported that this last incident happened in the week she learned she was pregnant with their first child. She also reported that they made a lot of sacrifices in speaking the truth about their experiences and they lost their home and Menger lost a lot of his business.

Of course, reading an article about Menger on a site like "How Stuff Works" may lead you to quickly dismiss the case and wonder why it was ever taken seriously.²⁵⁸ For example, the article states:

*After releasing a book, [From Outer Space to You \(1959\)](#),²⁵⁹ and a record album, *Music from Another Planet*, Menger would virtually recant his story, vaguely muttering about a CIA experiment. In the late 1980s he withdrew his recantation and marketed a new book detailing his latest cosmic adventures.*

The article above does not name any other witnesses who have gone on record, as having shared some of Menger's encounters and experiences. It is also lazy with regard to the facts of what Menger's understanding was, about the origin of the people he encountered. In the 1996 video he states:

I asked them once, "Well, where did you come from? and they said, "We have just come from the planet you call Venus." Well, that doesn't mean they're Venusians - they're travellers. They might have a base there...

So who is to say where they come from? The one thing I'm almost sure [about is that] they don't come from this planet and they're way ahead of us in political, scientific and religious understanding.

I asked them "Why are you here? Are you here to heal people or solve all our problems... and blah blah... all this... He said, "No - it is against our universal laws to interfere in any civilization which we descend upon. Your record - your history shows that that you advanced civilizations have advanced on lower civilizations and they've destroyed them.

They've been here thousands of years ago when there were oceans where there is now land and where there was then land, there are now oceans.

And when they come back, the civilizations have gone down - disappeared... Like Atlantis and some of the others. They come back to check on us. They are our ancestors. They helped us to rise up from Homo sapiens to where we are now - to a thinking human being, who can make

tools and who invent technological things to help humans and live a better life. They said that they have laid down laws thousands of years ago - most of them are in our scriptures today - various Bibles all over the world - holy books all over the world...

In the 1996 video, Howard and Connie Menger both discuss how the ET contacts are meant to inform us of our true place in history – i.e. that they are our ancestors, or relatives. Connie accurately states that vested interests control the planet and will not simply allow change. The ET's realise that creating conflict would be counterproductive, so if change is to happen, it will be at a very slow rate.

Howard Menger concludes:

One reason they're here - is for a spiritual reason - to develop... it's more on a spiritual level. Technology is advancing quicker - and going further ahead - than our spirituality and that's very dangerous.

Also featured in the video is Glenn Steckling, of the Adamski foundation, who adds to Menger's words, echoing what many other contactees have said.

Personally, I feel that we have to have a greater reverence for life - all life... greater respect for our planet, greater expression of intelligence between each other and greater care and responsibility for everything that we do. We have to take responsibility and take charge for what is happening today, because that is the only way we can change it and once we do these things, we become - I wouldn't like to use the word "worthy..." We become more receptive to contacts with other people...

Sixto Paz Wells

In about 2004 or 2005, I became aware of the case of Sixto Paz Wells, a Peruvian Contactee, thanks to a lady called Joanne Summerscales, who had lent some of her support to one of Sixto's UK lectures. [He has written 20 books](#)²⁶⁰ (only some have been translated into English).



[Sixto Paz Wells](#)²⁶¹ was born in Lima, Perú on December the 12th, 1955. He is married and has two children. His father had researched the UFO subject, as a hobby, in the 50s and he had taken an interest in Project Blue book. Sixto's father founded a research institute called IPRI or Instituto Peruano de Relaciones

Interplanetarias). In an [interview conducted in 2013 by Oscar Magosci](#)⁹⁹, Sixto stated:

My father taught me, together with my siblings, not just to believe but to think in the possibility that in our vast universe it would be strange not to have life other than on Earth, rather than the opposite.

It seems the start of his contact experiences were initially triggered due to newspaper coverage of something called [Project Ozma](#)²⁶² – a small-scale SETI programme - which was directed by Frank Drake (who we mentioned in

chapter 3) in the 1960s. This motivated Sixto's father don Carlos Paz García, to organize a conference to discuss some of the issues brought up by the article. His father enlisted the help of Dr Víctor Yañez Aguirre, from Lima's Hospital de Policía. Aguirre was, apparently, an esotericist – who was very interested in parapsychology. Aguirre had written about the possibility of telepathic communication with alleged interplanetary visitors.

Sixto stated that the conference inspired his own interest in experimenting with telepathy – a process that he felt might be assisted by his practicing of Yoga, which he had already been practicing for about a year, with his mother and his sister. They continued sessions of meditation then, on the night of 22 January 1974, during meditation, they received a psychographic (pictorial) message, and Sixto stressed they were not in a trance. The message was:

This home's living room is adequate for communication. My name is Oxalc and I'm from Morlen, which you call Ganymede, one of the moons of Jupiter. We can have contact with you. You will see us soon.

Even though the three of them received the same message, Sixto first wondered if it was all just part of their imagination. The following day, they tried to arrange themselves to receive another message. This time, they got a group of 20 people together. They received a message and, pressing for some indication that this was a real message, they were told that on February 7 they should go to the desert of Chilca, some 60 km south of Lima. In the Oscar Magosci interview, Sixto stated:

The people were gathered in that place, all of them were sceptical and, at the exact time, a strange and intense glow appeared behind the hills. For a few seconds the night became bright as day and, suddenly, from behind the hills, a light showed up and began traveling above the ridges, becoming stationary on the right side of the horizon. From there it began swinging, approaching and descending, producing great fear in the group. The light gradually transformed itself into a metallic disc-shaped object that rotated upon itself and had half a dozen small windows and lateral colored lights. Once it was on top of the group, it projected a light as if it was noon time and this light was sustained for several minutes that never seemed to end.

Then we all felt something akin to a mental message that told us that they "didn't come down in that moment because the group didn't know how to control its emotions." The message said that further on "there will be a time and a place." After this, the object began to move and left at a great rate of speed. The group was visibly shaken.

Sixto explained that over the next month, eight people (both men and women) continued to receive messages from Oxalc and other male and female extraterrestrial beings named "Kulba, Xanxa, Sampiac, Anitac, Meth, Lertrad." Sometime later, Sixto invited his father and some of his friends to go to another location, to partake in a similar "verification" exercise. When they got there, they had a sighting of a cylinder that they estimated to be 150 meters in diameter, at an altitude of about 3000 feet. They continued to witness objects in the Chilca area for the next few months – both during daytime and night time. Objects flew in formation and even divided up into smaller objects.

The number of people involved in the activities increased again over the next few months and by June 1974, perhaps as many as 60 people were involved. The communications with the “other beings” continued to the point where they were invited to make physical contact.

Sixto recounts that they split into groups of seven and, on one occasion in June 1974, he was walking slightly ahead of his group when he suddenly seemed to be transported some distance, behind a hill, where he saw a “half-dome” shape, about 10 meters or 30 feet in diameter. A humanoid silhouette stepped out of the illuminated dome and beckoned to him, three times, to approach and go into the light. Sixto said he was afraid, but as the being went into the light, Sixto followed. The being was about six feet tall and had a wide oriental face and thin hair. The being was dressed in a kind of shiny leotard. Sixto communicated with the being telepathically as it gestured with its hands. He was told the phenomenon was a “Xendra” – which was a space-time dimensional doorway. This was made by “concentrating energy in a certain way” and the Xendra then allowed teleportation. He was told they would go to Morlen, one of the moons of Jupiter (actually Ganymede), which was nearly 400 million miles away. He was told that time would pass more quickly on Ganymede, compared to Earth.

Sixto said he remained on Ganymede for about five days, whilst only 15 minutes passed on earth, as he discovered when he got back. While he was there, he saw a Crystal City with spherical buildings, and everything had curved edges. He saw men, women and children. The environment was completely artificial – the beings had created a micro-climate and a small atmosphere for their cities. The beings, Sixto said, came from the Orion Nebula and were clairvoyant and communicated telepathically (as he’d already established!)

As Sixto points out, in about 1996 or 1997, the [Galileo Probe studied Ganymede and it detected a magnetosphere and Ozone](#)²⁶³. However, it was almost certainly too far away to photograph the moon in sufficient detail to show any structures like the ones he described, although some have claimed that a domed structure was found on a [NASA Image of Ganymede PIA01090 \(see below\)](#)²⁶⁴. Others have claimed to see even more features on this image, but I have not studied these claims in detail.

Sixto reported that on April 25, 1977, a Chilean corporal, Don Armando Valdéz from the Rancagua regiment, was patrolling together with other soldiers in the northern area of Putre, Arica. Valdéz observed a light above a hill and asked the soldiers to “cover” him as he went to see what it was. He went (into the light) by himself. Fifteen minutes later, he came out with a five-day old beard and his watch showed that five days had elapsed. He seemed to have undergone an identical experience to Sixto’s, but Valdéz couldn’t remember what had happened when he was inside the light.

Unlike Adamski, Sixto invited journalists and other people to come and get involved in his activities. One such journalist was Spanish reporter Juan José Benitez who was a regular press correspondent for the Spanish news agency

Agencia EFE. He was sent to Perú to cover the strange news emerging about the activities of Sixto's group. Benitez life changed completely when he became a direct witness of those contacts. He was with the group in the Chilca desert on September 7, 1974 when he saw two UFOs, just as he had been told that they would. This made a big impression on him and he went to recount his experiences in the (European) Spanish press and on TV.

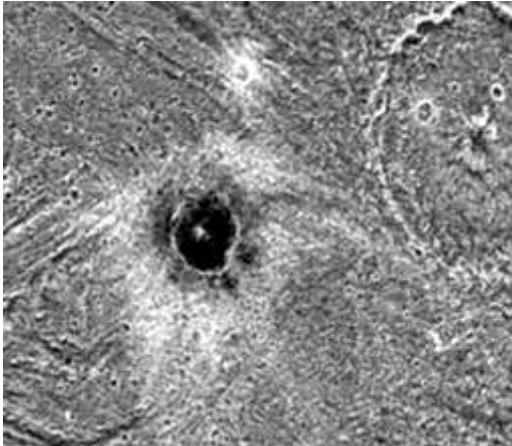

NASA Image of Ganymede PIA01090²⁶⁴

He then wrote a book called "OVNIS S.O.S. a la Humanidad" published by Plaza & Janés. The following year, Benitez went back to Perú along with Manuel Mujica, another reporter from Agencia EFE.

Again, with Sixto's group, they had a sighting at a pre-arranged time and place - on a beach north of Lima.

Following this, Benitez published another book "Cien

Mil Kilómetros Tras los Extraterrestres."

Sixto reported that these encounters were followed up with other groups getting involved. 40 reporters from eight countries came to the desert location, including José Gray from Channel 23 Univisión (Miami), Leticia Callava from Telemundo, Beatriz Parga from the Miami Herald, Gilda Muñoz from Radio Guado in New York, Rolando Veras from Channel 2 in Buenos Aires, Argentina, Lizet Zelman from Televisión de República Dominicana. Others also witnessed the striking ongoing reality of the contacts.

Sixto has since done presentations to groups around the world. In the Oscar Magosci interview, Sixto stated:

It is convenient for the governments of the great powers to hide the reality of the UFO phenomenon and the existence of extraterrestrial life because for the armed forces, it's equally valid whether UFOs are from extraterrestrials or from foreign countries. From the moment that an unidentified flying object challenges the air space of a country, without anyone being able to do something about it, it is a national security problem. Before taxpayers they would be facing ridicule. On the other hand, the most profitable business today, even one that challenges drug dealing, is arm sales. The most developed countries are manufacturers and sellers of armament and if there weren't wars, they would have to invent them for the business to go on.

At another point in the interview he rightly states:

Let's remember the case of the (first) War in the Persian Gulf. It was the most advertised war in history, but no one found out what really took place there. If they could hide (the truth about) a war and isolate a vast area of the planet, what couldn't they be doing regarding some concepts that are uncomfortable to their interests?

This is, of course, exactly what has been happening – following the dustification of the WTC on 9/11. This was successfully covered up, while several other related manufactured conflicts in the Middle-East were planned and initiated. Sixto reports:

Most of these beings don't come with bad intentions or they would have already liquidated us a long time ago, this would force us to unite as one great nation. It would be better if the space beings met us united rather than in conflict with each other, but if borders were to disappear arm sales would finish since there wouldn't be any demand for it. Without borders there wouldn't be foreign debt which is a mechanism to oppress people. Also, smuggling would end and political elites would diminish.

If the reality of the extraterrestrial presence is made known, it would also bring an economic crisis, as well as a crisis of faith because religions would have to explain the reason they have been silent on this subject since they affirm that they are provided with revelations from above.

As we see, in order to understand the UFO subject we also need to understand the kind of world we live in...

Sixto stated that “Scientists are at the service of the capital that finances them.” He therefore understands, I would say, why mainstream science will not “give us the truth” or embrace the available evidence. This is exactly why “limited hangout” programmes like SETI exist.

Sixto said that the primary message or mission of the beings he encountered was to tell us about the risks to our future if things continued to operate in a certain manner here on earth.

Out of a greenish, bright screen, suspended in the midst of the air and inside a building with the shape of a truncated cone, Oxalc showed me a series of images of what the future of the Earth could be like. What I could see is that the world's tension was such that it was attracting the perilous possibility that an asteroid or comet would pass so close that it could be affected gravitationally. The purpose of this journey was to alert others, through young people willing to commit themselves with the message about the need to change, beginning from within each individual in order to generate a chain reaction that would revert the planetary future.

According to the extraterrestrials, since the future is due to cause and effect, the prophecies have not been given so that they come to happen but so that they do not. They exist to alert in order to correct. The future is not unmovable since, otherwise, where would our free will be? On the other hand, regarding positive prophecies, we must cooperate so that they come to pass.

The human mind is powerful and if many of us agree with the same intention and with faith, we can make it. But what is important is to change our attitude before life. We must be more optimistic, positive and constructive...

... This change must take place now, but it all begins in us and with us. Then, it continues with each one's family and so on in the manner of a chain reaction of Domino blocks falling down one after the other.

Asked about how he wants to be perceived by people, Sixto replied:

I'm not interested in convincing people, only to make them think and motivate them to expand their minds. I know that what we have gone through is real and we have been able to demonstrate it more than once. For this reason, I have the authority to disseminate something I consider valuable and useful, especially in times such as these.

Archons, Solar Flares, Hurricanes and the Galactic Superwave

In researching Sixto's case, I came across a new interview with Sixto – which was posted on YouTube only one day prior to my looking for information. The [interview was posted in Oct 2018 and was hosted by Alan Steinfeld](#)²⁶⁵.

The interview is rather disjointed and Steinfeld perhaps understandably gets excited and keeps changing the subject. However, quite a few interesting things emerge in the interview.

Sixto mentions that there are 60 different races coming to the earth and more than 38 ships have crashed here – some of them have actually been brought down by groups that are “watching over us.” He said that a group of “bad guys” (the translator's phrase) were deported to earth long ago and they were trapped and later died here. The name “archons” is mentioned here and it is said we have been “psychically manipulated” by this group.

Sixto reports that Solar Flares in 2012 could have been catastrophic to us but a collective conscious effort was able to change the outcome. He gives the dates of 5 and 6 March 2012. It is indeed true that [large flares were reported on 5th March](#)²⁶⁶, but they were said to be of no real risk. However, about 4 months later, it was said we had a [lucky escape from a solar storm and CME \(Coronal Mass Ejection\)](#).²⁶⁷

Sixto also stated that Hurricane Patricia was expected to cause much more destruction as [it had the highest recorded wind speed of any hurricane](#)²⁶⁸, but because there was a conscious effort by a group of people, the wind speeds were much reduced. [It was indeed the case that the storm diminished in strength considerably, after first making landfall.](#)²⁶⁹

Sixto also discussed how, every 26,000 years, a pulse of energy travels out from the centre of the galaxy and when it reaches our solar system, it creates mutations. It is implied that about 26,000 years have now elapsed since this happened previously. (That is, we are therefore due to experience another pulse of energy from the centre of the galaxy.)

It is not clear whether Sixto is quoting the research of [Paul La Violette \(PLV\) who, over the last 30-40 years, has written extensively about the so-called “Galactic Superwave” phenomenon.](#)²⁷⁰ PLV also suggests a 26,000 year periodicity, but states it could be shorter than this.

An Invitation

In year 2000, Sixto's book, “The Invitation” was published in English.²⁷¹ I have not been able to read it, however, so have looked [at one of the Amazon reviews](#)²⁷² which seemed to give an honest account of the content of the

book. Titled “Reads like the truth, no sensationalism, no bombastic ego,” the review states:

This book reads like the real thing...The author simply extends an invitation (as the title says) to step out of our self-imposed limited view of the universe and explore our spirituality. Yes, spirituality. This book is all about explaining not only the history of how Paz Wells came to contact (often through telepathy) what he believes are beings from other planets, but much more importantly, the trials and tribulations he and others had, while coming to understand through their practices and experiences that the beings they were in contact with were contacting them - not for the sake of contact itself, but to assist the human race in its spiritual evolution.... Wide-eyed expressions of ‘Wow, they are real!’ are not the core of this book, such emotions are only mentioned in passing ... “The Invitation” is not all sweetness and light. Paz Wells describes in detail the challenges his group faced (including his own ego and pride) as they attempted to deepen their contact with what he believes are ETs (extraterrestrials), and then follow their instructions. Warts and all, he describes personal attacks in newspapers, legal battles, as well as dissension and discord in the group as it tried to spread the messages from those who he says were contacting them. He also describes scary visions of negative entities that attempted to physically imperil their work and wonders openly at one point if the beings he believes contacted him, were playing a joke. He is not a wild-eyed “I-want-to-believe” kind of person.

While this book will challenge your belief system, it does not come across as gloom-and-doom, or fluffy bubble-gum for the mind. There is also little in the way of ego on the part of the author ... There is no address of an organization to join, no website, no videotapes or anything else offered for sale, all things one would expect of someone trying to earn money through sensationalism. All in all, it comes across as what it purports to be, factual descriptions of encounters with extraterrestrial beings who are contacting humanity to assist us with our spiritual evolution.

Dr George King and the Aetherius Society



Dr George King (1929-1997), a former taxi driver, did not claim to have experienced direct physical contact with ET's, as Adamski, Menger and Paz Wells had. The picture he described was subtly different. In common with other contactees, King had a calm and often unassuming demeanour. [In a frank interview, conducted in a BBC “Lifeline” TV programme on 21 May 1959,](#)²⁷³ King stated:

I had quite an amazing experience one Saturday morning while I was washing up some dishes. I heard a voice - quite definitely a voice out of this world - say to me “Prepare yourself - you are to become the voice of interplanetary Parliament.” Soon after this, I had a physical visitation from a member of the cosmic hierarchy, if you like, who gave me certain instructions. I obeyed these instructions to the letter and later on, I found I could contact intelligences from other planets.

He went on to describe the physical visitation:

I was sat in a room and a man walked through a locked door across the

carpet on the floor and he was quite physical when he crossed the boards. They creaked - and he sat down opposite to me and began to talk to me...

He was as physical as you [the interviewer] are now... He is a man who is living in northern India at the moment, but he came from another planet - I believe it was Venus... He would have been taken for an Indian I think... This was a special body he used when he was on this earth.

The interviewers asked King to describe the instructions given to him by the man, but King stated he is unable to do this (though he does not give a reason). King then stated he was given a title, by the “space people,” of “Mental Channel Number One” and he was then able to channel messages from them. King stated his reason for founding the Aetherius Society, thus:

I wanted to make known this great truth that I was receiving. I wanted all the world to know about it so I founded the Aetherius Society so that this could be brought about.

Asked by the interviewer “How do you know that this is not, in fact, a projection of your own imagination?”

King responded:

Because I've met these people. My mother has met physically one of the people who has been speaking through me for a number of years and he told my mother this fact - that he has been speaking, virtually, through me.

Also, of note, in the interview is that they play a short portion of a recording made by King’s mother where she describes part of her trip in a flying saucer. King reports:

I'd like to point out that my mother has travelled in one of these vehicles in a physical body and she went along to a meeting that was arranged... and she had to walk through mud in a field and she got her shoes covered with mud. She walked up some steps and into a flying saucer...

King stated, when asked, that he had met people from Saturn, Mars and Venus and he described the man he met from Saturn thus:

The particular person I met was a man he was average height, dark hair - fairly broad-ish. He had no pupils to the eyes, very, very large hands but very, very small feet.

In the BBC interview King puts on a blindfold and enters a trance and during this segment, the anonymous interviewer asks what single message King (Aetherius) would like to give to the audience. King, while channelling Aetherius in a distinctly different voice, with a markedly different English accent, states:

I would like to say this. If you are Christian, then live the laws as laid down by Jesus. If you are a Buddhist live by the laws as laid down by Buddha. If you are a Hindu, then be the best Hindu. This... procedure is the one true way for men of earth to save themselves from their lower aspects.

In the BBC interview, following the main interview, two scientist commentators, one of whom was Jungian Psychiatrist Dr D.W. Dewhurst are fairly respectful, though rather dismissive of King, who was not given time to respond to their points directly.

The Aetherius Society²⁷⁴, still in existence in 2018, was named after the being that George King said he was in communication with. On their website, the following is stated:

...the Society's beliefs encompass many different subjects, including:

- Oneness and the Divine Spark within all life; God is all
- UFOs and advanced life on other planets
- Prayer as a natural way of invoking and radiating spiritual energy
- Karma and reincarnation
- Yoga philosophy and practice, including yoga breathing and the chanting of mantra
- Kundalini, chakras and auras
- Spiritual energy and spiritual healing
- Psychic powers and intuition
- Enlightenment and cosmic consciousness
- The Mother Earth as a living Goddess
- Holy mountains
- Life at other frequencies of vibration, which are also known as other "planes" or "realms"
- Ascended Masters

The Society does not regard itself as the one and only path to enlightenment or salvation. It maintains that all the great religions are simply different expressions of the one essential timeless reality that is the Divine Source.

I might add that I have met several members of the society and they are clearly kind, decent, honest people. Also, their activities are, from everything I have observed, laudable and utterly benign and altruistic. One of the interesting inventions which the Aetherius Society claims to have developed is a "Prayer Battery," [described in one of the Society's videos](#),²⁷⁵ thus

In Operation Prayer Power, by means of physical radionic apparatus devised by Dr King, prayer energy is stored and then released at times of crisis in the world to relieve suffering and restore balance. Operation Prayer Power has been taking place since 1973 and is open to all people who believe in the power of prayer and have a sincere desire to heal and uplift our world.

It seems to be true that organisations like the Aetherius Society are definitely of interest to the Intelligence Agencies. This was discussed in a (very biased and rather derogatory) article published in the online edition of the UK Daily Express Newspaper on 28 Jul 2015. The article states that agencies:

... suspected that his bizarre antics were all part of a Communist plot to overthrow democracy and stop Britain becoming a nuclear power. Top secret files reveal that police launched their probe after the now defunct Empire News newspaper picked up King's anti-nuclear rhetoric and linked his UFO society to Moscow. The paper handed over copies of the society's Cosmic Voice newsletter to detectives, in which the cult leader wrote that aliens had appealed to him to stop nuclear experimentation.

We can at this point note that the 1950s contactee phenomenon often had an "anti-nuclear" stance, or, more broadly, a stance of encouraging and promoting world peace and good will to all. Whatever the reality of contacts with ET's – physical, telepathic or both, it is true that many, or even most, groups that promoted values of peace, tolerance and co-operation were

monitored and even infiltrated by those working for the Military Industrial Powers that have dominated our planet since the end of World War II.

James Gilliland and ECETI

James Gilliland who has a ranch with views of Mount Adams, at Trout Lake, Washington, USA, has been discussing the alien/ET/UFO issue since at least 2001. A description on his website reads:

James Gilliland is a best-selling author, internationally known lecturer, minister, counselor, multiple Near-Death Experiencer and contactee. James is recognized world-wide as the founder of the Gilliland Estate, previously referred to and commonly known as the ECETI Ranch (Enlightened Contact with ExtraTerrestrial Intelligence) where he documents and shares amazing multi-dimensional contact phenomenon.

Some years ago, he wrote a book called “Reunion with Source,” the description of which states:²⁷⁶

After a near-death experience in 1979, James Gilliland opened to interdimensional reality and met Cazekiel, better known as Ezekiel in biblical days. Together James and Cazekiel prophesied the 1994 collision of comets with Jupiter, followed by escalating earth changes.

A page on his website states²⁷⁷:

The people of Earth are being offered a chance to join the rest of the universe in peace. The technologies to end disease, clean up and restore the environment, fuel-less energy technologies, and the virtual keys to Utopia have been disseminated and are waiting for distribution and production. A whole new world is unfolding for those with the courage to accept it. CE-5 Contact with spiritually and technologically advanced extra and ultra-terrestrial off world visitors which we refer to as the greater family of man has occurred at the home of James Gilliland, known as the ECETI Ranch.

Here again, Gilliland echoes similar themes as other contactees. Gilliland does not claim to have had physical encounters with beings, but he organises regular night-time sky watch observing sessions and employs Nightvision equipment to help people see (what could be) craft manoeuvring in the sky.²⁷⁸ Some of these videos may just show satellites and one video almost certainly shows a bird (you can see the wing flapping in the slow-motion segment).²⁷⁹

When I first discovered Gilliland’s site in about 2003 or 2004, I thought that a clip he recorded,²⁸⁰ which he called “Bethlehem Ship”²⁸¹ was very interesting, but some would claim he had just filmed an Iridium Flare²⁸², although this would be quite a lucky event – as these are quite rare and you have to be in a particular place at a particular time to see them. That particular clip only seems to be in the Internet Archive now and I couldn’t find it on the main site (even though I think it’s more interesting than some of his later videos).

As is common on many similar sites, there are no obvious links to other UFO/ET related videos or evidence– such as the NASA shuttle footage – discussed earlier in this book – or anything else I have discussed in this book.

Dr Steven Greer and CSETI

According to Dr Steven Greer, his “Disclosure Project” was part of [a larger initiative he called “CSETI”](#)²⁸³:

The Center for the Study of Extraterrestrial Intelligence (CSETI) is an international scientific research and education organization dedicated to the furtherance of our understanding of extraterrestrial intelligence. CSETI was founded in 1990 by Dr Steven M. Greer, who is the International Director. CSETI's projects include the CE-5 Initiative, and the Disclosure Project.

[Greer characterises CE-5](#)²⁸⁴ as “a two-way communication with ET’s, initiated by humans.” [The website further states](#)²⁸⁵:

CSETI is committed to the thoughtful long-term development of bilateral ETI-Human communication and exchange, and open public education on the subject. We regard this endeavor as the most important scientific and educational project of the next thousand years and invite you to join us.

Though I find this approach appealing, and Greer has posted some very interesting information about the CSETI “protocols” and techniques that he has allegedly developed – such as “coherent thought sequencing,” I have very strong reservations about him and some of his statements and activities, as I discussed in chapter 6 of [“9/11 Holding the Truth.”](#)²⁸⁶ We will study other problematic areas of Greer’s statements and activities in chapter 23.

What is perhaps most interesting, however, is that quite a few people that have [followed Greer’s methods \(included in an App for Android and iPhone\) have reported positive results – in the form of sightings \(normally at night\) of objects of one kind or another.](#)²⁸⁷ Others have reported failure and obviously don’t trust Greer.

A friend of mine did his own experiments in about 2004 and reported that a brilliant light appeared and hovered near his house – and this was in a built-up area, in England!

None of the CSETI related accounts I’ve read discuss craft actually landing, nor do they discuss physically meeting ET beings. I myself have not devoted much time to trying the methods, having only had a short attempt with a friend, in about 2005. I have not practiced meditation and find such activities quite difficult, as my mind is more often occupied with one thing and another. Also, it is true that people involved in the CSETI group itself have had their own disagreements – perhaps because group members have also noted the sorts of things we will discuss later.

“Starseeds”

There are a number of other movements and websites which follow similar themes to the Aetherius Society and aim, in one way or another, [to connect us with enlightened extraterrestrials](#)²⁸⁸, as a way of joining with the larger “cosmic community” (or whatever description seems comfortable for you). It really would not surprise me that there are “Star Nations” out there – but I have come to the conclusion that there are both benign and malevolent forces, just

was we find here in human affairs. Hence, we still need to exercise care and discernment in building any relationships – particularly in view of how difficult it is to get reliable information about off-world beings, races and groups.

Conclusions

The contactee phenomenon is complex – involving elements of psychology, religion, technology and in some cases, it appears contactees may have exaggerated or embellished their claims. However, in the cases I have covered in this chapter, I would not feel as comfortable as some people do in characterising the people involved as liars or frauds. In studying available information and evidence, it appears that the (alleged) contactee that is most interested in self-promotion and money-making is Dr Steven Greer. The main goal of the other contactees I discussed, as far as I can tell, seemed to be to convey a “spiritual message,” in an effort to encourage us to “think bigger” and consider the effects of our actions in a wider sense.

Interestingly, as Professor Rory Corker observes, there seem to be some common themes between what George Adamski, Dr George King and Billy Meyer said – and they are themes echoed, specifically, in the Theosophical Teachings of Madam Blavatsky – referring to “ascended masters.” This is not to say that such teachings are “wrong” or “crazy” – but the parallels are worth noting – especially when each of these sources do not quote each other directly. Similarly, most contactees and channellers make no reference to other contactees or channellers and rarely – or perhaps never - do they make reference to other evidence, such as that discussed in this book. This always strikes me as somewhat peculiar, as it would add to their credibility of having accurate information about a given incident. For example, I have never heard a contactee or channeller point out that NASA’s claimed Apollo moon landings were a hoax. Similarly, none seem to have spoken openly about their knowledge of events before and after 11 September 2001 or how any ET’s might be interested in those events. Now that we know the WTC towers were destroyed using advanced technology (as I have discussed elsewhere), could we not make the suggestion that ET’s would be interested in this situation? Wouldn’t they show a similar interest to the apparent interest they have shown in the development of nuclear weapons and nuclear power? Why wouldn’t this sort of message come out through contactees?

Whilst it’s hard to sum everything up in a few lines, I hope that in this chapter, I have demonstrated that the contactee phenomenon should be taken seriously – as there is significant evidence to suggest that some people have been contacted by some ET’s and, in general, given positive messages.

9. Abductions and Abductees

An Overview

It seems clear that we can consider the abductee phenomenon as another “branch” of the contactee phenomenon – with the distinction being that the person concerned is taken against their will.

Starting with the simple observation that “there are good and bad people in the world,” we can simply extend that and suggest “there are good and bad ET’s in the galaxy/cosmos.” Most people won’t ever consider the question, “if we developed advanced technology that allowed us to travel to the stars, would we develop advanced ethical practices and thereby live an enlightened existence?” Would we respect the sovereign rights of all conscious beings? Would some of us try to suppress or oppress others in order to assert our will? These sorts of themes have been “played out” in science fiction and science fantasy books and TV shows etc and this book attempts to work through evidence, rather than spend too much time pontificating or being philosophical.

Some speakers and researchers want to claim that there are no “negative” or “evil” ET’s because “cosmic law” restricts their activities in a way that does not permit them to interfere with affairs on other planets. Maybe this is true – and, indeed, I have already mentioned my thoughts on Wilbert Smith’s discussion relating to this idea, in chapter 7. Hence, some people conclude that all the ET’s that come here must be “enlightened and benevolent.” That is to say that the only negative entities in the vicinity of planet earth are “us humans...”

This is rather simplistic logic and if we treat the evidence and accounts on a “level playing field,” it seems we have “good and bad ET’s/aliens” interacting with us and some of them have harmed people. Of course, we haven’t experienced an “Independence Day” or “War of the Worlds” style invasion or conflict, but one can certainly argue that we are – and have been for many years – right in the middle of another type of war. To use Dr Leonard Horowitz’s phrase, this could be described as a “bio-spiritual war.”

From what I have read and listened to, a high proportion of abductees report what I would say are “negative actions.” It tends to play out thus:

- Seeing a craft of some kind, usually at night
- Being either indoors, having gone to bed, or be out driving somewhere.
- A blinding light or beam is often seen for a short period of time.
- They experience a sensation of being lifted up or levitated.
- They find themselves laid on a table or bed of some kind, with one or more items of their clothing having been removed.

- Beings (normally the bug-eyed ones called “the greys”) lean over them and carry out medical procedures.
- They may have an implant placed in part of their body – such as the head, nose, ear, arm.
- They may have eggs or semen taken.
- They may see other people while on the table.
- They are returned to their previous location, usually with time having elapsed inexplicably – they have “missing time.”
- They experience headaches, bad dreams and a loss of memory about the incident.
- They may have scars and/or scoop marks on parts of their body and they may not be aware of these until days later.
- They may experience ongoing symptoms of chronic fatigue, nausea and other related conditions.
- The whole experience may not be held in their conscious memory.

This chapter just focuses on a few cases with which I have some familiarity and I include some of my thoughts about them. As with other chapters in this book, whole sets of books have been written about the topic covered here. Well-known authors who have written about the alien abduction phenomenon include Dr David Jacobs, the late Budd Hopkins, the late Dr John Mack. Perhaps even more important to consider is the work of less well-known, [author the late Dr Karla Turner](#),²⁸⁹ so I direct interested readers to their works. [Some have argued that much of the abduction phenomenon appeared in parallel with the development of the CIA’s MKULTRA mind control](#)²⁹⁰/brain washing programme that was initiated following World War II.

Then, there are the extended experiences that Horror Novelist Whitley Strieber had with “The Greys”, written up in “[Communion](#)”²⁹¹ (1988) and “[Transformation](#)”²⁹² (1992) and several other books published since. [This seems an appropriate point to mention that Aleister Crowley’s drawing of the entity he said he communicated with \(or even “invoked”\) bears an obvious resemblance to the classic grey alien.](#)²⁹³ This, of course, leads some people to the quick step of saying “aliens and greys are all demons working with the devil to divert people away from the teachings of Jesus/God.” This is at best a simplistic view and at worst an indefensible closed-minded fundamentalist assumption.

As we shall see, the total range of experiences reported by abductees is very large – and mostly bizarre – stretching our credulity to the limits.

10. The Interrupted Journey



Betty and Barney Hill in the 1960s

The “Space Brothers” contactee era of the 1950s did not seem to last into the next decade. The Hills were two articulate and intelligent people, who held responsible jobs in their community. In 1961, they had a disturbing night-time experience while driving back from a vacation to the Niagara Falls area.

Their story got out by accident after a reporter published an article about their strange experience without their permission. They didn’t want any publicity

at the time, but they felt forced into publishing their account, because too many false rumours and misquotes began to circulate. If you want a detailed account of their experience, it is best to read [John G. Fuller’s 1966 book](#)²⁹⁴ - “[The Interrupted Journey](#).”²⁹⁵ I give a summary below, which is partly based on an [excellent article](#) by [Peter Crawford](#)²⁹⁶.

On 19 September 1961, Barney was driving the couple back along U.S. route 3 in their 1957 Chevrolet Bel Air, to their home in Portsmouth, New Hampshire, USA after a vacation in the Niagara Falls and Montreal area. The UFO sighting happened at around 10:30 p.m. when Betty Hill had been watching what she thought, initially was a star, but she noted it was moving as if it was being piloted. She told Barney to stop the car, so they could both walk their dog and get a better look at the object. They both observed the object through binoculars and it then came towards them. They got back in the car and drove slowly towards an isolated area called Franconia Notch and they continued to try and watch the object as they drove along.

They had driven about 1 mile to the south of a place called Indian Head when, the object, which they had continued to watch, rapidly descended toward their vehicle and Barney then stopped in the middle of the road! The Hills then became more agitated but continued to observe the craft at close range. On page 15 of the Fuller book, we read:

Barney later described it swung in a silent arc directly across the road, not more than a hundred feet from him. The double row of windows was now clear and obvious.

The huge, silent craft hovered approximately 80–100 feet above them and filled the entire field of view of the windshield. Barney had a pistol in the car and with this in his pocket, he moved closer to the object. He looked at the craft, again using the binoculars. He saw between 8 and 11 figures – humanoid - who were peering out of the craft’s windows, seeming to look at him. Then, all but one of the figures moved back to a panel on the rear wall of the front portion of the craft. The figures at the back appeared to be working some

controls, while the one remaining figure at the front looked at Barney and communicated a message telling him to “stay where you are and keep looking.” Red lights on what appeared to be bat-wing fins began to telescope out of the sides of the craft and some type of ramp or ladder came down from the bottom of the craft. Barney got a good view of the creature that was looking at him and found the eyes to be particularly frightening. He then got the impression that they were going to be captured and so, in great fear ran back to the car, threw the binoculars onto the back seat and then told Betty what he thought, and he drove off at high speed. It appeared that the object followed them and hovered above them. On pages 17-18 of Fuller’s book we read:

Then suddenly a strange electronic-sounding beeping was heard. The car seemed to vibrate with it. It was in irregular rhythm-beep, beep beep, beep, beep-seeming to come from behind the car, in the direction of the trunk. Barney said, “What’s that noise?” Betty said, “I don’t know.” They each began to feel an odd tingling drowsiness come over them. From that moment, a sort of haze came over them...

Sometime later, how long they were not sure, the beeping sound repeated itself. They were conscious only that there were two sets of these beeps, separated by a time span they had no idea about-as well, what had happened or how long it had taken. As the second set of beeps grew louder, the Hills’ awareness slowly returned. They were still in the car-and the car was moving, with Barney at the wheel. They were silent, numb, and somnambulist. At first, they rode silently, glancing out at the road to see just where they might be. A sign told them they were somewhere in the vicinity of Ashland, thirty-five miles south of Indian Head, where the inexplicable beeping had first sounded. In those first few moments of consciousness, Betty remembers faintly saying to her husband: “Now do you believe in flying saucers?” And he recalls answering: “Don’t be ridiculous. Of course not.”

Their memories of the latter half of the journey were hazy and when they got home at about 5am, they both noted their watches had stopped and it seemed to be a bit later than they expected. They knew something had happened, but they weren’t really sure what. Barney had an urge to go into the bathroom and examine the area around his groin, but he didn’t know why. They didn’t particularly want to remember the incident but thought that the sighting they had of the craft would be an interesting story to tell, at some point.

They awoke in the afternoon and still felt that something unusual had happened. Betty took the dress and shoes she wore and then put them in the back of a closet, for some reason – and never wore them again. She was later to have this dress examined, whence a residue was found on it.

Barney found that the tops of his shiny shoes were badly scuffed – which he could not easily explain, although he felt that he must have somehow scuffed them when he was walking away from the car to get a closer look at the craft.

Later on the same day, Betty called her sister Janet to tell her about the incident. Janet had had her own UFO experiences and suggested they might need to check if they (or their car) had been exposed to radiation. Janet said

that they could check for this by using a compass needle. After an argument with Barney, Betty found the compass and took it to the car. She noticed some strange spots on the trunk of the car and when she put the compass on them, it seemed to move differently. Barney was unhappy that Betty was talking about the incident and disagreed with her about the significance of the compass. Barney really wanted to forget about the incident – partly because it had been so frightening.

Janet had suggested Betty talk to Pease Airforce Base about their encounter and Betty called them up and Barney also gave the *basic* details of what they remembered. They deliberately omitted other details, however – fearing they would seem too fantastic for them to be taken seriously. The information was discussed with Major Paul W. Henderson, of the 100th Bomb Wing – and he made an official report to Project Blue Book – which was “in progress” at the time. (The report is reproduced in the Fuller book on pages 26-28).

On 26th September 1961, only a few days after their encounter, Betty Hill decided to write to Major Donald Keyhoe – author of the [1950 book “Flying Saucers Are Real.”](#)²⁹⁷ In this letter, she revealed more details of the encounter. On 21 October 1961, a NICAP member and Boston astronomer named Walter M Webb interviewed the Hills following their report being passed to him from Keyhoe.

That was not “the end of the story.” Ten days after the encounter, Betty had five nights where she experienced disturbing, vivid dreams and in November 1961, she started to write down what she could remember of them. In the dream, it was the night of the incident and they encountered a roadblock, then men came over and surrounded their car. Further, she described how they were both forced or goaded to walk into the forest and then up a ramp into the craft – a metallic disk. She noted how Barney seemed to be in a trance as he walked beside her. Betty identified a leader who she was scared of at first, but as communication took place between them, she became less fearful. Here is the summary of what Betty dreamed, according to Peter Crawford. (From reading Fuller’s book, this summary is accurate.)

Betty then dreamt that a new man, similar to the others, entered to conduct her exam with the leader. Betty called this new man “the examiner” and said he had a pleasant, calm manner. Though the leader and the examiner spoke to her in English, the examiner’s command of the language seemed imperfect and she had difficulty understanding him. The examiner told Betty that he would conduct a few tests to note the differences between humans and the craft’s occupants. He seated her on a chair, and a bright light was shone on her. The man cut off a lock of Betty’s hair. He examined her eyes, ears, mouth, teeth, throat and hands. He saved trimmings from her fingernails. After examining her legs and feet, the man then used a dull knife, similar to a letter opener to scrape some of her skin onto what resembled cellophane. He then tested her nervous system and he thrust the needle into her navel, which caused Betty agonizing pain. But the leader waved his hand in front of her eyes and the pain vanished. The examiner left the room and Betty engaged in conversation with the “leader”. She picked up a book with rows of strange symbols that the “leader” said she could take home with

her. She also asked where he was from, and he pulled down an instructional map dotted with stars. In Betty's dream account, the men began escorting the Hills from the ship when a disagreement broke out. The leader then informed Betty that she couldn't keep the book, stating that they had decided that the other men did not want her to even remember the encounter. Betty insisted that no matter what they did to her memory, she would one day recall the events. She and Barney were taken to their car, where the leader suggested that they wait to watch the craft's departure. They did so, then resumed their drive.

Following another interview with NICAP members C.D. Jackson and Robert E. Hohman, it was realised that the Hills had about 2 hours of “missing time.”

Between 1961 and 1963, the Hills were troubled by memories of the incident and made several return visits to where they tried to identify the exact site where the events took place. There were the physical effects and symptoms which they couldn't fully explain. They had discussed the event with a few people and eventually talked about it at their local Unitarian Church group.

They went to see a Psychiatrist who referred them to M.D. Benjamin Simon, who was a Hypnotherapist. Dr Simon conducted sessions of hypnotic regression with the Hills between late 1964 and mid-1965. (Dr Simon also wrote an excellent introduction to John Fuller's “Interrupted Journey” book.) What follows is what was revealed in several sessions of hypnosis. Benjamin Simon regressed the Hills separately and then compared their stories. [The sessions were recorded and some of these recordings can be found on YouTube](#)²⁹⁸. (As you can read in “Interrupted Journey,” it was actually Barney Hill who suggested the tapes be stored securely, so that someone, in 20 or 30 years' time may be able to make sense of their experience in a wider context. He had great foresight!)

In the sessions, Betty described many similar details to what she had dreamed (but there were important differences). Barney also gave many details (which he had not reported dreaming about). Under hypnosis, he reported that while he was onboard the craft, he was also examined, but his examination was different. For example, a type of cup was placed over his genitals. In the regression session, you can hear how agitated Barney becomes – he was absolutely terrified. It is no wonder that he blocked out these memories!

One interesting and well-known aspect of Betty Hill's regression was that it seemed to reveal that she was shown a Star Map – as a kind of 3D projection or Hologram. The dialogue he had relating to this seems realistic – in that the alien showed her the map and said, “Do you know where you are on this map?” Betty did not know and so the alien said, “So is there any point in me showing you where I am from?”

This map (see below) was then analysed and commented on by various professional and amateur astronomers. [In 1968, Marjorie Fish, a School Teacher and amateur astronomer from Oak Harbour, Ohio, read the Fuller Book](#)²⁹⁹. From Peter Crawford's summary:

Assuming that one of the fifteen stars on the map must represent the Earth's Sun, Fish constructed a three-dimensional model of nearby Sun-like stars

using thread and beads, basing stellar distances on those published in the 1969 'Gliese Star Catalogue'.

Studying thousands of vantage points over several years, the only one that seemed to match the Hill map was from the viewpoint of the double star system of Zeta Reticuli.

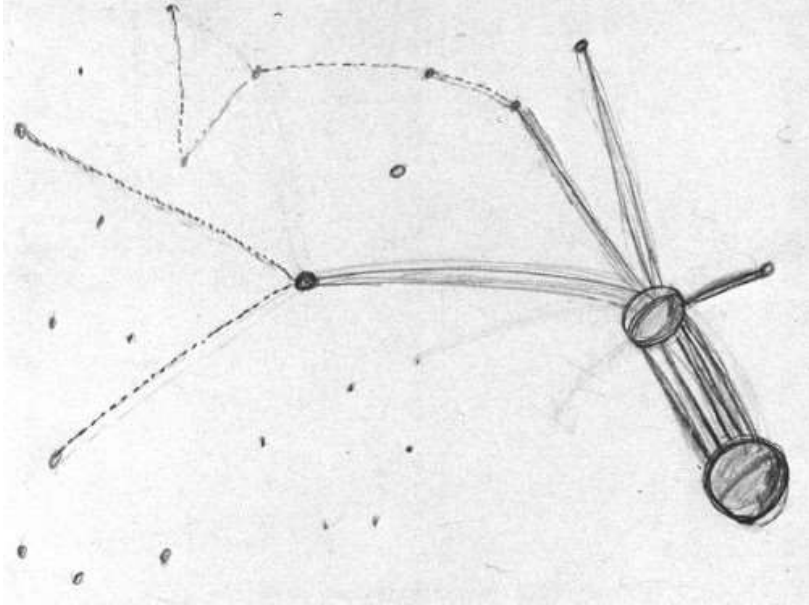

Betty Hill's Star Map

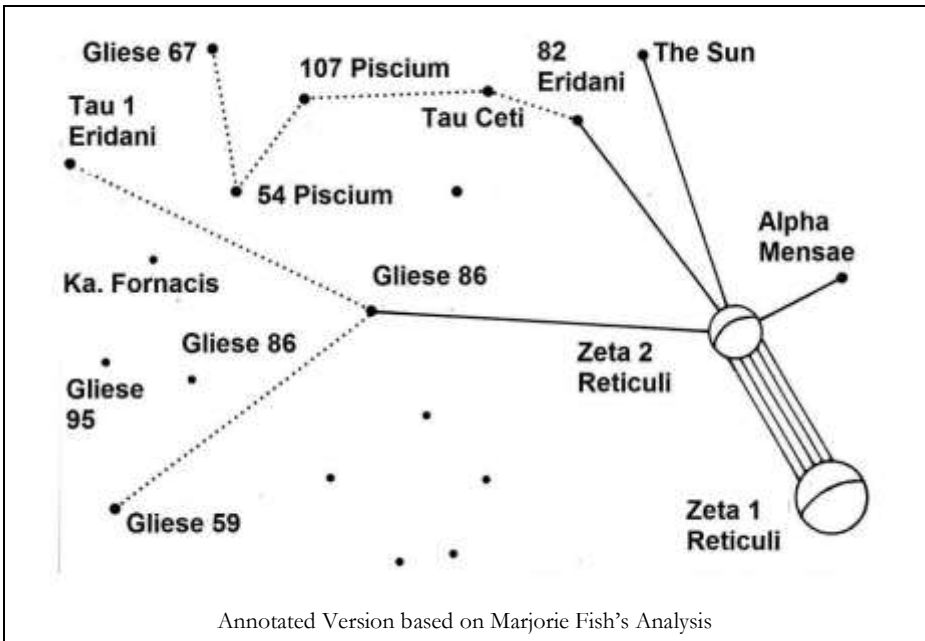

Annotated Version based on Marjorie Fish's Analysis

Some of the distances between these stars had not been determined in 1961. Debate has continued about what, if anything, the map shows. However, it seems quite likely that this was the main origin of the story, promoted by people like [Nancy Leider](#)³⁰⁰, that some aliens come from Zeta Reticuli. (Nancy Leider is certainly not a reliable source of information, as I discussed in “[Secrets in the Solar System: Gatekeepers on Earth](#)¹²⁴”.) But this is not to say that Marjorie Fish’s conclusions are wrong, [although more recent and more accurate astrometric data from the Hipparcos Satellite means that some of the distances Fish used were not accurate](#)³⁰¹. It would be tough to get verification that aliens have come to earth from Zeta Reticulum!)

I think that Dr Benjamin Simon, during the regression sessions, did an excellent job of eliciting details about what the Hills seemed to have experienced. Laudably, Dr Simon’s goal was simply to reduce or remove the anxiety and stress that both the Hills (and particularly Barney) had experienced since the event. He had trouble accepting that the Hills were abducted – believing that Barney had “absorbed” the details of Betty’s dreams. (This seems unlikely when you listen to the degree of Barney’s reaction.) After the regression sessions, the Hills were able to “handle” their experience more calmly, so Dr Simon’s efforts were successful.

I encourage readers to further study the story. In 1975, a [95-minute TV movie called simply “The UFO incident” was released](#)³⁰² where James Earl Jones (voice of Darth Vader) accurately portrays elements of what Barney Hill experienced in the hypnotic regression sessions. The film portrays the Hills as a loving couple who are simply trying to come to terms with what has happened to them. It draws heavily on what they reported about their experiences – from their conscious recall, and those experiences recalled under hypnosis.

Sadly, Barney died of a stroke in 1969 at the young age of 46. [Betty Hill told the same story about their experiences, until her death, at the age of 85, in 2004.](#)³⁰³

My own conclusion is that the Hill’s story involved a physical abduction by non-human beings – aliens, from another world (and which world that was is still unknown!) Based on the evidence the Hills provided, this same conclusion should have been openly stated and accepted by more people than it has, in the years since the events transpired.

11. Taken Up?

Travis Walton

One of the most well-known abduction cases, which does *not* fit into the description given in the introduction to this chapter, is that of Travis Walton. You can read a fairly detailed account of his experience [on his website](#)³⁰⁴, or even better, [buy his book](#) – “Fire in the Sky.”¹¹³ Similarly, you will find he has given many interviews – [the earliest recorded one of which I am aware of is from 1978](#).³⁰⁵ (You may be able to find earlier recordings though!).



Andrew Johnson, Travis Walton and Menna Trinder Widdess at Holmfirth UFO Truth Conference, 11 Sep 2016

A Flying Saucer

On 5th November 1975, Travis Walton, a resident of Snowflake, Arizona - was working on the Turkey Springs tree-thinning contract in Apache-Sitgreaves National Forest – about, 45 miles from his home. He was working with six other men – Mike Rogers (the “boss”), Allen Dalis and John Goulette. Dwayne Smith, Kenneth Peterson, and Steve Pierce. The men worked until dusk, which was sometime before 6pm. They then gathered their tools and equipment and travelled back home in Mike’s old pickup truck, with non-smokers in the front (three of them) and smokers in the back (four of them). While driving along the bumpy forest track, sometime after 6pm, at one point, Travis reported they initially saw a “yellowish brilliance” washing across their path about forty yards ahead of them. They couldn’t see the source of the light initially and wondered if it was hunters’ lights, the light from the setting sun or perhaps an aircraft coming down. A few moments later, Rogers, had to stop the truck to get a better look. At that point, Allen Dalis shouted “It’s a flying saucer!”

In his account, Walton writes:

There, a mere twenty feet above the ground, a strange, golden disc hovered silently... Less than thirty yards away, the metallic craft hung motionless,

fifteen feet above a tangled pile of logging slash. The craft was stationary, hovering well below the treetops near the crest of the ridge. The hard, mechanical precision of the luminous vehicle was in sharp contrast to the primitive ruggedness of the dark surroundings. Its edges were clearly defined. The golden machine was starkly outlined against the deepening blue of the clear evening sky...

I estimated the object to have an overall diameter of fifteen or twenty feet; it was eight or ten feet thick. The flattened disc had a shape like that of two gigantic pie-pans placed lip to lip, with a small round bowl turned upside down on the top. Barely visible at our angle of sight, the white dome peaked over the upper outline of the ship. We could see darker stripes of a dull silver sheen that divided the glowing areas into panel-like sections. The dim yellowish light given off by the surface had the luster of hot metal, fresh from a blast furnace. There were no visible antennae or protrusions of any kind. Nothing that resembled a hatch, ports, or window-like structures could be seen. There was no motion and no sound from the craft. It almost appeared to be dead in the air.

At this point, Walton jumped out of the truck and ran towards the saucer, then began to crouch down a little, as he got closer. He stood more or less beneath it, gazing up at it, awestruck. Momentarily, he looked back to the truck, where everyone else was panicking and shouting, wondering why on earth he would approach the craft, when they were all so terrified of what they could see. Walton recounts:

I had become aware of a barely audible sound coming from the ship. I could detect a strange blend of low and high-pitched mechanical sounds. There were intermittent high, piercing, beeping points overlaid on the distant, low rumbling sound of heavy machinery. The strange tones were so mixed that it was impossible to compare them to any sound I could remember ever hearing.

Hit by a Beam?

Moments later, he heard a “thunderous swell” in the volume of the vibrations from the craft and he observed the craft beginning to wobble on its axis, like an unstable spinning top. Then, a blue-green ray shot from the bottom of the craft and hit him full-on, throwing him backward about 10 feet, and he hit the ground with his right shoulder. He was knocked unconscious and his work colleagues/friends saw him motionless on the ground. Of course, they were extremely frightened and drove off, almost in a blind panic.

They drove down the hillside for a few minutes, still terrified of what they had just witnessed. The bumpy road, however, was taking its toll on the truck, so Mike Rogers had to slow down. They approached the Rim Road and, by then, had regained enough composure to realise that they should not leave Travis, who was potentially dead, back in the forest. At about the same time, Mike Rogers said that he actually saw the golden disk leave the area, at an incredible speed, to the North East.

Where's Travis?

The 6 men returned to the area where Travis had been thrown to the ground. They were alarmed to discover he was no longer there. They used the truck's headlights to illuminate the area and, with fear and caution, searched a little further away from the site, using a torch. In his abridged account, Walton writes:

They searched beyond the crest of the ridge and farther south. They found no sign anywhere — no foreign objects or unusual markings. No burns, pad impressions, or disturbed ground. Not a trace of tracks and no evidence of a struggle.

After more searching, the men had to return home – without Travis. They decided to call the police for help and a Deputy named Ellison and later Sheriff Marlin Gillespie got involved. Gillespie said later that the crewmen were “sincerely distressed.” The officers and group of loggers went back up the hill again and searched more with flashlights but found nothing and decided to resume the search, early the next morning.

More extensive searches for Walton were conducted over the next few days, but he was not found. The logging crew fell under suspicion that they had murdered Walton, and so agreed to take a Polygraph Test – which was conducted by Cy Gilson, who worked for the State Police. Though you can read further details about these tests (and re-tests), they essentially indicated that all the men were telling the truth – that Travis had disappeared after they'd seen him approach a flying saucer.

Travis is “Elsewhere”

Even more intriguing was Walton's description of what he experienced when he regained consciousness.

He was lying on a raised table of some kind, looking up at a suspended, diffused light source – about three by one and a half feet. He was in considerable pain, very weak and his vision was initially blurred. He felt that the air was hot and humid – stifling, in fact. He thought he must be in the hospital. His jacket was still on, bunched up under his arms. Walton's account reads thus:

Then I felt something pressing down lightly on my chest. It felt cool and smooth. I looked down and managed to hold my eyes open long enough to see that my shirt and jacket were pushed up around my shoulders, exposing my chest and abdomen. A strange device curved across my body. It was about four or five inches thick and I could feel that it extended from my armpits to a few inches above my belt. It curved down to the middle of each side of my rib cage. It appeared to be made of shiny, dark gray metal or plastic.

I looked past the upper edge of the device. I could see the blurry figures of the doctors, leaning over me with their white masks and caps. They were wearing unusual, orange-colored surgical gowns. I could not make out their faces clearly.

Walton then describes how terrified he was, when he realised he was in a room with three alien-looking beings of a rather puny build and appearance, with very large eyes and bald heads. He seemed to recover enough to lunge at them, and they left the room. He then also left the room, in the opposite direction. He found himself in a corridor and, running along this a short distance, he entered another circular, domed room, which seemed to be empty, apart from a single chair in the middle, which he could only see the back of. He approached the chair cautiously, thinking there might be someone sitting in it. On the arms of the chair, there were some unlabelled controls – some buttons, a lever and a small screen. As he approached the chair, the walls of the room seemed to “fade out” and he could see stars in the blackness of space. He sat in the chair and found that both the chair itself and the controls seemed to be suited to someone of smaller build than himself. He fiddled with the controls and noticed that the stars seemed to move. He then stopped and realised that he might be actually flying the ship and he did not want to cause it to crash! He was still feeling weak and he was trembling. After looking for other exits from the room, he heard a noise and looked back to the original door. A human-looking figure was standing there. The figure was about six foot two, male and wore a clear helmet and a bright blue suit made of velour-like material. Walton felt a sense of relief, thinking the man might help him. He ran up to the man, and repeatedly asked him questions, still in a distressed state, but the man remained silent, took him gently by the arm and led Walton out of the room. He hurried him down the narrow corridor/hallway with Walton behind the man, as the hallway/corridor was quite narrow.

After a few minutes, they entered a small cubicle, not much bigger than the space they occupied while standing in it. They waited in there for a couple of minutes before emerging into a much larger room, when Walton was led down a ramp. The larger room was much lighter inside and the air cooler and refreshing. Walton inhaled deeply, and he began to feel a bit better. The ceiling of the large room had dark rectangles and ones emitting light and it curved downwards to form one of the walls – like being inside a quarter of a cylinder, he thought. The craft he had emerged from was larger than the one he had seen in the forest. He was led across the room by the silent man and noticed other shiny rounded craft. He was led into another hallway and through some double doors (which opened automatically) and then into a white room which was about 15 feet square and a ceiling about 8 feet high. In this room there were two similarly perfect-looking men and a woman, but they did not have helmets on. Walton thought they looked as if they were all part of the same family. He asked more questions, but everyone still remained silent, though he did not feel they were being hostile to him. He was lifted onto the table, at which point he began to protest, but all three of them gently pushed him back down onto the table. Following this, the woman placed a clear mask (which had a black golf-ball sized sphere in the centre - no tubes were connected) over his nose and mouth.

“We’ll Drop You Back Home Now...”

The next thing he remembers was regaining consciousness, while lying on the road, which he soon recognised was the road west of Heber, about 35 miles from his home. Looking up, he saw a small light, which was quickly extinguished, and he wondered if this was a hatch or door closing – because he could see a disc with a mirror surface hovering about four feet above the surface of the road. He realised this was, most likely, the craft that had returned him. He watched it shoot vertically into the sky, at very high speed. The only sound he heard was the rustling of dry oak leaves that were in the grass at the side of the road.

Still very shaken, he picked himself up and ran a distance down the road and over a bridge, finding some telephone booths at the Exxon Gas/Petrol station. He phoned his sister - it was just after midnight on the night of November 10th. Initially, his brother in law, Grant, answered and didn’t believe it was Travis. After some discussion, Grant drove over to Travis’ brother’s house and then Duane (Travis’ brother) and Grant drove out to get Travis.

Collecting him from the phone booth, Travis was still in shock. It quickly emerged in conversation that Travis did not realise that he had been “away” for five days. (Travis thought it was only a few hours, until he realised his facial hair had grown considerably.)

Consistent Facts

These facts, were compiled into a book (“The Walton Experience”) published by Walton in 1978. Walton has been giving the same account, since the first day he was able to do so – a period of almost 43 years, as I write this text.

He underwent hypnotic regression, which helped him to recall some more detail and deal with some of the anxiety he had been living with. However, the main features of his story were always part of his conscious memory.

In his book, he gives considerable detail about what happened after his return – for example, his clothes were bagged and tested, and a urine sample was taken. He initially got involved with a group called Ground Saucer Watch, but the role of this group was later called into question, when Walton found out that the doctor recommended by the group had questionable credentials.

For a number of years, Walton felt that he had been taken into the craft maliciously, but having had time to reflect on what happened, he thought it was perhaps more likely that his initial, rather reckless, actions meant he had put himself in danger, such that when the craft powered up to leave the area, he was accidentally caught in the process of the craft “powering up” and the occupants decided to “scoop him up” and “fix him” before he returned. He has remained in good health ever since. However, Walton has stated, on more than one occasion:

“If I had to do it over again, I wouldn’t get out of the truck.”

NATL. ENQUIRER Dec. 16 '75
5 Witnesses Pass Lie Test While Claiming . . .
Arizona Man Captured by UFO

In one of the most baffling cases ever recorded, a young laborer was taken aboard a UFO — in full view of six terrified co-workers — and held for five days.

The stunned witnesses readily agreed to take lie-detector tests. Five passed proving they were telling the truth. The sixth was so nervous that the results of his test were inconclusive.

The abducted man, 22-year-old Travis Walton of Stanflake, Ariz., mysteriously disappeared when struck by a dazzling ray from the strange hovering, saucer-shaped object, his fellow workers told police and The ENQUIRER.

In gripping detail, the witnesses described the startling incident.

Dwayer Smith, 21: "It was a squawky, there's no doubt of that — and Travis went on it. He got out of our truck, walked toward it — and just vanished!"

Russell Peterson, 21: "I saw a bright light come from the machine and Travis went flying — like he'd landed a hot wire."

Alan Dale, 21: "It just ran a blue ray, and the last we saw of Travis was his silhouette without a head — and he vanished. We couldn't believe what was happening — the horror was unreal!"

Mike Rogers, 21: "We were all scared! We couldn't think of any other explanation except that Travis had been taken off by the saucer."

John Gaudin, 21: "I know

By TONY BRENNHA, JOHN W. CATHCART, CHRIS FULLER, PAUL JENNINGS, RICH LONGHURST, ROBERT G. SMITH and JEFF WELLS



SKETCH of hovering UFO shown by Mike Rogers and Dwayer Smith.

five witnesses were heading home at dusk along an isolated mountain road. One witness, Dwayer Smith, said they were about 12 miles from Heber when they suddenly spotted the saucer hovering in a clearing beside the road.

"I was much with disturbed — and terrified," said Smith. "The UFO was saucer- and was giving off a brilliant orange light."

"We watched it in shock a few seconds, then authority

just vanished! Mike Rogers, who was driving the truck, screamed 'that the door' and jumped out the saucer."

"When we could see the saucer wasn't following us, Mike chopped the truck and we all got out, shouting and screaming at each other with fear in our faces and terror in our hearts. Then we saw a flash in the trees, and figured the saucer was leaving."

"We went back to the spot where the saucer had been . . . but Travis was gone. He went on the morning, there's no doubt of that."

"We went and reported what had happened. We didn't expect anyone to believe us, and schools did — until we took lie-detector tests."

Because Walton wasn't able to recall all the details of his amazing experience, The ENQUIRER arranged for him to be interviewed under hypnosis by Dr. Harold A. Wheeler, a member of The ENQUIRER's production



EXPERTS QUIZ abducted man, Travis Walton (center). At left is Dr. Alan Rosenbaum, at right Dr. James Barker.

Dr. Barker that as he approached the craft for a closer look, he was hit by something and instantly everything went black.

"When I woke up, there was a strong light in my eyes and I had painless itching. I was panicked because there was a terrible pain in my head and chest," he told Dr. Barker.

"My mind cleared a little and I thought I was in a hospital. I was lying on a table on my back, and these figures were standing over me."

"It was weird. They weren't human — they were creatures. They looked like well-developed insects to me — they were about 5 feet tall and wore light-fitting, tan-brown robes. Their skin was white like a mushroom and they had no clear features. They made no sounds."

"Their faces had no features or color, and there was no hair. Their limbs were chiseled and their eyes were very large. They had long fingers — like an Hesperid."

"I jolted and jangled up, knowing a clear plastic tray



SHERIFF Austin Galloway: "I'm sure they are UFO."

ing stored the craft — and the description of the creatures he saw fitted the description given by Walton.

"There's been no publicity about this case because the town fears it would jeopardize its job in tourism."

Fire in the Sky – The Movie and Book

In 2010, Travis Walton re-published an updated and expanded version of his book and this, at the time of writing, is still available from his website. In the new book, Walton includes further evidence that the event happened just as they had all said. For example, trees near the site where they witnessed the saucer have shown anomalous growth after 1975.

In 1993, a film/movie starring Robert Patrick (of Terminator 2 fame) and D.B. Sweeney (who played Travis) was released.³⁰⁶

In his 2010 book, Walton describes being involved with the making of the movie and how his story was changed, to some degree, from what he wrote in his original "Walton Experience" book. Most of the changes he was quite comfortable with, as they were made to streamline the true story a little, so that it could be presented succinctly and in a more engaging manner within the two-hour running time of the film.

However, one thing he was not happy with was the "abduction sequence." It was changed completely, with the result that it portrayed events where Travis' clothes were removed and he was physically abused, terrorised and violated by the ET's. This is the opposite of what actually happened! The movie scenes are extremely harrowing, if you ask me.

Possible reasons given are that Movie Executives overrode the wishes of Walton and Tracey Tourme (who wrote the screenplay) in a bid to perhaps make the movie into a horror film or to appeal to a certain audience. Whoever made the decision to spend millions of dollars on the complex effects and animatronics sequences, using aliens which looked nothing like the ones

Walton described, was not interested in giving an accurate account of the actual events as Walton had reported.



A still from the Hollywood version of Travis' abduction

Was this done to just “fit in” with the stories of the negative/abusive abduction accounts, which had been emerging over the previous 30 years? Was it just that movie executives had read [Whitley Streiber's “Communion,”](#) (first published in 1988) and wanted to make the Walton abduction experience like that of Streiber's?³⁰⁷

Personally, I would have much preferred to see an embellished or “enhanced” version of the experience Walton *actually* described – i.e. actually meeting *two different types of aliens*, apparently *piloting one of their craft* for a period of time and also seeing *several different types of craft*, before being returned *with his clothes on* (not *injured* and not *naked*, as portrayed in the “return” sequence of the 1993 film).

Fire in the Sky – The Book, and Steve Pierce

Just over 80 pages of the 396 pages in the new 2010 book are about the encounter and experience itself. Over 90 pages are devoted to addressing Philip Klass' ongoing debunking attempts and attacks on Walton and the group of men who shared the experience.

After the book was published, new information about the activities of Klass came to light. In 2012, the youngest member of the group of men, Steve Pierce, re-emerged into the limelight, having kept a very low profile for many years. [In interviews he gave at that time](#)³⁰⁸, Pierce related how he suffered greatly after the incident, to the point where he did not want to be associated with the case at all. He struggled emotionally in a number of ways – he said that what hurt him the most was that his family would not believe him. He also said that even his wife was embarrassed when Pierce told the story in company. He felt that even his wife didn't believe him. Pierce moved away to Texas, as he was being continually harassed. He started to be known by his first name, “Geoff” – Steve was his middle name. He began working as a truck driver.

In the 2012 interviews, Steve explained that he came forward because of his daughter. They ended up watching the 1993 “Fire in the Sky” film, together and he told her “That’s me – but they changed my name.” His daughter said, “prove it,” and this then prompted him to re-establish contact with Travis Walton in the Summer of 2011.

In the interviews, Pierce explained that, in 1978, Philip J Klass had offered \$10,000 to Pierce to declare the story a hoax. At the time, Pierce needed the money, but he did not accept the bribe. How is it that Klass could offer this amount of money? Even if it was from his own personal funds or fortune, why would he make such an offer? Klass harassed Pierce for years and, on one occasion, even drove out to Texas to find him! Pierce also stated that even quite recently, he had been offered money to denounce the case as a hoax.

[Knowing this, how distasteful is it to see Klass being referenced on web pages defending officially sanctioned hoaxes, such as Apollo?](#)³⁰⁹

Travis Walton - Conclusion

The case of Travis Walton is, as far as I am concerned, important because it shows us:

- Mechanical craft with advanced propulsion systems have visited the earth.
- Different alien races are working together in some way (unless, of course, we are dealing with some type of robot in some of these cases).
- They are able to take us into their craft and they seem to understand our physiology.
- At least some of these beings have a benign nature.

Even Travis Walton himself would not be “so bold” as to state this! (I can understand why he is more reserved about these sorts of statements.) In his book, Walton explores the meaning of his experience, in sensible ways.

One note that struck me was that Walton did not receive any telepathic communication with the ET’s and no attempt seems to have been made by the ET’s to affect or change Walton’s memory of the incident.

Robert Taylor, Attempted Abduction – 1979

Four years after the Walton case, on 9 November 1979, another abduction attempt took place, also in a forested area. This case is unlike any other I have heard of – seemingly involving mechanical spheres, but no beings were observed or encountered. The event was covered very well in [Episode 3 of Series 1](#)³¹⁰ of a UK TV documentary programme “Strange But True,” broadcast on 4 November 1994. It also featured an interview with SPI researcher and investigator Malcolm Robinson, who undertook an ongoing and detailed investigation into the case, having met Robert Taylor the day

after the event. Robinson [spoke in detail about the case at the IUFO conference in 2009](#).³¹¹

The case is [concisely described in an excellent article](#)³¹² by [Patrick Gross](#)³¹³.



Robert Taylor at the Site

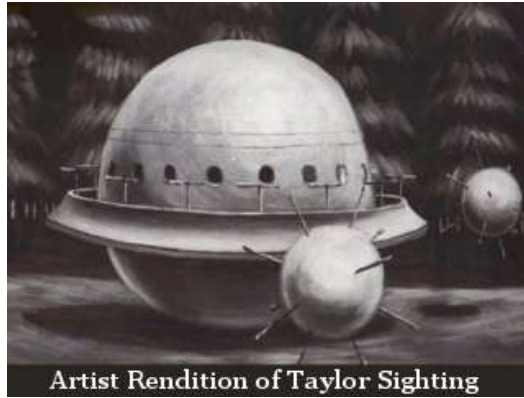

For Robert Taylor, it was an ordinary day in the forest, where he had to make sure things were “in order” and that there weren’t any livestock that had got into areas of the forest where they weren’t supposed to be.

He worked in Dechmont Woods and had driven down a forest track to check a clearing, which was quite close to the M8 motorway. He then walked into the clearing with his Red Setter dog, Lara.

Taylor was stunned and bewildered to see a metallic looking sphere (as shown above). The sphere became partly translucent and he was, momentarily, able to see the trees behind it!

From the larger sphere emerged two smaller ones, which rolled rapidly towards him on spikes, making a squelching or sucking sound. He was transfixed. The small spheres were about 2-3 feet in diameter and looked reminiscent of sea mines, but the spikes were longer. The spheres came right up to him and the spikes tore into his trousers and also scraped the skin beneath. His dog was barking and Taylor fell to the ground, unconscious.

He regained consciousness about 15 minutes later and the object had disappeared. He was barely able to move and had a severe headache. He crawled to the truck and managed to climb in, but only drove a short way before ending up in a ditch. He got out again and staggered a distance of about one mile to his home, where he found his wife.

He told her he’d seen a “spaceship” but she didn’t believe him, although she could see he had been physically affected. He had a raging thirst and a metallic taste in his mouth.

His boss, Malcolm Drummond, was called and he went back to the site and found the abandoned truck.

Taylor stated he had been “gassed.” The police were called, as was a doctor – who sent Taylor to hospital. Taylor, however, discharged himself and was not

examined. The raging thirst and headache subsided after a couple of days and he had no further obvious symptoms.

The police, under the supervision of Detective Sergeant Tan Wark, did an investigation, which involved cordoning off the site of the incident. They photographed the tracks and forty holes in the ground – which matched with what Taylor had described. Various forestry equipment was examined but it was concluded that none of this equipment could have made the tracks.

A police forensic specialist named Leicester Knibb analysed the trousers and found damage which was consistent with Taylor's account of what happened.

The case is still regarded by the police as one of assault – by person or persons unknown.

Explanations

There is no sensible/coherent explanation for this case other than it happened exactly as Taylor described. This has, of course, not stopped sceptics from coming up with something quite ridiculous. For example, Science writer Steuart Campbell said in the “Strange But True” episode:

He thought he saw spacecraft – because that was the only logical explanation to him... sitting in a clearing... but it was a magnified image – in my opinion – of a planet millions of miles away... It caused him to be paralysed, he couldn't speak, he was unable to walk...

Campbell suggested these were symptoms of epilepsy! Yes, really! So as well as disregarding the evidence documented in the police investigation and by witnesses, he also disregarded the fact that Bob Taylor had no history of epilepsy. Patrick Gross noted in his article, that Campbell was an investigation coordinator at BUFORA and had actually investigated the case himself, some years before the 1994 ITV programme and had apparently stated:

After our investigations we have no reason to disbelieve Mr. Taylor's story. In fact, he is the most reliable witness of a close encounter BUFORA has ever had.

It is therefore a mystery as to why Campbell would make such ridiculous statements on camera for the TV documentary...

Alan Godfrey and Zigmund Adamski Case



PC Alan Godfrey in the 1990s

Alan Godfrey's case has been extensively written about and at least three [dramatic reconstructions](#)³¹⁴ of his case have been made since it happened. (Hence, further details can be obtained by studying those.) In 2018, [Alan Godfrey released a book about his experiences called “Who or What](#)

are They?"³¹⁵

In 1980, UK Police Officer Alan Godfrey³¹⁶ was involved in [two incidents which have some kind of UFO/alien connection](#)⁶.

Zigmund Adamski Disappears and Reappears

On 6th June 1980, in the small UK town of Tingley, West Yorks, a polish immigrant named Zigmund Adamski left home to buy groceries. Five days later – on 11th June 1980 - his dead body was discovered on top of a coal tip in Todmorden, 20 miles away. The body was found with a jacket on, but without a shirt and Adamski's wallet and watch were reported to be missing. The death was unexplained and the Coroner, James Turnbull, who was called in to handle the [case stated in a 1993 interview](#)³¹⁷ that it was one of the most puzzling cases he had come across in 25 years. He said:

If someone proved to me that UFOs exist and that there was one around there at that time and that, in some way, we could associate it with this case, then perhaps I might say I'd only raise half an eyebrow...

He had said this because, for example, a jelly was found on the back of Adamski's neck, near where his head had been partly shaved and this jelly could not be identified.

Only five months after he found Adamski's body Godfrey himself, in November of 1980, had an apparent abduction case.

Alan Godfrey, a Herd of Cows and a Hovering Craft

On the night of 28th November, Godfrey was called to investigate an incident involving cattle being released on a council estate, in Todmorden. In a [2018 YouTube Interview](#)³¹⁸, Godfrey described the event:

I was on nights - night patrol which starts at 10:00 p.m. till 6:00 a.m. A call came in to the local Nick (police station), where we were stationed, regarding some cows that were wandering around a local council housing estate... which is on the right-hand side of the valley ... Burnley Valley... Me and one of my colleagues went up in the police car and went round the estate ... couldn't see anything. No trace of these cows. We put it down to a prank call ... and then ... several calls came in and we just thought it was pranksters. Then one came in apparently from ... an old lady that lived in one of the bungalows, so I went to see her. She said she heard this noise outside the building and she looked out of a bedroom window, she saw these cows. As she went to report the matter ... she says there was like a flash of light and when she next walked - out they've gone! We searched the area up and down each Avenue - no trace at all!

About 5:00 a.m. - an hour before my shift was due to end - one of my colleagues (Paul Richardson) who was doing the switchboard - was (then) going off duty. So I left the police station with him. He lived in the... flats across from the police station [which were police accommodation] and said "see you later - see you tomorrow..." I jumped in the patrol car and I went down into Todmorden town centre, which is ... less than half a mile away from the police station. When I got down there and I saw the staff bus was going up Burnley Road [Bobby Coats was driving].

Returning to the town, Godfrey stopped for about 5 or 10 minutes to speak to a colleague who was on foot patrol, asking him if he wanted to go and check for the cows. The colleague declined so Godfrey turned the car around and went back past the police station. Then, while on Burnley Road, he was about to turn into Ferney Lee Road which led up to the housing estate. But in the centre of the road about 250 yards in front of him, he saw a strange sight:

At first I thought it was a bus gone sideways... so I drove slowly towards it... I got within 20 yards of it. I stopped the police car and right there - just hanging above the road - was this object. It wasn't touching the road - it was about five feet off. I could see under and it was about twenty feet wide and about fourteen feet high. It was shaped like a diamond. I mean, "hot-air balloon" came to mind. You know, these things go through your head... Your brain's trying to work out what you're actually looking at. I put all my blue flashing lights on and, you know, and they were reflecting back off it.

Godfrey noticed that the autumn leaves were swirling around underneath the object. He then tried to use his personal radio and car radio to report the incident, but both were inoperative/dead and therefore he could not make a report.

As I looked at this object... as I say it was diamond-shaped... there looked to be black panelling across the top of it - or it could have been glass, I don't know - but it was black and there's like... a light on top of that - like a fluorescent type thing... It was just spinning and at first, I thought it was spinning anti-clockwise - it was like an optical illusion. You know, when you see wheels on a car on a film, they look to be going backwards. It made that impression in my brain, as I'm looking at it, but the leaves were going the opposite way - very weird.... We had no cameras with us or anything so the best I could do to keep a record of it... So, I picked my clipboard up...and I just started to draw it. And then... "Whoosh"

Godfrey described being temporarily blinded by a white light like a thousand camera flashes going off at once. After this, Godfrey describes:

It had gone... and I, for some strange reason, was another twenty yards further up the road, driving the bloody police car... I shook my head... I turned the car around, came back to the scene and I got out of the police car. I could see on the road - it had been raining as I said - there was this "dry whirlpool" on the tarmac... All these leaves as well... very strange.

Godfrey went back to the town centre and found his fellow officer and brought him back to the scene. He saw that it (the strange dry patch) was still there. Godfrey reported that they then found the cows on the Rugby pitch, in Centre Vale park, right next to where the incident happened. From where they were, they had to go through locked gates to get to where the cattle were located, about 20 meters away from where this UFO had been. Godfrey could not explain how the (unharmd) cows could have got into the park - as the only other route, apart from going through the locked gates, was perhaps by walking about a mile and perhaps through another entrance. The cattle belonged to Royd Farm, quite some distance away, above the park, on the side of the valley.

Abduction or Imagination?

Godfrey reported that when he returned home, he found a split on the left sole of his (fairly new) “Doc Martin” Boots. He also noticed an itchy red patch on the instep of his left foot. He put on some ointment and went to bed. Godfrey later was told, when others were investigating his case, that he had lost about 15 or 30 minutes of time. Godfrey’s experience was, without his knowledge, reported in the local press about a week after the events.

Years after the event, Godfrey learned of other reports and sightings of objects, near Todmorden, on dates before and after his own encounter. One such sighting was made by another police officer called John Porter, who was out at a local quarry searching for stolen motorbikes.

Godfrey later underwent sessions of hypnotic regression, which involved UFO investigator Harry Harris. However, a Police superintendent contacted Godfrey and told him he could not partake in any more sessions.

Some of the sessions with Harris had been recorded on video and Godfrey, at later meetings with Harris, was shown the tapes. Godfrey couldn’t believe what he had said while under hypnosis and he reported that when going home after the sessions, he had been sick and then he had bad dreams or nightmares. While in a trance, Godfrey gave an account of what happened in the “missing time” period. [An account by Harry Harris](#)³¹⁹ said

Alan describes getting out of his car, looking at the object then he sees a light emanating from underneath it so he gets back into his car, finds his car won't go and then he's engulfed in a bright white light. He appears to lose consciousness. He says everything is black. He then wakes up in a room where he sees a tall man (who was wearing a skull cap, Godfrey described). He's also surrounded by six small "horrible" robots. He's made the subject of some sort of pseudo-medical examination. In due course, he's put back in his car.

Godfrey himself does not know whether “what came out” under hypnosis was true, or whether it was the result of stories and accounts he had read in the time between his encounter and when the hypnosis sessions took place. Godfrey points out that he was replying to questions, rather than openly giving an account. He mentioned he saw a dog during his experience. He also notes how difficult it is to recall all the details of the possible abduction, as they were not part of his conscious memory. Godfrey is often misquoted as claiming he had an abduction experience – when he has never claimed such a thing. He has merely reported that this was what he recounted when under hypnosis, but this is not part of his conscious memory.

However, what he has confirmed is that before this encounter, he was infertile, due to him being assaulted while on duty. After the incident, a hospital check-up revealed that he had become fertile again and subsequently, he had another child.

Godfrey’s case became international news and this apparently created problems for him at work and a number of wrongful accusations were made against him. Like Travis Walton, Godfrey has told the same story since the

event itself happened in 1980, only a few weeks before the Rendlesham Forest landings.

Alan Godfrey - Conclusion

If it is taken as being accurately observed by the witnesses (and I have no reason to doubt this), it means that an advanced, levitating piloted craft – not part of any fleet of conventional aircraft - hovered five feet above the road in Todmorden, Lancashire on 28th November 1980 and it had definite physical effects on the ground – and on the witness.

Chapter Conclusions

For me, the Travis Walton case and the Robert Taylor case are enough evidence to show that extraterrestrial craft have physically interacted with humans. In Walton's case, I can only conclude he was taken aboard and flown "elsewhere." In Robert Taylor's case, it appears there was an attempt to examine him or incapacitate him or take him aboard, but using some type of remote-controlled devices.

In Godfrey's case, it appears he was taken aboard the craft, but unlike Walton, he has no conscious memory of this happening.

12. Leah Haley and Stan Romanek

Leah Haley



In the 1990s, Leah Haley became quite a well-known figure in the UFO/ET community, as she reported multiple alien abduction experiences in her book “[Lost Was the Key](#).”³²⁰ Not only did she have memories, she had marks on her body, as do many other abductees. However, she then later re-evaluated what she had experienced and considered herself to

be a victim of MKULTRA type operations/experiments and she wrote about this in another book published in 2003 called “[Unlocking Alien Closets: Abductions, Mind Control and Spirituality](#).”³²¹

Her story is recounted in [an interesting interview by Jack Brewer, which was posted on his blog in September 2011](#)³²². On 18 May 2004, Haley gave a presentation about her case at MUFON LA.³²³

Haley’s case is similar to that of other abductees in that there are some strange circumstances associated with them. She reported that she had had UFO sightings from an early age. Some of these experiences involved her sister. Haley reported that her first husband was in the US military. In 1973, Haley was offered work on a military base – not by her husband, but by a total stranger. At the time, she was working in a “dime store.” She accepted the (civilian) role and she worked as a Teacher’s Aid – at Laurel Bay base, South Carolina.

In her 2004 presentation, Haley showed photographic evidence of physical marks on her body and described an episode where a helicopter hovered over her home, following an unsettling experience in the night. The helicopter was witnessed by her husband, Mark Davenport (who died of cancer in 2008). She also described multiple encounters with beings who performed medical procedures on her – even extracting ova from her abdomen. She also reported, in common with other abductees, being on a ship and encountering other abductees. She reported that these other abductees were able to recognise each other.

Haley also reported that in one of her abduction experiences, she encountered someone who wore an alien costume - and she then began to feel that this was to disguise the true perpetrators of the atrocities being committed against her. Following her own research, conducted over several years, she learned of the similarity of her own experiences to those recounted by victims of the MKULTRA (CIA) Mind Control projects. After quite some time, she identified a person she called “Bulldog” who was involved in Mind Control projects. She found a photograph of him and Haley was able to corroborate the description of this person given by other abductees. Haley reported that

she felt she had been attacked with a “Sticky Shocker” device, [due to the puncture marks on her body](#)³²⁴.

For a time, Leah Haley lived in Florida and so she began some investigations into the [1987-1990 Gulf UFO Breeze events](#)³²⁵, where many residents reported sightings and some took photos and video clips. Haley suspected that there was an Underwater Base – possibly in the Pensacola area—when she was living in that area. During the period she was investigating her own experiences, she contacted well-known (in the UFO/ET field) abduction researcher and author [Budd Hopkins](#)³²⁶ and [he referred her to a Hypnotist called John Carpenter](#)³²⁷. However, Haley came to regret him being involved with her case, because he later sold many case files to Robert Bigelow (of NIDS), of all people! [A series of articles by researcher Jack Brewer](#)³²⁸ – published on his “UFO Trail” Blog analyse Haley’s case in some detail. Brewer concludes that Haley was manipulated by people and groups connected with MUFON. [He recounts how Haley got into contact with people like Lieutenant Colonel Donald Ware, USAF, Retired](#)³²⁹. Brewer argues that there was an objective to promote the idea – primarily developed during John Carpenter’s sessions of hypnosis with Haley – that Haley had been involved in an incident where an alien craft, aboard which she was abducted, was then shot down and US Military Personnel were involved in its recovery. Additionally he shows that there was a reference to the aliens who abducted Haley being from Sirius – which he found was odd, because [an MKULTRA victim named Martti Koski also referred to aliens from Sirius in research published by Martin Cannon](#)³³⁰. Brewer, essentially, points out that there seemed to be an agenda to promote the aliens being involved – perhaps as a cover for the Mind Control experiments of which Haley had been a part.

Conclusion

Haley is a truthful person and witness. Her case seems to be important in considering possible links between covert mind control programmes, secret military bases and UFO and abduction lore. We will continue and explore these areas further.

Stan Romanek



The case of Stan Romanek seems to be quite complicated and long-running and only seems to have received limited or sporadic exposure – compared to, for example, the cases of Travis Walton or Betty and Barney Hill. Some people think he is just a faker, due to certain events that transpired in 2014. Also, in 2017, things seemed to take a turn for the worst when he was convicted of a crime (see below). Perhaps there is more to his case than at first seems obvious.

I first heard of Romanek in 2003 or 2004, quite soon

after I had come across the Disclosure Project. I heard a few interviews with him³³¹ and he seemed quite genuine³³² to me. A summary of Romanek's case was hosted on a website owned by a researcher called Neil Slade³³³. (I will talk a little more about Mr Slade later.) I remember that, at the time, I saved the pages on Neil Slade's website and eventually included them in a set of "web captures" which sampled and summarised what I had found in the first year of my ongoing research. I put these "web captures" on a self-running CD, for those that didn't have broadband internet connections at the time (this was in the early days of Broadband Internet – when most people in the UK were still using dial-up. Also, wireless and high-speed mobile internet connections were still rare). I later re-posted the contents of this CD online, as a self-contained website³³⁴.

Experiences

Romanek described a mixture of paranormal experiences and UFO experiences. Unusually for these types of cases, he had videoed two objects that had followed him, on different occasions – one in broad daylight and one at night time. Also unusual was that Stan had multiple witnesses to - and photographic evidence of - his experiences. It all seemed very compelling to me. I encourage you to study the evidence for yourself, by visiting an archived version of Neil Slade's website (referenced above).³³⁵ You can also read Stan Romanek's books "Messages" (2009)³³⁵, "The Orion Regressions" (2011)³³⁶ and "Answers" (2012)³³⁷ to learn more of his experiences. 2013 saw the release of a well-made documentary film about Stan Romanek and his encounters.³³⁸

Below, I have included a portion of Stan Romanek's own account³³⁹ from about 2003, which he stated was a summary of many events.

Romanek reported:



Still from video of object filmed by Romanek on 27 Dec 2000

While living in Colorado on December 27, 2000 at about 11:30 AM, I drove up to the mountains to video tape the scenery to show my girlfriend. At the time, she was living in Nebraska. As I was driving to my destination, I noticed the traffic had slowed and everyone was looking off to my left. As I turned my head to see what they were looking at, I noticed something hovering above the power lines. When I realized what it was, I got a little scared and hit the gas. I then noticed it seemed to be passing my car. I then grabbed my video camera and pulled over. As I did, it straightened up and accelerated so fast, it made a popping noise. It stopped at about 1000 feet. I got it on tape.³⁴⁰ But from that point

on, my life has been a nightmare. It seemed that whatever happened must have affected me, or my van because now, birds started running into my car. To date, there have been 44 birds that have hit my car, while I was driving. It

also seemed to have an effect on anything electrical. Computers, light bulbs - the list goes on.

Romanek goes on to recount details of two separate UFO sightings he had in September 2001. On the first occasion, he was with a group driving back from Pennsylvania and he states a UFO, which they observed through binoculars, followed them for several hours. On the second occasion, a big pulsating red sphere floated about 500 feet above his place of work. It left, then returned after he closed up the place and it seemed to follow him home. He continues:

When I got home, I ran upstairs and got my camera and taped it. A bunch of us were outside watching this thing. The next morning, I woke up and found I had gaping wounds in my back, and had the hair and skin rubbed off my wrists. The strange thing was, it didn't hurt and [it] healed really fast. I also remembered that I had a bad dream that night.

He said he saw the same object again a few days later.

On September 22, 2001, I was invited to an astronomy party at a place called Daniel's Park. It was dark and as I was driving up to the park, I noticed that the surrounding area was blinking red. I looked to see if I had left my blinker on, but I had not. Then, I noticed it. It was a lot closer this time. As I got to the top of the hill, it turned left and flew right over everyone that was up there for the party. There were a lot of scared people up there after that. Whatever this thing was, it was pretty bold and didn't seem to care what or who saw it.

The next time I saw the object it was the big one! On September 30th. I had just got off work and was coming home from getting gas for my van. It was in the middle of Lakewood, Colorado... I saw a beam of light hit the ground next to my van, and then sweep across the van. I thought it was a police helicopter, so I rolled down my window and waved at whatever it was beaming me then.

I noticed all the traffic had stopped and as I drove through the intersection people, were leaning out the windows and were staring at me! There it was again - this time I was mad and tried to chase it. As I did, it shot off right over a park, where a bunch of people were having a party. I got out my camera and got some real good shots of it so did the people at the park³⁴¹. We watched it dart off to the right then stop. We then watched as the thing went in to a cloud and create a flash or some kind of lightning, but no thunder.

Romanek then describes circumstances and situations very similar to those described by Leah Haley and others.

On November 18, 2002 at 3:00 in the morning I woke up outside - in only my shorts. I was kneeling by a tree, throwing up. When I tried to get back into the house the doors were locked. I went to the bedroom window and woke up my wife to let me in. When she did, she immediately noticed that once again, there were opened wounds in my back and that I was also tightly grasping something in my hand! I would later find out that I got a broken rib from this experience!

On Neil Slade's pages, Romanek shows photos of his wounds and of the objects he was holding.³³⁹ This seemed to be a crushed stone or a collection of small stones, which he later had analysed. Also, there was a strange circle in

the grass outside his house, which he photographed. A friend tested this with an EMF detector and found that it was causing unusual readings.

In the postings on Neil Slade's site (referenced above), Romanek alludes to being abducted, but does not openly state that he was, indeed, abducted.

As with Haley, we find a military connection in his immediate family. In Romanek's "Answers" book, in chapter 7 he writes:

For one, I was a military child born in December 1962. For another, I don't look like anyone in my family. But there's more...

My parents' unrelenting attempts to influence me to join the military as a young man has a new significance for me today. I learned through Sherman's book [Dan Sherman – "Above Black"] that these genetically altered children generally entered the military to learn how to better use their intuitive communication abilities or psychic abilities.

Intuition and ESP

The reference to [Dan Sherman's "Above Black" book is interesting](#)³⁴². In this book, Sherman claims that he was working in the military on "Project Preserve Destiny" (PPD). Sherman claims he had been trained as an "Intuitive Communicator" – and, further, that he had been "genetically altered" to enhance his abilities in telepathic communication. He said that he had been "steered" into a military career – all as part of a long-term plan, which was probably, therefore, all part of PPD. It's a very interesting book and Sherman seems to be telling the truth. (When I met Sherman in 2012, he did not seem to realise what really happened on 9/11 and felt that "terrorists" were really "an issue." Why do smart people – even those with apparent psychic abilities – not know the truth about 9/11?)

Sherman's "Above Black" book, and chapter 7 of Romanek's "Answers" book, both discuss similar ESP-related themes:

Since my first abduction, I also seem to have gained some slight extra-sensory abilities, both mentally and physically. In what I call spontaneous knowingness, I am able to envision or understand a problem or set of circumstances in a most profound way—far beyond what we normally refer to as intuition. I also am able to physically feel other people's pain when I get near them and can often alleviate the pain they are experiencing by touching them. My hands get exceptionally hot, as if energy from some other source is working through me.

Is this all just sheer coincidence, or did my father keep crucial information from me? Or, is my father altogether blissfully unaware of the part he played?

Predictions

In chapter 2 of his "Answers" book, Romanek relates how, in the autumn of 2004, he wrote out a list of predictions of future events and then put them in an envelope and posted them to himself, so that the envelope could remain sealed, with a postmark on it (to prove the date he made these predictions). It seems that this wasn't the first time he had made predictions. In January 2002,

he appeared on the US late-night talk show “Coast to Coast” and [the synopsis of the show read](#):³⁴³

Working with therapist Deborah Lindemann, he retrieved memories of encounters with humanoid-like beings that he calls “the possum people.” He described them as having huge eyes, straggly hair and long faces. They showed him visions of catastrophic Earth events that included 600 mph winds and major explosions, which he was told would occur in December of this year.

Clearly, this prediction was hopelessly wrong. (If you read alien abductee/contactee accounts, a common theme that recurs is one of massive “earth changes” – involving catastrophes of various kinds. They also state that humans are destroying their environment and that this isn’t a good idea. We will discuss more about that later.)

In chapter 9 of his “Answers” book, Romanek relates how the envelope was opened in the company of others and he goes through his list of predictions, written down on 14 October 2004 and reviewed on 28 February 2009. Whilst he appears to have a good selection of correct predications, some of these seem a little generic, but others, particularly to do with his own experiences, seem more specific. He makes several references to “first contact” (with ET’s) but then glosses over how this hasn’t really happened. The biggest “miss” he had was that he predicted that the Yellowstone volcano would erupt in 2011 – this has not happened. He predicted “first contact” (whatever that means) in 2012 – this has also not really happened, as there has still been no official confirmation of issues we are discussing in this book! Again, we see anomalies such as references to “global warming” in his 14th prediction “14. Late spring 2009, winds start because of global warming!” This is bogus (as I discuss in [“Climate Change and Global Warming: Exposed](#)”³⁴⁴.) So, why are beings with higher abilities than Romanek telling him lies or not correcting him on something which is provably bogus?

Alien at The Window

One of the predictions that Romanek made in 2004 was regarding the notion that he would become famous in 2008 – it seems that this came to pass when Romanek published a very strange [video – apparently showing an alien peeping in through his window, at night](#)³⁴⁵! He reproduces a still from this video in chapter 9 of his “Messages” book. This video was shown [on Larry King’s CNN programme in 2008 – when Romanek was accompanied by Jeff Peckman](#)³⁴⁶ – a well-known figure in local politics in the Denver area at the time. Peckman apparently had heard about Romanek’s experiences and seen the evidence and this made him create the “Extraterrestrial Affairs Commission” for the city of Denver. This video strikes me as very unusual and I can’t immediately see any evidence of fakery. Romanek’s testimony about it seems genuine.

Faking for Protection?

Followers of Romanek's case were perhaps disappointed in 2014, when it seemed that evidence had emerged that Romanek was hoaxing at least some of his experiences. [In a video/skype interview with an experiencer called Peter Maxwell-Slattery, two objects \(a pen and a USB memory stick\) were seen to fly across the field of view during the interview, at which Romanek expresses surprise.](#)³⁴⁷

It then seemed much easier to dismiss Romanek as a fraud – but, [a July 2015 face-to-face interview between Maxwell-Slattery and Romanek](#)³⁴⁸ revealed that Romanek had acted this way to protect himself. Maxwell-Slattery confirms that while visiting Romanek, strange events repeatedly happened and he understood that, in the “2014 fakery video,” Romanek had essentially acted to protect himself. Romanek reported that he had been repeatedly threatened. In the 2015 Maxwell Slattery video, it is revealed in January 2014, one of Romanek's friends, Richard, suddenly died and soon after this, Romanek received a threat that alluded to the death of his friend. Romanek was told to then discredit himself or “suffer the worst.” The threat included specific information about what his friends were doing and so Romanek took the threat very seriously. Romanek also reported that he was assaulted.

In the 2015 interview, Lisa Romanek (Stan's wife) also speaks and points out that they know they are being watched and thus they would be “silly” to do anything illegal.

Images of Child Pornography - Charges

Also covered in the 2015 Maxwell-Slattery interview were the accusations that Romanek had (in 2013) been charged with possession of pornographic images of children. Romanek vehemently denies these charges. [The long-running case has been documented on the UFO Chronicles Website](#)³⁴⁹.

[Sadly for Romanek, in 2017, he was convicted of the charge of possession of child pornography images, though he was found not guilty of other related charges.](#)³⁵⁰

Before drawing some conclusions about the Romanek case, I would first like to mention a little more about...

Neil Slade and Stan Romanek

As I mentioned above, I first became aware of Romanek's case via Neil Slade's website. Slade also appeared with Romanek on [“Coast to Coast” back in 2002](#)³⁴³, when they were discussing the UFO footage that Romanek had captured back then. However, it seems [Slade has since distanced himself from the case, implying that the object in Romanek's video still \(shown earlier in this chapter\) was a weather balloon](#)³⁵¹...

See below for previous opinions - now changed after speaking with NCAR in Boulder. Yesterday, we followed up our previous day's "UFO" sighting- just for the hell of it. We went to the same location at the same time, and to our complete astonishment we again saw the same "silver" dot in the sky, rise

over us at the exact same time of the day. The location of the object was slightly different, and its path was different. It was also smaller - perhaps farther away. HOWEVER, we came prepared - we brought a telescope with us. Although difficult to track, I managed to get it smack in the center of the field of view for at least a few moments - and what I saw was a PERFECTLY ROUND "silver" pearl GLOBE.

Slade particularly caught my interest because he was also in the [Scholars for 9/11 Truth Group](#)³⁵², formed in 2006 – which I wrote about extensively in “9/11 Finding the Truth”³⁵³. Neil Slade’s main area of interest is “Brain Research”³⁵⁴. In the 1980s, he became involved with the “remnants” of T.D. Lingo’s [Brain Research and Development Laboratory](#)³⁵⁵. Lingo was doing experiments between the 1950s and 1970s in a community he built on Laughing Coyote Mountain, Colorado. Slade quotes Lingo thus:

For the next 30 years I dedicated myself totally to exploring behavior from the perspective of the human brain. My staff and I looked at every available bit of scientific research and philosophic/religious literature on the subject. We ran our own short- and long-term experiments with 309 test subjects. Now, up here, this environment of rugged mountain wilderness provides a total focus into the self that never can be replicated in any city, with all the noise and distractions. Up here, there’s no electricity, no TV, or movies, no four lane highways to get away from it all. You ARE away from it all!

Though I have not taken the time to dig out the correspondence I had with Slade some years ago, I remember he asked me to remove some of my web pages which were copies of his (fair enough), so I wrote back to him and apologised and I deleted them. Later correspondence revealed that Slade was what I call a “thermite sniffer” in relation to 9/11 evidence and he had no apparent interest in learning the truth about the WTC destruction, as was being presented in the period 2007 – 2012 by Dr Judy Wood (see all my other writing on this). A recent search of my email revealed a message from him from 2012, which read thus:

----- Original Message -----
From: Neil Slade <ns@neilslade.com³⁵⁶>
To: ad.johnson@ntlworld.com
Date: 14 February 2012 at 19:05
Subject: Unbelievable.
Now I’ve seen everything.
http://www.checktheevidence.co.uk/cms/index.php?option=com_content&task=view&id=345&Itemid=62
The FAUL documentary was SATIRE, in the same manner of *The Rutles* by Eric Idle. In addition to that, Paul McCartney is in my extended circle of friends. Did you say you were a member of my brain newsletter? That you were a serious researcher? Wow. You really made my day today.
Good luck in becoming the next David Icke.

Here Slade, gently mocks me, without addressing any of the available evidence that is in the article he referenced. I can only guess that the “FAUL

documentary” he is referring to is probably the [“Paul McCartney Really is Dead: The Last Testament Of George Harrison”](#)³⁵⁷ which is indeed a kind of “spoof,” meant to distract from the anomalies relating to Paul McCartney, highlighted in the article I wrote in 2012. I did not reference said documentary at all. Slade couldn’t even be bothered to check his own mailing list to see if I was on it (I wasn’t) and so just made an assumption. (Is that “good research?”)

Whilst it may seem too tangential for me to mention all this here, and perhaps I am making apparent connections where none exist, but I couldn’t help thinking it was odd when Slade:

- Presented Romanek’s case in the early 2000’s
- Got involved before that in “Brain Research”
- Was in the 9/11 Scholars Group
- Wouldn’t (apparently) accept what really happened to the WTC on 9/11
- Randomly contacted me about the probable replacement of Paul McCartney - to criticise something I didn’t mention.

Does Slade have intelligence service connections, such that he makes it his business to “sniff around” sensitive issues, or is it just a vague interest of his, that he doesn’t devote as much time to as I do...?

Connection to Source

In the Epilogue of Romanek’s “Answers” book, he writes that he is a messenger, not a preacher or teacher:

*As a member of the human race, you have within you the ability to change quantum reality naturally. In short, you can manifest what you believe! More than that, humans **have a direct connection to source**; some call it the Oneness, or God. In any case it is an unimagined consciousness.*

He then goes on to suggest that 2012 would have been a “new beginning.” According to some people, some of the alien races don’t have this “connection to source” - they want to use humans to acquire this connection. This theme has also been [written about by Nigel Kerner in his book “Song of the Greys,” published in 1999.](#)³⁵⁸ Is this where those discussing this issue with Romanek got the idea?

Another of Romanek’s books is a set of transcripts of regression/hypnotism sessions called [“The Orion Regressions”](#)³⁵⁹. These sessions were conducted with Dr Leo Sprinkle. I have not read this book, but two of the comments echoes my own thoughts on many other contactee cases, some of which we’ve already discussed. [Reader Keith gives a 3-star review and says](#)³⁶⁰:

While reading this book, I became annoyed for the people participating in the regressions, that the entity identified as Grampa seemed only willing to say in answer to questions put to it, “That is not important “.

[Mr.S.R.Pidgley also gives a 3-star review, stating](#)³⁶¹:

Answers posed during regression were frustratingly indirect and somewhat repetitive. Otherwise bog-standard dialogue and not as informative as I would have liked.

Stan Romanek Case – Analysis

My overriding impression of Stan Romanek is that he is an honest person and his experiences are real. We must then consider what his experiences are caused by. I would not rule out the idea that he is indeed in contact with extra-terrestrial beings of some kind. Perhaps he is indeed part of some alien hybridisation programme, I really cannot be sure.

However, what also seems clear is that his life has been the target of extreme forms of interference – from physical assault to psychological attacks and possibly even psychotronic attack. I cannot help wondering if he is yet another victim of MKULTRA- type techniques/technologies (as well as whatever else has happened to him). I find it an unusual coincidence that one of the people that was involved with Romanek in the early days of his experiences was Neil Slade – who had a strong interest in “Brain Research” – even though Slade, on his website, never seemed to relate Romanek’s odd experiences to things like Mind Control or [Psychotronics](#)³⁶². Why did Slade dismiss Romanek’s case based on one “weather balloon” image (which looked nothing like Romanek’s UFO images)?

I think the truth about Romanek’s ESP abilities and his predictions has been muddled up and obfuscated. His “big catastrophe” predictions were clearly inaccurate or just wrong, but other predictions do, taken at face value, seem to have been more accurate. If he has indeed been abducted, it seems difficult to know whether this was by paramilitary or black ops groups or by ET’s – or both. Due to the attacks on him and those around him, he has little if any chance of evaluating his own experiences in a truly dispassionate and rational way. Indeed, the prevention of this sort of evaluation is probably one of the goals of the ongoing harassment that Stan – and other abductees and contactees – have been subject to.

In his “Answers” book, a fair amount of information is delivered through a figure called “Lazarus” and this includes unverifiable quotes from Dan Burisch (who had come onto the scene in the time Romanek’s book was written) about greys coming here from two future time periods. The “Looking Glass” time travel technology is discussed and related to the machine shown in the 1997 film “Contact” – the machine that was used to send Jodie Foster’s character on a trip to another dimension. According to Lazarus in chapter 12 of Romanek’s “Answers” book:

They also used heavy materials for the gravity repulsion matter, and a new element obtained from the extraterrestrials called Element 115.”

Element 115 was described in the Bob Lazar story as being the substance that powered the reactor of the ship he saw or was working on. I think this is disinformation in both contexts (see the [“Finding the Secret Space Programme”](#)⁴² (FSSP) – book for more information). In Lazarus’ claim above,

what exactly is “gravity repulsion matter,” I wonder...? The evidence in the FSSP book tends to imply gravity is influenced by fluctuating electric and magnetic fields – not by types of matter.

Also mentioned by “Lazarus,” the unverifiable story from Andrew D Basiago about the “chronovisor” (a device that allowed the user to look into the future or the past) is included. A reference is also made to David Icke and his writings about Reptilian beings. Topics relating to the New World Order are also mentioned and are worth thinking about, if you’re not already familiar with them. Again, Romanek doesn’t really offer his own perspective on this and just responds with some surprise or incredulity to statements made by Lazarus.

The information in Romanek’s book about alien hybrid children (of his own and of people he knows) is interesting – but difficult to take in. Also, Romanek describes an episode where his hybrid daughter “appears” in his garden and then she calls him on the phone. It is bizarre behaviour, to say the least. However, his account mentions multiple witnesses to the girl, so I find it harder to assume this story is untrue.

Romanek touches on many other things and says that one of the aliens that communicated with him was an “Elohim³⁶³.” Of course many authors, including Zechariah Sitchin, have written about the Elohim as a race of aliens who interacted with humans in stories of the Christian Bible’s Old Testament. I don’t know what to make of this aspect of the story – I neither believe it, nor do I disbelieve it!

The discussion of timelines seems to be based too much on information that was circulating around the time Romanek’s “Answers” book was written and there doesn’t seem to be any additional new or complimentary information.

Then we have the ET’s from Orion – which also crop up in other stories but we’re not given any strong evidence they really are from there.

The stories of the hybrid children are interesting and echo what many other abductees recount. However, their weird behaviour that Romanek describes – random appearances in his garden and then at a conference hundreds of miles away, and sporadic, brief and disconcerting phone calls – just makes no sense in the context of the ET’s trying to bring us some kind of enlightenment.

Are the Black Ops groups just ruining everything for Romanek (and the rest of us)? How can we know if they’re “running the whole show” or just interfering in the interactions between humans and aliens?

For further information, you can read Stan Romanek’s books or watch the videos – referenced earlier in this chapter.

Abductions – Further Thoughts

A running theme through Romanek’s book is that he is attempting to deliver information that will help the rest of us to become more enlightened and there is an implicit assumption that the ET’s he is in communication with are more enlightened than us. However, I find this characterisation as puzzling in

Romanek's description as it is with other contactees who have apparently suffered physical abuse.

These ET's don't really fully explain why they abduct people, against their will, physically abuse them, affect their memory and traumatise them.

Imagine that I broke into your house, knocked you unconscious, took you out into my van, injected you with something and, say, then left you half naked in your garden and then I left you a telephone message saying, "I did it to enlighten you and the rest of humanity!" Would you think this was sufficient moral justification for my actions? In the rest of our society, it is usual to ask for permission to do such things and we would usually "opt out" of such physical and mental abuse, given a choice.

That is a longish way of saying "whoever is doing this sort of thing to Romanek and others is probably not enlightened. They are dishonest, cowardly, disrespectful and unpleasant." An enlightened way of doing this would be to communicate and build trust and tell us what actually is going on – openly.

Another moralistic idea that sometimes comes up within many contactee accounts is that of "forgiving" and "forgiveness." This is all fine and dandy and personally, I try to be forgiving in all things. There is a paradox here, though. If we forgive ongoing repeated deception and abuse, how do we learn the truth and become enlightened?

I am given to wonder that if it is Black Ops/nefarious earth-based groups doing these abductions, why don't the genuine ET's tell the contactees this? Why don't they name names? If the ET's have advanced technologies at their disposal, why aren't they "supporting" the contactees more by giving them useful, timely and truthful information about who is doing what to whom?

When I carefully consider this line of thinking, I can only conclude that Leah Haley is right – any benign or enlightened alien involvement in these cases is minimal.

13. Budd Hopkins and A Bizarre New York City Abduction Case

Budd Hopkins and Perez de Cuellar



A portrait of Budd Hopkins, taken in Rome, Italy, 1997. Photographer: Carol Rainey

Budd Hopkins (1931-2011) was an, artist of some note, who began to do research into the alien abduction phenomenon – following a daylight sighting he had near Truro, Massachusetts in 1964.³⁶⁴ His first investigation was into a UFO landing incident that took place in North Hudson Park, New Jersey on 12 January 1975.³⁶⁵ He authored several books on the abduction phenomenon³⁶⁶ and gave many, many lectures and interviews over a 30-year period. He, like many other researchers, concluded that at least part of the abduction phenomenon did involve some group of entities extracting genetic material from experiencers to use in some type of genetics testing and/or breeding programme.

He eventually set up a “support group” called “The Intruders Foundation” to help those dealing with these traumatic experiences (whatever the physical reality of them might be in each case.)

Here, I want to focus on what is perhaps Hopkin’s most bizarre case, which he wrote up in his 1997 book “Witnessed: The True Story of the Brooklyn Bridge UFO Abductions”³⁶⁷. I haven’t heard that much discussion of this case within the UFO community, although such discussion perhaps occurred in between 1997 and 2003 – the years immediately before I was “drawn back” into this subject.

Hopkins can be seen in a very short YouTube clip, filmed prior to 9/11, giving a quick outline of the case.³⁶⁸ The incident was alleged to have involved Javier Perez de Cuellar, the former Secretary General of the United Nations³⁶⁹. Though Hopkins does not, apparently, name de Cuellar in the “Witnessed” book, he alleges that the primary witness in this weirdest of abduction cases, Linda Napolitano, received letters from Perez de Cuellar during the course of the investigation. If the incident really did occur (and a proportion of the testimonial evidence seems fairly credible to me), then it is yet another indication that we cannot really expect any truthful official/government disclosure about the matters of UFOs and aliens.

The event centres around a Linda (Cortile) Napolitano, New York resident who came forward with an account of an abduction, of herself - *and her son* - by Grey aliens at about 3 a.m. on 30 November 1989, from her apartment. This all took place quite near the offices of the New York Post - near 210 South St, Manhattan. Hopkins was investigating this case and during this

investigation, he received letters from two witnesses known as Richard and Dan. He was doubtful about their claims at first, but they were able to corroborate certain details of Linda Napolitano's case that surprised him. Some details about the case are [written up by B J Booth on the UFO Casebook website](#)³⁷⁰, where it is stated that "Dan" and "Richard" were actually working as bodyguards for Perez de Cuellar. They sent Hopkins a description of what they saw and this tallied with Napolitano's description, to some degree (as did the timing). The Booth article quotes "Richard" thus:

There was an oval-shaped object hovering over the top of the apartment building two or three blocks up from where we sat.

"We didn't know where it came from. It happened too fast. Its lights turned from a bright reddish orange to a whitish blue coming out of the bottom. Green lights rotated round the edge of the saucer. A little girl or woman wearing a white gown sailed out of the window in a fetal position - and then stood in mid-air in this beam of light.

I could see three of the ugliest creatures I ever saw. I don't know what they were. They weren't human.

Their heads were out of proportion, very large heads with no hair. Those buggers were escorting her into the craft. My partner screamed, 'We have got to get them.' We tried to get out of the car but couldn't. After the woman was escorted in, the oval turned reddish orange again and whisked off.

The story takes a bizarre twist when it is claimed that on April 29, 1991, "Dan" and "Richard" kidnapped Napolitano, bundled her into their car in broad daylight and interrogated her for three hours, apparently because they thought she had some kind of strange ability and that she herself was partly responsible for what they had witnessed!

Incredible though this story sounds, more witnesses seemed to come forward. [A further posting on the UFO Casebook website gives an account by Yancy Spence](#)³⁷¹ – a van delivery driver/worker for the New York Post. [A version of this posting/article appeared in the October/November 2002 edition of UFO Magazine](#)³⁷².

Spence gives an account which suggests that Richard and Dan may have been telling the truth when they said they were in a limousine in NYC at the time of the abduction... Spence describes how he, and many other witnesses seemed to have had their memory and recall of the incident affected, in some bizarre way, and it was only sometime later that he remembered what had really happened. He wrote:

About a dozen people remember the procession of stretch limos that was parked on South Street (where the New York Post is located). These obviously belonged to some very important people. I, myself, remember the ugly colored Rolls Royce parked at the end of the little pedestrian island that faces the loading bays for the delivery trucks.... The four men I tracked down all remembered the Rolls and line of more than a dozen dark limos. One of these men was Steve Dunleavy, Investigative Reporter, who remembers the limos but not the Rolls.

That morning, at 2:30 AM, I was upstairs in the South Street Diner, which is on the corner of South Street and Catherine Slip. I was told to report in early for my route, which didn't go out until 4:00 AM...

Spence describes driving across the bridge in light traffic when his vehicles power suddenly cut out – as did that of vehicles behind him. At this point, he looked out and saw...

...a beam of red light playing across the nearby buildings. The light changed to a greenish-white color and became pencil thin as it traveled across the building facades. Whoever was outside at the time had to see it, because this beam of light was the only power source working in the blackout. One of my thoughts was that this must be some kind of laser test that the Brooklyn Navy Yard was conducting, but the source of the light stopped before the East River.

Spence reported that the beam ended up on the Knickerbocker Apartment Complex, on Cherry Street and it was pointing up to the top floor of the centre building which had an exposed water tank, and it was focused on the bottom half of a double-pane window. Moments later, the sky lit up and a flash also illuminated the bridges' superstructure. Spence continues:

I saw maybe two-dozen people who were now outside of their stalled vehicles ... Some of them were screaming and looked like crazed birds locked in a cage, as others pointed back toward Knickerbocker. It was surreal and it scared the hell out of me.

Spence then describes how he witnessed four balls, ascending the Knickerbocker building in formation...

They were tumbling, and as they got closer to the source of the light, the balls opened up like blooming flowers. I could see that there were three gray aliens in dark jumpsuits in a triangular formation surrounding an angelic-looking, dark-haired woman in a white gown. Her long hair flowed out in all directions, as if in a pool of water. They all looked like they were being pulled up by their mid-sections. I thought, at the time, that each body was being lifted on cables and that they were making a movie.

As his recall improved, he remembered seeing the spacecraft.

It was saucer-shaped, and the bottom half was outer space black with angled sections like a stealth fighter. The saucers top half was mushroom shaped – very “organic” and smooth with a gray metallic color.

He describes other details about the craft and then reports:

The outside of the dome turned a bright red. And then the saucer and its occupants just disappeared.

Afterwards, I remember everyone casually getting back into her or his vehicle, starting them up, then continuing their drive off the bridge. They were all probably thinking the same thing I was, that whatever it was we had just seen would be on the news or in the papers. But, by the time I went 10 feet, the entire incident was forgotten.

It was just after this event that he arrived back at the New York Post Offices - only six blocks from the bridge. There he saw an “ugly Rolls Royce” parked across from the diner. Limos were parked on both sides of South Street,

blocking a corner and this prevented newspaper delivery drivers from backing up their trucks for picking up the 4:00 AM edition.

Spence reported that Budd Hopkins visited him in 2000 (three years after Hopkins' "Witness" book had been published) and Spence gave him the details of the story, along with the name of another driver that Spence knew who could corroborate the story. Spence mentioned someone called "Bob" who also remembered the event and he persuaded Bob to talk to Budd Hopkins. In his article, Spence also challenges sceptics to disprove his story. [In 2004, UFO researcher and author Richard Dolan also interviewed Spence and other witnesses and had no reason to doubt the validity of their testimony.](#)³⁷³

Dr Steven Greer and False Flag Abductions

Another place where the story is discussed is on Grant Cameron's "Presidential UFO" website. [In an article about former CIA Director George Bush's presidency, the Napolitano case is brought up.](#)²¹ (Cameron makes the case, based on some of his public statements, that Bush snr. knew quite a lot about the UFO cover up. Some researchers go further than Cameron and claim that Bush was a member of the MJ-12 group. Folks might also consider what David Icke publicly stated about George HW Bush on several occasions.) In Cameron's Bush article, referencing the 1989 – 1993 period (in which the Napolitano abduction took place), Cameron quotes Dr Steven Greer from a 1999 interview with Art Bell:

The power to abduct is according to Greer the ultimate "trump card" to control the President or anyone else in power from revealing the UFO secret. "It can be made very clear to them," Greer told Art Bell, "that if they don't play along, the trump card can be played."

In other words, Greer contends that it was a military Black Operation that was in progress in New York and that Perez de Cuellar was *also* abducted – along with Linda Napolitano and her son. Cameron's article states:

After further investigation, Hopkins determined that Perez de Cuellar was not a witness, but had been abducted as well. This fact was confirmed by Linda's son, who identified the Secretary General from twenty photos of men shown to him by Hopkins, as the man who was with him and comforted him during the abduction. Hopkins contacted Perez de Cuellar in person about the letters he had sent to Linda and himself, and de Cuellar didn't deny his involvement.

[Greer repeated similar comments about the reason for the abduction in a lecture he gave on 21 November 2015](#)³⁷⁴. He also stated where he got the information about Perez de Cuellar's involvement in the abduction. He described how he had a meeting, in New York with Prince Hans Adam von Lichtenstein. Greer makes some interesting introductory remarks in this section, stating:

*Lichtenstein is a big banking empire and... kind of... **they funded a lot of Adolf Hitler's work** and the Crown Prince is their king - so this is a man that I've met with and known for a number of years...*

(and what exactly was Hitler's "work"...?) Greer then shows a letter from von Lichtenstein indicating that they met at the Four Seasons Hotel, New York on 15 July 1994. Greer goes on to explain that von Lichtenstein told him that de Cuellar abduction incident happened because there was an effort underway involving Regan, Mikhail Gorbachev, de Cuellar and others to disclose the truth about UFO/extra-terrestrial matters. (This, of course, is what Greer was trying to do - and tried to do in 2001.) However, von Lichtenstein also told Greer that the *aliens* did not want this disclosure to happen and therefore they threatened to "abduct" any world leaders who went along with this initiative. von Lichtenstein further told Greer that de Cuellar was taken aboard the craft and threatened by the aliens.

Greer then relates how he told von Lichtenstein that, actually, it was not an ET abduction at all – it was totally a "Military/Black Ops false flag" operation where a "fake enemy" was blamed for something it didn't do – just like the Gulf of Tonkin incident was used to start the Vietnam War and so on. Greer claims he knew this because he eventually tracked down someone who actually worked on the electronics that formed part of the technology that was used in that incident.

This all sounds extremely improbable – not only that a high-status official like Perez de Cuellar was a witness to, or a participant in the events, but that such an incident took place at all. Returning to Grant Cameron's article, he notes:

In checking the Greer version of the de Cuellar abduction, a series of events were uncovered that indicated that the Greer story, no matter how bizarre at first glance, might actually be true. Was there a worldwide plan to release the UFO secret following the collapse of the Soviet Union and the cold war? Was there an effort by someone to stop it? Consider the following:

- 1. On the day of the de Cuellar abduction, George Bush left Washington for Malta and the first post-cold war summit.*
- 2. The evening of the abduction, only hours before the 3 am abduction, Canadian Prime Minister Brian Mulroney was meeting privately with George Bush at the White House. He had just returned from the Soviet Union and a meeting with Gorbachev. His purpose in meeting with Bush was to "brief" him about his meeting with Gorbachev.*
- 3. Rumors have Brian Mulroney in New York City following his visit with Bush. There were apparently five cars in the de Cuellar motorcade, and there is at least one rumor that Mulroney was in the motorcade. Budd Hopkins stated when asked he had never heard about the Canadian Prime Minister being in the motorcade.*
- 4. The de Cuellar motorcade was, according to Richard (one of de Cuellar's secret service agents), heading for the heliport at Governors Island. This island, on the southernmost part of Manhattan, is a U.S. Coast Guard authorized personnel-only complex. The secure complex was the site of the summit meeting held the year before between President Reagan and Gorbachev, along with President-elect Bush.*

[An article by Dr Michael Salla on his "Exopolitics" website includes more details and some analysis of Greer's 2015 statements.](#)³⁷⁵ However, for reasons

I discuss below, and have written about elsewhere, I don't think Greer is being completely honest about what happened here. I think there is another layer to this. Greer makes further remarks about the meeting with von Lichtenstein. At about 2:40:20 into his 2015 lecture, Greer states:

...so he told me that the reason he was funding the abduction groups is that he was convinced that there was an existential threat from outer space. That's been the Sabrosa plan since 1956 and that he wanted people to hate the aliens enough to pay the blood and treasure of World War III and he also wanted it to be eschatological where it would result in the end of the world so that Christ would return and the good folks would go up in a flying saucer...

So, these remarks, according to Greer, are *coming from the King of a country or regime – or power – that funded Adolf Hitler?* What is the *real* story here?

Whilst I have little doubt that Greer met Von Lichtenstein, I have serious questions about Greer's version of what was said. Similar questions arise about Greer's meeting with James Wolsey in 1993. Greer claimed that he had "briefed" Wolsey about the UFO/ET subject. [However, Wolsey stated, following public comments about this by Greer in 1999, that they had simply met at a dinner party](#)³⁷⁶ and there was no "briefing." (This also gives an indication of the sorts of circles of people that Greer was moving in at the time – and he was just an ER Doctor...)

Remember, this meeting took place in 1994 – seven years before Greer brought forward his Disclosure Project "package." One of the points that Dr Michael Salla raises in his article about the de Cuellar incident is that Greer talked about the [implantable chip technology which was described to him by William Pawelec in an interview which took place in 2000 or 2001](#)³⁷⁷. Though it's possible that Greer knew about this in 1994, I somehow doubt it. Also, this meeting with von Lichtenstein took place *three years before* Budd Hopkins' "Witness" book was published. This is also interesting, because in his lecture Greer goes on to state:

That's why he [von Lichtenstein] was putting so much money and providing so much funding to Mack and David Jacobs and, you know, Budd Hopkins and all this... and he eventually told me... he says "I'm going to stop funding John Mack, because he's become too positive about contact and I only want to fund people who are going to put things out there that scare people and make them hate the aliens." he said this...

Greer then goes on to repeat, as he and many others (including myself) the statement that was allegedly made to [Carol Rosin by Nazi War Criminal and Rocket Scientist, Wernher Von Braun](#) about the "last card" being "the extra-terrestrial threat from outer space"³⁷⁸ that according to Greer "does not exist."

Here we have Greer, an ER Doctor telling Hans Adam von Lichtenstein, who is funding John Mack, Budd Hopkins, David Jacobs and "abduction groups" so that people will "hate aliens" (just like they "hate Al Qaida" and "hate ISIS" etc). So, who is actually running the "false flag" operation? Why is Greer – or von Lichtenstein for that matter – not more interested in the truth and

finding out more (and explaining more) about the aliens (whether they are threatening or not)?

Greer rounds off his discussion of this event with a quote from a Nazi War Criminal. *Not only that, but in the very same lecture, following a question from an audience member, Greer refuses to acknowledge the known truth about the most significant false flag event in modern history – 9/11. (Greer would not talk about the destruction of the WTC.*³⁷⁹ As I have said already, I will have a lot more to say about Dr Greer in chapter 23.

In chapter 3 of Greer’s “Hidden Truth, Forbidden Knowledge” book he again discusses creating a false “alien threat:”

...this assessment comes from having interviewed numerous military people inside the organizations dealing with this. I've been told point blank that this has been an ongoing agenda since at least the 1950s. These operations have used something called "alien reproduction vehicles," manufactured by a consortium of companies that include Lockheed Martin, Northrup, SAIC, E-Systems, EG&G and Mitre Corporation (among others). These are man-made anti-gravity devices that we've been using since at least the '50s, along with other powerful electronic weapons systems and "programmed life forms" or PLFs. These are biological, artificial life forms being produced to look a lot like these so-called "greys"—that are not from outer space. They're manufactured in a few facilities, one of them located in the four corners area near Dulce, New Mexico.

In his 2015 lecture, he mentions SAIC ten times – never once does he mention their involvement with the events of 9/11, even in response to a direct question about this.

This whole issue raises another scenario to consider – that the aliens are not exclusively in outer space – some of them are here. They are running their own operations – in agreement with the Bushes, von Lichtenstein and others. It serves not only their purpose to have people in a state of fear and ready to fight war, but it also serves the purpose of genuinely evil people like George H.W. Bush, Adolf Hitler, Bill and Hillary Clinton and all other people like them who are in similar positions of power. Perhaps Perez de Cuellar was some kind of exception and was threatened because he found out more than he was meant to and came to some startling conclusions.

What a shame that so many people follow Greer and think that what he says is all true – when only some of it is, and the rest of what he says is deceptive or misleading – in a way which has been carefully planned by the very interests he is claiming to expose. That is to say, that what he says about the Military Industrial Complex is true and what he says about contacting “good ET’s” is also true. What he says about Wernher Von Braun’s disclosure is true. However, what he (and many others) aren’t telling the truth about is that some of the aliens are working with some humans to deceive us and keep us in a state of general fear and ignorance, so that they can maintain both physical and spiritual power over us. Greer is serving a similar agenda, by misleading us or omitting certain key information from his disclosures and massaging other information.

14. Analysing Alien Abductions

As already noted, the alien abduction phenomenon is extremely complex – and evidence and discussion spans the areas of UFOs/aliens, dreams, military/black ops, hypnosis, mental health, consciousness and out of body experiences, targeting of individuals, implants, hearing strange voices. In this chapter, we shall attempt to examine some of the points in this list.

Alien Implants?

Dr Roger Leir (who passed on in 2014) was a podiatrist who spent many years investigating the phenomenon of alien implants. In the course of several operations, he removed a number of them from people. He could find no point of entry and no inflammatory response in the tissue where these implants were found. He video-recorded the operations he performed and he wrote these up in his book [“Aliens and the Scalpel.”](#)³⁸⁰ In his research, Leir worked with several groups – including Los Alamos National Laboratories and NIDS (National Institute for the Discovery of Science). A [short write up of Leir’s work](#)³⁸¹ by “Janet” includes the following interesting paragraphs:

Leir’s work struck a chord with me, mostly because the description of the objects he discovered appear to match the description of objects recovered from TI [targeted individuals] patients. This suggests that if these objects are truly manufactured (a fact that has yet to be scientifically established, in my opinion), it is an erroneous assumption that Sims and Leir have made that the objects are extra-terrestrial in nature.

The Los Alamos lab simply recommended further testing, and New Mexico Tech concluded that the samples were made up of metal material one could only find on a meteorite.

Not only is there nowhere near enough evidence to suggest that these are “alien” implants, but such an assumption also applies an unnecessary stigma to the phenomena surrounding these strange objects. It’s a stigma which keeps legitimate doctors and researchers from examining these cases more closely, and it keeps most mainstream reporters – wary of anything to do with “aliens” – from exploring these unusual and intriguing cases.

So, is it the case that some people have been covertly implanted, so that they can be tracked and/or influenced remotely? Is an earthly or unearthly agency involved in this?

Dr Karla Turner

Dr Turner died in 1996. [A website memorial to her, and her work, states she was](#)³⁸²:

A scholar and professional educator, she earned a Ph.D. in Old English studies and taught at the university level in Texas for more than ten years. But in 1988, she and her husband and son endured a shocking series of experiences and recollections that forced them to recognize that they were all abductees.

I recommend interested readers study [Dr Karla Turner's 1994 book "Taken: Inside the Alien-Human Agenda."](#)³⁸³ Turner's work is regarded by some as perhaps the most important – and she certainly did an excellent job of illustrating the complexity of the abduction phenomenon – taking into account many scenarios – which she summarises in the first chapter of the book, thus:

An overview of all our experiences, as well as reports of other abductees, shows a much more complex program of activity in the phenomenon than is usually acknowledged. To begin with, the abduction scenario comprises a number of different types of events. On the most immediate level are the physical abductions, in which a person is forcibly removed from the normal environment by 'alien' (in the most generic sense) entities, the person's awareness is altered, and some interaction occurs. Subsequent conscious memories of the event are usually quite incomplete. Only when the event is witnessed by more than one person, or when there are physical marks on the abductee's body-punctures, scoops, patterns of bruises, artificial designs-does the witness usually feel safe in asserting the 'reality' of the encounter.

To complicate matters, many reports show that some interactions occur on a mental rather than a physical level. One type is an artificially induced virtual-reality scenario (VRS), an externally introduced event, that to the witness is practically indistinguishable from objective reality. The person may experience a situation with full sensory input and react with genuine physical and emotional responses, although in 'reality' the person may be lying immobile on an exam table, or sitting attached to some alien apparatus, or even asleep in bed with no outward sign of disturbance.

On pages 133 – 140 she includes tables which show elements common to the different experiences reported by several abductees she interviewed and corresponded with. She also includes a detailed discussion of these tables in the final chapter of the book. One thing I find of great interest is on page 148:

On this last issue, every one of the women have reported seeing other humans present in abduction situations. Amy, Angie, Lisa, Pat and Beth recall experiences that involved military personnel, and in most instances there were aliens working with the humans. Although some of these scenes may have been alien VRS productions, other peripheral activities do indicate actual human involvement. Angie, for instance, was confronted and intimidated by uniformed men in the pickups that pinned her between them on the highway, just hours before she had a military abduction and was threatened about "talking."

Perhaps Turner's researcher was, indeed, "too thorough" and maybe she was getting closer to some very sensitive issues and "treading on toes." [This has been suggested by some \(and I certainly don't rule out that possibility\)](#)³⁸² as the reason she died of Cancer at the age of 48. Also, according to what she wrote on page 147 of her "Taken" book, the military were interested in what she was doing, as one of the abductees she interviewed said to her:

Angie was the next to suffer. After an abduction in early November, she woke up with several physical symptoms, the worst of which was heavy congestion. It quickly grew worse, and in the space of less than two months she had to be hospitalized. Before that time, however, her health had been

remarkably pristine. It was in November, too, that Angie recalls military personnel threatening punishment if she “talked to Karla Turner.”

Turner makes the following remarks on page 153 of the Taken book:

Angie goes further, saying, “Perfectly real aliens exist out there, and it seems one kind wants to help us and another kind wants to deceive us.” Anita has recognized differing agendas among the groups who have interacted with her. She thinks the Grays care very little about humans personally, the humanoids are involved with sexual aspects of the phenomenon (from her conscious recollections, at least), and the Tans are concerned to bind us to them through our emotions.

I think this is more realistic, if we consider

- 1) There are both “good” and “bad” aliens operating here.
- 2) It is possible that humans and aliens are working together, each to further their own interests in maintaining power and control.

Kathleen Marden

Kathleen Marden, who is the niece of Betty Hill has continued to research the abduction phenomenon for most of her life. For example, “Captured,” a book she co-authored with Stanton T. Friedman about the Hill’s 1961 experiences, was published in 2007.³⁸⁴ In October 2012, she published a comparative study based on questionnaires³⁸⁵ answered by those describing abduction experiences and those who had not described such experiences. In the conclusion, she writes (I added the bullet points):

A pattern emerged indicating that the majority of abduction experiencers had conscious recall of at least one event and were with a witness who also recalled the experience.

- *They had a close encounter with an unconventional craft and sometimes observed its occupants.*
- *They are aware of having been examined aboard a craft and were left with perplexing, unexplained marks on their bodies.*
- *Slightly more than half had a nose bleed immediately after an experience.*
- *Women reported an elevated percentage of gynecological problems that appear to be related to reproductive procedures performed by alien entities.*
- *The vast majority was revisited—some more than 10 times—and was taken from their homes to an alien craft.*
- *Often the abduction experiencers sensed an impending visitation by alien entities before it occurred.*
- *The mode of communication between alien entities and humans is almost entirely telepathic.*
- *A new psychic awareness has emerged in the majority of experiencers and about half have found that they now have new healing abilities.*
- *Immediately before or soon after a visitation they become aware of paranormal activity in their homes, such as light orbs, objects flying*

through the air or from walls, doors opening and closing without assistance, etc.

- *The majority noticed malfunctioning electrical equipment, appliances, watches, computers, TVs, radios, cameras, etc.*

Her findings are similar to those of Karla Turner, published almost 20 years earlier. She expanded this study into a book called “Alien Abduction Files: The Most Startling Cases of Human Alien Contact Ever Reported,” which was published in 2013.³⁸⁶

MILABS and Human/Alien Collaboration

Another issue which I have already touched on is whether humans and aliens are collaborating in the area of abductions. One area of research that this typically comes up in is with so-called “MILABS” (or milabs) cases. This term is a contraction of “Military Abductions,” apparently coined by an [Austrian researcher named Dr Helmut Lammer](#)³⁸⁷.

Getting concrete or non-anecdotal corroborating evidence in this area is tricky, it seems. When reading the material, one gets drawn into some murky, disturbing and troubling areas – which often involve some deeply personal, invasive and often terrifying experiences. The only physical evidence associated with these cases seems to be [body marks or injuries](#)³⁸⁸ (which sceptics will always argue have explanations other than those given by the experiencers).

The research conducted by Karla Turner seemed to lay a foundation for later researchers, such as Barbara Bartholic, James Bartley and Eve Lorgren, who I reference below. In reading some of their articles/papers, nearly all the names are pseudonyms and references to specific places (towns, cities) and specific dates and times of events is rare. However, the papers are well written, in a balanced language and the points that they make, I would argue, should be considered carefully, because the overall picture they portray seems to explain certain things about the way geopolitics really works.

Explaining her reasons for researching milabs, [Barbara Bartholic](#)³⁸⁹ wrote:

“What could be more compelling than identifying what I call a ‘master control system’ that defies all locks, law enforcement, physics and governments, and last but not least, human rights; or identifying an alien organized operation possessing such technical supremacy that they can hide in plain sight. It’s a force that can delude people into refusing to believe in their existence.”

Following Bartholic’s footsteps, milabs researcher [James Bartley](#)³⁹⁰ states he is an abductee. He has studied in England and Germany and is a student of Military History with an emphasis on Intelligence-Counterintelligence and Special Operations. James has worked in the Semiconductor Industry, the Telecommunications Industry and in County Government as an Ombudsman. James also worked for the Civil Service at a major military command in an Intelligence related capacity. He is a former business owner. [In an article he wrote dated 23 Oct 2006 called “Milab Operations”](#)³⁹¹ he describes many of

the characteristics of the experiences of other “milabs.” Whilst the material seems unbelievable and outlandish, elements of it, if true, may explain some of the deeply troubling events that have been reported in the news. Also, there are obvious “cross overs” with other uncomfortable areas of research related to disclosed programmes which took place in the 1960s and earlier.

In his “milabs” article, Bartley describes cases of abductees that become part of covert programmes. Most of the examples involve the subjects being involved in some sort of military operation – but they are often used as “psychic spies” or operatives to remote view or even remotely influence a situation. For example, he writes:

A military controller can then guide them through the remote viewing process. One female milab has described feeling as if she is physically at the location where her controllers had sent her.

She found herself in an underground tunnel system quite close to a number of people. From her description of these people they seemed to be the remnants of the Taliban and/or Al-Qaeda in Afghanistan. Her controllers had to reassure her that the people at the target location could not see her. She positioned herself quite close to them and was able to give precise intel to her controllers. The people were subsequently killed with earth-penetrating ordnance delivered by strike aircraft. The female milab witnessed the explosion but did not feel the blast or suffer any ill effects whatsoever. This process was repeated a couple more times with other groups of people that were found within the tunnels.

Bartley’s article mostly describes milabs usage in military, mostly earth-based operations. However, he includes reports of reptilians (some of whom undergo shape-shifting). He also mentions Dracos (from alpha Draconis) and snake entities. He explains that some operations that milabs partake in may be on different planes of reality (i.e. in a non-physical realm). He also mentions that milabs may have “stage managed dreams” and they are manipulated at both an “astral” and physical level. He notes that there is a cross over with MKULTRA and Monarch type mind control programmes in the way that milabs are themselves programmed. They are subjected to physical and mental trauma to “fracture” their personalities, so that new personalities can be “downloaded to them.” He talks about milabs being “paired up” as supposed “soul mates” at an “astral level” but then things are arranged so that they meet physically too. Accounts relate how the milabs may recognise each other when meetings are somehow arranged – for example while taking a bus or train ride somewhere.

Bartley also discusses the idea that the military groups who are running milabs are kind of in a war with groups of reptilian beings:

The picture is further muddled by the fact that certain groups of ETs, space-faring reptilians and Earth-based reptilian groups have an abiding interest in particular milabs and milab family trees. There may be a cosmic tug-of-war going on over certain milabs. This seems to have been the case in a number of instances. The milab controllers are aware that some of the ET groups have installed mind control programs within certain milabs and utilize these milabs as operatives. As we shall see below, there are certain milabs who

are trained and utilized by elements of the military that are allied with certain ET groups.

Many of these themes are repeated in stories told by certain abductees. It is also sometimes stated that greys are subservient to reptilian or human groups. Bartley writes:

It is possible that some of the "aliens" that milabs have seen in above-ground and underground installations were genetically cloned life forms created by and subservient to the military. Milabs have described "greys" that apparently worked for the military in underground installations. Milabs have been onboard a large craft with a joint human-alien crew and the greys there seemed to be under the control of the human military. Milabs have witnessed human military personnel giving orders to the greys in various settings. Greys have even aided the military in kidnapping milabs out of their homes.

Bartley mentions [Cathy O'Brien's case](#) (see "[Tranceformation of America](#)")³⁹² and he states that Mark Philips is probably her handler and he has been used to keep tabs on some of the other stories of other milabs/monarch victims. Bartley mentions David Icke's research too, as well as the infamous [Arizona Wilder](#).³⁹³ This case is laden with disinformation.

[An interesting article dated 29 January 2010, by Eve Lorgren, M.A.](#)³⁹⁴ asks:

My question is, "Did anyone ever consider the superior mind control capabilities of the aliens, so that an overt takeover of humanity is unnecessary?" All they have to do is distract us with other issues such as environmentalism, endless political arguments, constant relationship manipulations, religiosity, or compulsions to blame each other or our military industrial complex's dark agenda as the enemy. Even though these are valid concerns, it doesn't make sense, at least in cases where aliens are observed in collusion with the shadow government abductors. It has been my educated guess (via consults with milabs and independent studies) that the military industrial complex is heavily influenced, if not taken over, by the malevolent alien factions such as the Draco's, reptilians and some greys, as well as the Illuminati bloodline families. Furthermore, there is ample evidence quoted from ancient archaeology and history experts like Michael Cremona, Richard Dolan, Graham Hancock and Michael Tsarion that our ancient star gods were the same reptilians (i.e., Anunnaki) who have corrupted and manipulated Earth's religions for thousands of years. They created the secret societies! Out of the frying pan and into the fire?

So, if we accept that we are being visited by aliens, then what is the purpose of their visits? How long have they been here? Can we entertain that some groups really would like to exploit humans physically and spiritually - and exploit our planet's resources? I was also interested to read the following passage in Eve Lorgren's article:

I've noticed numerous times, whether the milab had MPD/DID or not, that they had a tendency to either preach Christian Fundamentalism or some New Age environmentalist propaganda, instead of getting into any specific detail about their own mind control programming, and how they are healing and processing their experiences. Could the compulsion to preach or get on the New Age environmentalist bandwagon be another program that is inserted as a defense mechanism to avoid the deeper issues of the

powerlessness and reality of trauma and mind control? I'm not saying there is anything wrong with having a Christian faith or being environmentally conscious, it's just the way in which I can see how these belief systems are used as a method of distraction.

I also whole heartedly agree with this statement.

If we can focus on unveiling the secrets of mind control, human or alien instigated, I think we can regain our power back as a race, free from the false god, manipulated religious corruptions, or the shadow government-military-industrial complex.

Lorgren also notes the crossover of reported events and situations experienced by milabs and those reported by victims of satanic ritual abuse. Maybe the following is a worthwhile observation:

A few SRA Illuminati cult victims have told me privately that the secrets of trauma-based mind control, including demonic layering and bloodline control have been going on for thousands of years. This, nor aliens, are new to our post Roswell, UFO crash era.

She relates how similar the emerging themes are to those in shamanic traditions – which also talk about stolen foetuses, demonic possession and energy vampirism. We should pay attention to this. Lorgren interviews a milab called “Lilu” - and she discusses aspects of sexuality and how aspects of sexual energy and relationships can often be a central feature of many experiences (yet another reason why it is difficult to openly discuss such experiences).

“Lilu” states:

Human sexuality is one of the most powerful psychic forces in the universe.

This then, perhaps, is directly related to what Wilhelm Reich was researching in relation to orgone energy and his book “[The Function of the Orgasm](#).”³⁹⁵ If there were a group of ETs who wanted to manipulate us, then it seems likely they would be very interested in this aspect of human nature.

One other story which repeatedly comes up in researching milabs and alien abductees are experiments in mind control and psychic manipulation which allegedly took place as part of the [Montauk Project](#).³⁹⁶ This is yet another “far out” tale which I can’t dismiss as total fantasy or complete disinformation. [Those interested can listen to interviews with Preston Nichols](#)³⁹⁷ [and others](#)³⁹⁸.

One overriding question is - if this stuff is “all in the mind” of an experiencer, why do we see so many common details between these cases? Why would they make up these stories? It is yet another area of research where there are no easy answers of any kind.

In recent decades, it has been revealed how paedophile networks operate at the highest levels of society (see the documentary “[Conspiracy of Silence](#),”³⁹⁹ for example). We have also seen a disturbing set of what are portrayed as “lone gunmen killings” such as those at Columbine, Virginia Tech, Norway and several in the UK. Are these shootings the result of milabs type victims being programmed and made to commit atrocities (often assisted by “black ops” snipers)? There are many commonalities between milabs’ accounts and what are called “Manchurian candidates.” One thing I can say with a high

degree of certainty is that the intent behind the events of 9/11 and the intent behind the shooting events - and the deception associated with the reporting of them – is very similar to the intent behind the treatment that certain alien abductees and milabs victims have been subjected to. It's certainly “alien” to my way of thinking, acting and reacting.

Aliens and Agenda 21

Earlier, we referred to cases of milabs victims talking about environmental peril and destruction. We will explore this area a little more here.

For those not familiar with [Agenda 21](#), they can read the UN's 1992 [document](#)⁴⁰⁰, which I wrote more about in my [“Climate Change and Global Warming: Exposed”](#) book³⁴⁴. As you can probably guess if you're not familiar with it, it's all about protecting the environment and living sustainably. All good stuff, right? Well, that depends on what you know about advanced technology being suppressed and misused (which is one of the themes of this book as well as two of my other books). In [Dr John Mack's 1994 book “Abduction – Human Encounters with Aliens”](#)⁴⁰¹ on page 204, he writes:

Sara suggested that the aliens may be assuming the forms of technology “in order to be more accessible to us,” to appear, for example, in something that looks “kind of like an airplane to make it a little easier.” She, like many of the other abductees with whom I have been working, spoke of the cataclysmic physical changes that may be ahead for the earth and wondered if somehow ecological and environmental concerns could unite humanity and help us transcend ethnic, cultural, and other boundaries.

On pages 392-3, Mack writes:

The information that abductees receive is concerned primarily with the fate of the earth in the wake of human destructiveness. Scenes are shown of the planet wasted by nuclear war and especially of the earth's environment devastated by pollution and toxic clouds. Sara and Arthur, for example, were shown great black clouds or “blobs” suffocating the earth's living systems, the effect presumably of environmental catastrophe. A number of abductees have been shown apocalyptic images of the earth itself literally cracked open or broken up, followed by elaborate triage scenes in which some people will die, others will survive in some way on Earth, and still others will be transported to some other place where human life will continue in a new way.

Although these abductees were telling their story before the events of 9/11, why have the aliens never given them better information? For example, we can be almost certain, [following the events of 9/11, that Weather Modification technology has been in operation since at least 2001](#)⁴⁰² – and it was likely used decades before then. So why didn't the aliens tell anyone “there are covert groups operating on earth – they are modifying the weather without your knowledge. They are keeping technology secret which could mitigate all environmental problems. They are deceiving you.” If I can know this from my own research in the last 15 years, why can't the aliens tell others the truth?

My thrust here is to suggest that the people that are communicating with the abductees are not necessarily off-world aliens. I suggest that they are an earth-based group, connected to the same people that are keeping technology suppressed and destroying enormous buildings (on 9/11) to “ramp up” their programme of global deception and fear generation. Or, if the contactees and abductees really are in contact with aliens, then the aliens themselves are deceiving people. Indeed, this was the conclusion that Karla Turner came to in her own research.

Marshall Vian Summers (Not an Abductee)

Although Marshall Vian Summers is not an abductee, or an abductee researcher, I wanted to mention him, in relation to the “environmentalism” issue I discussed, above.

I made a brief quote from [Marshall Vian Summers](#)⁴⁰³ in my first book “9/11 Finding the Truth”. I first heard of him in about 2007, on a Coast to Coast interview. He has written several books (channelled from an “external source”), which are available for free viewing/download from his “[Allies of Humanity](#)” [website](#)⁴⁰⁴, where he writes:

An Urgent Message

About the extraterrestrial Presence in the World today

We represent a small group who is observing the events of your world. We come from the Greater Community. We do not interfere in human affairs. We have no establishment here. We have been sent for a very specific purpose—to witness the events that are occurring in your world and, given the opportunity to do so, to communicate to you what we see and what we know. For you live on the surface of your world and cannot see the affairs that surround it. Nor can you see clearly the visitation that is occurring in your world at this time or what it portends for your future.

We would like to give testimony to this. We are doing so at the request of the Unseen Ones, for we have been sent for this purpose. The information that we are about to impart to you may seem very challenging and startling. It is perhaps unexpected by many who will hear this message. We understand this difficulty, for we have had to face this within our own cultures.

The message seems to be one of raising one’s own awareness. The ethos behind the writings seems to be similar to that of Gnosticism – in that one should develop an “inner knowing” (or follow “The Way of Knowledge and Insight.”) However, reading through the first book, little specific detail is revealed. The following passage is fairly typical:

Humanity is approaching a very dangerous and very important time in its collective development. You are on the verge of emerging into a Greater Community of intelligent life. You will be encountering other races of beings who are coming to your world seeking to protect their interests and to discover what opportunities may lie ahead. They are not angels or angelic beings. They are not spiritual entities. They are beings who are coming to your world for resources, for alliances and to gain an advantage in an emerging world. They are not evil. They are not holy. In that, they are also

much like you. They are simply driven by their needs, their associations, their beliefs and their collective goals.

A [10-point summary](#)⁴⁰⁵ seems (to me) more accurate as to what is going on. For example, points 6 and 7 read:

6. Because the Intervention is being carried out by small groups of intervening forces, it must rely primarily upon deception and persuasion to achieve its goals. The Allies Briefings describe in detail how this is being accomplished and what we must do to stop it.

7. This extraterrestrial Intervention is being focused in four arenas:

- It is influencing individuals in positions of power and authority to cooperate with the Intervention through the promise of greater wealth, power & technology*
- It is creating hidden establishments in the world from which the Intervention can exert its influence in the Mental Environment, seeking to make people everywhere open and compliant to its will through a “Pacification Program”*
- It is manipulating our religious values and impulses in order to gain human allegiance to their cause*
- It is taking people against their will, and often without their awareness, to support an interbreeding program designed to create a hybrid race and a new leadership who would be bonded to the “visitors.”*

It was this sort of thinking/statement that first got me interested in Summers’ material.

Summers also talks about “The New God Experience” and has a page stating: [“God’s Plan is Beyond Human Understanding.”](#)⁴⁰⁶ It is unclear to me why his teaching should be framed in this model of a “discarnate (probably male) entity” that is “running everything.” I am more interested in learning about the aliens!

But then for me, it all “falls apart” when I hear his son, Reed Vian Summers, stating the mainstream deception about Climate Change and Sea Level Rises without mentioning anything that is already known, for example, about 9/11 and Geoeengineering, which I have written about in my (non-channelled) other book “Climate Change and Global Warming Exposed.” [In a 2017 interview with Iain Lee](#),⁴⁰⁷ at 27:20, the following is said:

Iain Lee: What does the message that Marshall has received...say about climate change and where we’re potentially heading up...?

*Summers: Well gosh it has a lot to say in fact be prepared for... it paints a very sober picture of the future - regardless of whether or not we can take action now to **mitigate future emissions...***

Past emissions have baked into our future certain ramifications and certain eventualities that we will face, you know, and we are going to have to have the wisdom and the compassion to navigate that difficult future.

*It makes some very startling declarations - it says that 30% of the world’s agricultural land will be lost. It says that **the ports and cities of the world may be flooded in 30 years’ time. That there will be an enormous***

amount of sea level rise in a far shorter period of time than we all currently think in what scientific consensus currently states.

*And again this is a prophetic message here to really alert us to **the environmental calamity that we have created through you know misuse and overuse of our world's natural environment** and this is the future we will have to face... and in fact the new message makes clear that there are two great threats to humanity at this time ... and these are the only two that can do it and these two are the environmental crisis we are facing primarily in regards to climate change and sea level rise and second intervention from beyond our world...*

Sadly, it appears that those alien groups who are deceiving people (see point 6 above) might have got to Marshal – and his son.

Dr Rick Strassman and DMT

In 2001, Dr Rick Strassman published a book called “[DMT: The Spirit Molecule](#)”⁴⁰⁸. This important book detailed his efforts to clinically test the effects of a substance naturally produced in the body in limited quantities. In the introduction to this book, Strassman writes:

These studies investigated the effects of N,N dimethyltryptamine, or DMT, an extremely short-acting and powerful psychedelic. During the project's five years, I administered approximately four hundred doses of DMT to sixty human volunteers. This research took place at the University of New Mexico's School of Medicine in Albuquerque, where I was tenured Associate Professor of Psychiatry.

Strassman also describes how DMT is responsible for generating psychedelic experiences in people and it therefore appears to have consciousness-altering effects for those people who are given a certain dosage. As is implied by the description above, the effects of a single dose are relatively short-lived – about 20 minutes. It is a controlled substance and so Strassman went through a lengthy approval process before his clinical research could commence. For this and other reasons, his study has never been repeated.

DMT is the “active ingredient” in [Ayahuasca](#)⁴⁰⁹ – a liquid which is/was made by Shamans in South America and used as part of their “usual” activities. Since the turn of the millennium, “[Ayahuasca Tourism](#)⁴¹⁰” has been on the increase.

It is also true that most cultures have their shamanic traditions. [For example, in Europe, such traditions were based on the use of different substances, such as those found in certain types of mushrooms.](#)⁴¹¹

My reason for mentioning Dr Strassman’s research and DMT is that he found that a number of his subjects, when they had their psychedelic experience, following a dose of DMT being administered, described something quite similar to an alien abduction. For example, in chapter 13 of “[The Spirit Molecule](#),” Strassman gives volunteer Dimitri’s account of his DMT experience.

I felt like I was in an alien laboratory, in a hospital bed like this, but it was over there. A sort of landing bay, or recovery area. There were beings. I was

trying to get a handle on what was going on. I was being carted around. It didn't look alien, but their sense of purpose was. It was a three-dimensional space. I expected cartoonlike creatures, like a commercial for LSD, but this was "Oh my gosh! Oh my gosh!" It was unlike any other DMT experience I've had.

They had a space ready for me. They weren't as surprised as I was. It was incredibly un-psychedelic. I was able to pay attention to detail. There was one main creature, and he seemed to be behind it all, overseeing everything.

The others were orderlies or dis-orderlies. They activated a sexual circuit, and I was flushed with an amazing orgasmic energy. A goofy chart popped up like an X-ray in a cartoon, and a yellow illumination indicated that the corresponding system, or series of systems, were fine. They were checking my instruments, testing things. When I was coming out, I couldn't help but think "aliens."

In chapter 14, Strassman writes:

Let's review the popularly reported "alien abduction" experience. We will see the striking resemblance between these naturally occurring contacts and those reported in our DMT study. This remarkable overlap may ease our acceptance of my proposition that the alien abduction experience is made possible by excessive brain levels of DMT. This may occur spontaneously through any of the previously described conditions that activate pineal DMT formation. It also might take place when DMT levels rise from taking in the drug from the outside, as in our studies.

If we return to the "milabs" subject for a moment, we can wonder what might happen if military abductors inject some form of DMT into their subjects. If covert groups have done their own research, they may have developed a "version" of DMT "more appropriate" to their requirements. If such groups are carrying out their own physical abductions, would they administer doses of DMT to the victims, just to confuse them even more? Or would doing this actually be part of "consciousness altering" procedures used in these operations, for a particular purpose? That is, I am not trying to explain away abduction experiences as all being the result of experiencers having higher levels of DMT in their bodies.

Shamanism and Abductions – A Comparative Study

A year before the publication of Strassman's book, [a research paper by Simon Brian Harvey-Wilson, B.A., compares aspects of Shamanic experiences to those reported by alien abductees.](#)⁴¹² He draws on the research of Dr John Mack, Mary Rodwell, Budd Hopkins, Ann Druffel and a number of others.

His conclusion makes interesting reading:

As stated in Chapter 1, the research question for this study is whether any of the eleven alien abductees have had experiences similar to shamanic experiences, especially initiation experiences, and if so, what were those similarities and what were the differences? During the interviews it became clear that many of them have had, and are continuing to have, numerous experiences similar to shamanic ones. These experiences, as well as the distinctly shamanistic world-view that the abductees appear to develop as a result of their experiences, have been documented and discussed in the four

preceding interview analysis chapters. While discussing any particular shamanistic similarity, the interview analysis makes it clear whether most or just one or two of the abductees have had certain types of experiences. For example, while ten of the abductees claim to be involved in some forms of healing activity - an important shamanic activity - only one of them claims to carry out the less overtly shamanic function of psychopomp (spirit-guide), although many of them believe in some form of life after death.

Conclusions

Due to the very nature of the alien abduction phenomena, it is often quite resistant to conventional methods of investigation. Once the surface is scratched, the investigator quickly gets drawn into a strange world of dreams, psychedelics, horror, fear, abuse, and torture (both mental and physical). Stories of aliens, demons and spiritual warfare are never too far away. Travel through space and time is also a recurring theme. Perhaps we have to accept there are truly different realities we could experience – voluntarily and when under someone else’s power or influence.

15. AFB Landings and Presidential Close Encounters?

For many years, rumours have circulated that President Dwight (Ike) Eisenhower met with a “delegation” of aliens at an Air Force base either in 1954 or 1955 – or both. For many, this is yet another area which seems too crazy to even bother investigating. As ever, we can ask, “what evidence can we find to support the conclusion that such a meeting really happened?”

The Greda Treaty?

The first time I heard this story was, I think, somewhere in the account of [Phil Schneider, who claimed to have worked on the construction of an underground base](#).⁴¹³ I was not convinced by Schneider’s claims and it seems he did not produce much documentation to support such claims. (For example, he wasn’t able to produce any documents about the alleged underground base in Dulce New Mexico – which we will discuss in the next chapter). I therefore considered that the story of the presidential meeting and treaty was also probably not true. Perhaps I was “too hasty.” [An article on Grant Cameron’s Presidential UFO website simply quotes UFO Researcher Bill Moore’s March 1989 article which was published in the “Hollywood Gazette” newspaper](#)⁴¹⁴. Moore describes the rumour that Eisenhower visited Edwards (Muroc) Air Force Base in early 1954, and either viewed the bodies of dead aliens and the wreckage of their craft or met with live aliens on some sort of “diplomatic mission” to earth. Moore notes that Eisenhower did indeed stay in the Palm Springs area (about 100 miles from Edwards AFB) from 17th – 24th Feb 1954 and his movements were (initially) unaccounted for on 20th Feb. It was later claimed that Eisenhower had had emergency dental treatment during the period, but Moore recounts that searches at the Eisenhower Presidential library did not reveal the details normally associated with such an event. (That is to say that the President’s officials normally keep records of such events and even copies of “thank you” letters sent to people who were involved in “incidents” such as this. For example, Eisenhower also attended a church service in the area, as part of the same trip and the library had a copy of a letter of gratitude sent to the minister who ran the service.) Moore also discusses the account of “an elderly mystic” called Gerald Light who, in a letter (dated 16 April 1954) to the head of a Southern California metaphysical organization, claimed to have been at Edwards AFB and seen Eisenhower, saucers and the aliens.

[Dr Michael Salla, in a paper he first published in January 2004, expands on Moore’s analysis considerably](#).⁴¹⁵ Where Moore seems to gently mock Gerald Light, Salla researched Light’s letter, which named people that were also involved in the meeting (an economic adviser, a church leader and an experienced journalist/reporter). Regarding the Gerald Light account, Salla concludes:

It may be concluded, then, that the following items all make up circumstantial evidence that a meeting with extraterrestrials occurred. The first is Eisenhower's missing night. The second is the weak 'cover story' used for Eisenhower's absence. The third is Light's description of actual events at the meeting in terms of the psychological and emotional impact of the described meeting which is consistent with what could be anticipated. The final is Light's description of the composition of community leaders or 'wise men' at the meeting. These four items collectively provide circumstantial evidence that a meeting with extraterrestrials occurred and that Eisenhower was present.

Salla then explores statements made by a US Navy Commander called Charles L. Suggs and John Lear. In 1991, researcher William Hamilton interviewed the son of Charles L. Suggs (who bore the same name as his father). Hamilton reported:

Charlie's father, Navy Commander Charles Suggs accompanied Pres. Ike along with others on Feb. 20th. They met and spoke with 2 white-haired Nordics that had pale blue eyes and colorless lips. The spokesman stood a number of feet away from Ike and would not let him approach any closer. A second Nordic stood on the extended ramp of a bi-convex saucer that stood on tripod landing gear on the landing strip. According to Charlie, there were B-58 Hustlers on the field even though the first one did not fly officially till 1956. These visitors said they came from another solar system. They posed detailed questions about our nuclear testing.

The meeting, then, was related to nuclear testing. The aliens, according to some of the statements made by Lear and Cooper etc wanted to get an agreement to ban or limit nuclear testing that was going on then. However, an agreement was not reached. Salla notes that there are discrepancies between the accounts of the meetings which apparently took place.

Other whistle-blowers who state that a meeting took place include Colonel Corso – who describes how a surrender was negotiated with the ET's (see P292 of the "Day After Roswell" Book). Disclosure Project Witness Don Philips, who was in the USAF and also worked at Lockheed Skunkworks, also alleges that Eisenhower met ET's in 1954.

Bill Cooper and John Lear have made further statements about the meetings and agreements. It seems that more than one group of ET's were involved.

In Salla's paper, John Lear is also quoted thus:

... a deal was struck that in exchange for advanced technology from the aliens we would allow them to abduct a very small number of persons and we would periodically be given a list of those persons abducted. We got something less than the technology we bargained for and found the abductions exceeded by a million-fold than what we had naively agreed to.

Perhaps Lear was just quoting from [chapter 12 of William Cooper's "Behold a Pale Horse" book](#)⁴¹⁶. Although this book is unevenly written and he has a tendency to switch topics too frequently for my liking, what Cooper states seems to be largely in agreement with what I have found via other sources, and some of the material included elsewhere in this book. Here are some quotes from Cooper's book:

“An alien craft was found on February 13, 1948, on a mesa near Aztec, New Mexico. Another craft was located on March 25, 1948, in White Sands Proving Ground. It was 100 feet in diameter. A total of 17 alien bodies were recovered from those two crafts. Of even greater significance was the discovery of a large number of human body parts stored within both of these vehicles.”

“During his first year in office, 1953, at least 10 more crashed discs were recovered along with 26 dead and 4 live aliens... Early in 1953 the new President turned to his friend and fellow member of the Council on Foreign Relations Nelson Rockefeller. Eisenhower and Rockefeller began planning the secret structure of alien-task supervision which was to become a reality within one year. The idea for MJ-12 was thus born... Asking Rockefeller to help with the alien problem was to be the biggest mistake Eisenhower ever made for the future of the United States and maybe for humanity.”

“In 1953, astronomers discovered large objects in space which were tracked moving toward the Earth. It was first believed that they were asteroids. Later evidence proved that the objects could only be spaceships... When the objects reached the Earth they took up a very high geosynchronous orbit around the equator. There were several huge ships and their actual intent was unknown. Project SIGMA and a new project, PLATO, through radio communications using the computer binary language, were able to arrange a landing that resulted in face-to-face contact with alien beings from another planet.”

“In the meantime, a race of humanoid aliens landed at Homestead Air Force Base in Florida and successfully communicated with the U.S. government. This group warned us against the race orbiting the equator and offered to help us with our spiritual development. They demanded that we dismantle and destroy our nuclear weapons as the major condition. They refused to exchange technology citing that we were spiritually unable to handle the technology we already possessed. These overtures were rejected... It may have been an unfortunate decision.”

“President Eisenhower met with the aliens (first group) on February 20, 1954, and a formal treaty between the alien nation and the United States of America was signed... Shortly after this meeting President Eisenhower suffered a heart attack... The treaty stated that the aliens would not interfere in our affairs and we would not interfere in theirs. We would keep their presence on earth a secret. They would furnish us with advanced technology and would help us in our technological development. They could abduct humans on a limited and periodic basis for the purpose of medical examination and monitoring of our development, with the stipulation that the humans would not be harmed, would be returned to their point of abduction, would have no memory of the event, and that the alien nation would furnish Majestic Twelve (MJ-12) with a list of all human contacts and abductees on a regularly scheduled basis... It was agreed that bases would be constructed underground for the use of the alien nation and that two bases would be constructed for the joint use of the alien nation and the United States Government.”

“By 1955 it became obvious that the aliens had deceived Eisenhower and had broken the treaty. Mutilated humans were being found along with mutilated animals across the United States... it was suspected that not all abductees had been returned... The aliens stated that they had been, and were then, manipulating masses of people through secret societies,

witchcraft, magic, the occult, and religion. You must understand that this claim could also be a manipulation. After several Air Force combat air engagements with alien craft it also became apparent that our weapons were no match against them."

We should note here that William Cooper later retracted some of the claims he had made about the UFO/ET related information he had discussed, but I am not sure which claims he retracted. Also in "Behold a Pale Horse," (pages 18 and 19) Cooper recounts a UFO sighting he had while he was in the US Navy – sometime in the 1960s (probably 1966). When he was stationed on the USS Tiru (SS-416) he (and others) witnessed a craft leave the water and fly up into the clouds and then return to the water a short while later.

We can also note that some of the information John Lear reports seems totally fantastic. However, just as importantly, we should note that [William Cooper predicted that "something" would be blamed on Osama Bin Laden, three months before the events of 9/11.](#)⁴¹⁷ Cooper was killed in a shooting incident near his property in November 2001.⁴¹⁸

Similarly, we note that in 2008, John Lear supported Dr Morgan Reynolds in his 9/11 Court Case against NIST's contractors.⁴¹⁹ This leads me to give some additional credibility to Cooper and Lear.

Landings at Holloman AFB

Seemingly corroborating some of what Bill Cooper said, another account relates how Eisenhower went to Holloman AFB on 11 Feb 1955 (landing, funnily enough at 9 a.m....) This story was extensively investigated by [Art Campbell](#),⁴²⁰ a US Navy Veteran and retired School teacher. Campbell gathered at least three significant witness accounts, [described in an article on his website](#)⁴²¹ and [in a presentation he gave at a conference in 2010](#)⁴²². The evidence Campbell collected is also summarised in a [17-minute video someone has edited together](#).⁴²³

Bill Kirkland was working at the Holloman Base Hospital and on the day, he was told that a disk had been seen hovering over or near the base. He wanted to go out and see the disk himself, but Kirkland stated this meant he would have been leaving his post, which was against military law, so he never actually saw the disk himself. However, he knew that Eisenhower was going to come to the base because his commanding officer had discussed Kirkland's possible role in an honorary parade for the President. The plans for such a parade were abandoned just before the visit, however. Kirkland also claimed, on the same day, he heard two pilots talking about a crashed saucer at Roswell and other events, such as a landing at an airbase.

Albert D Wykhoff was the name Art Campbell gave to a cargo loader who was at Holloman AFB in "mid-February," 195. Wykhoff claimed he saw Air Force One come into the base. On the day, they were forbidden from leaving the base, until Eisenhower had left. He apparently listened to a speech Eisenhower gave at the base. However, he didn't see a disk.

Another person with information about the Eisenhower meeting at Holloman was Pat Sorensen, whose father, Bill worked at Holloman AFB in 1955. Pat Sorensen had a 1989 letter from her father in which he described a story that he had told her when she was younger. He was a fireman at Holloman and reported that he, too, had heard of the President's visit. Bill Sorensen had also heard reports of a disk hovering over the base. In the letter, he tells the story of how he climbed up a pole to get a better view across the base and he reported that he saw a metallic disk, about 25-30 feet across – it was coming towards him. He was so startled he quickly descended the pole.

A further set of statements related to the alleged Eisenhower meeting comes from Henry W. McElroy, Jr, retired State Representative to New Hampshire. [In a video statement recorded on May 8, 2010 in Hampton Virginia](#)⁴²⁴, McElroy reports that when serving on New Hampshire's "State Federal Relations and Veterans Affairs committee," he personally saw a document which related to Eisenhower's meeting. He said:

I would like to submit to our nation my personal testimony of one document related to one of these ongoing topics which I saw while in office, serving on the State Federal Relations and Veterans Affairs Committee. The document I saw was an official brief to President Eisenhower.

McElroy continued:

To the best of my memory this brief was pervaded with a sense of hope, and it informed President Eisenhower of the continued presence of extraterrestrial beings here in the United States of America. The brief seemed to indicate that a meeting between the President and some of these visitors could be arranged as appropriate if desired.

McElroy further stated:

The tone of the brief indicated to me that there was no need for concern, since these visitors were in no way, causing any harm, or had any intentions, whatsoever, of causing any disruption then, or in the future.

This document then, did not say that a meeting had taken place, nor did it state that a meeting had been arranged on a particular date. Also, McElroy has not, to my knowledge, given any further details about the document – such as when he witnessed it.

So, the evidence that Eisenhower did have a meeting with ET's in 1954 and/or 1955 is based on second-hand reports. However, if such a meeting did take place, it would make sense that it happened on an airbase – which would be a secure and controlled location - where Eisenhower and his associates might have some type of protection. Also, in such an environment, information about any meeting could be more tightly controlled.

Good Alien, Bad Alien?

As other researchers such as Dr Salla and Grant Cameron have observed, taking into consideration the changes that appeared to happen following the nature of the ET contactee phenomenon between the 1940s and 1950s – in encounters described by the likes of Adamski, Menger and others (which we

looked at in chapter 8), we can compare these to the account, say of Betty and Barney Hill – which was rather different, as they were taken against their will, examined, traumatised and made to forget what happened to them. Was there any relationship between these changes and the alleged meetings between Eisenhower and ET's?

A Landing Filmed at Holloman Air Force Base

Another account of a landing where humans allegedly met aliens has also emerged. In 1973, Robert Emenegger and Alan Sandler, two businessmen from Los Angeles, were invited to Norton Air Force Base in California to discuss the production of several documentary films on advanced Air Force research projects.⁴²⁵ They met with two people - the base's head of the Air Force Office of Special Investigations, and Paul Shartle who was a Security Manager and Chief of requirements for the Audio-Visual Programme at Norton Air Force Base.

At the meeting, Emenegger and Sandler were told about a film, described below, taken at Holloman AFB, New Mexico, in May 1971 – another date given is 20 April 1964. This story was covered in pages (127-129) of a 1974 book that Emenegger wrote, called “UFO's Past, Present & Future.” This book accompanied a documentary with the same title, released at the same time. The Holloman incident was also covered in a very short segment⁴²⁶ of a TV “special event” called [UFO Coverup? LIVE! which aired on 14 October 1988](#)⁴²⁷. In this segment, where Emenegger and Shartle sat together, Emenegger stated:

It was in 1973 when I was Vice President at Grey advertising and I took time out and went to Norton Air Force Base to explore subjects for television specials, related to the Defense Department. While discussing several other subjects, UFOs came up and Paul, here, told us about a film of a landing of alien craft at Holloman Air Force Base, about three years earlier.

Paul Shartle stated:

Shartle: I saw footage of three dish shape crafts. One of the craft landed and two of them went away.

Interviewer: Why did it land?

Shartle: It appeared to be in trouble - because it oscillated all the way down to the ground. However, it did land on three pods. A sliding door opened, a ramp was extended and out came three aliens.

Interviewer: What did they look like?

Shartle: Well they were human-sized. They had odd grey complexion and a pronounced nose. They wore tight-fitting jumpsuits, thin headdresses that appeared to be communication devices. ... In their hands, they held a translator, I was told. A Holloman base commander and other Air Force officers went out to meet them.

Interviewer: You actually saw these aliens on the film?

Shartle: Yes.

Emenegger: This film footage sounded very very special and we wanted to use it as the ending of our television special... Although the Pentagon had been very, very cooperative - all the way - at the last minute the film was confiscated - and we lost the whole finale of our show, but what I saw and heard was enough to convince me that, you know, the phenomenon of UFOs is real - very real.

Interviewer: Mr Shartle, what did your superior officers tell you?

Shartle: I was told it was theatrical footage the Air Force had purchased to make a training film.

Interviewer: Well that sounds plausible doesn't it?

Shartle: Well... if it were a theatrical film, why didn't I have a record of this? It was my job to keep accurate records of all audio-visual purchases.

Interviewer: Is there any other reason that you feel this was not a theatrical film?

Shartle: Yes, it was too real - the people who were shooting that they were Air Force personnel. Lucky for us, the day they were shooting they were doing an acceleration test.

However, what Emenegger said about the film being withdrawn wasn't totally true. It turns out that eight seconds of the Holloman film *was used* in their film. This 1974 film "UFOs: Past, Present, and Future" (re-released in 1976 and 1979 under the title "UFOs: It Has Begun," to coincide with renewed interest in the subject due to the release of Spielberg's "Close Encounters of the Third Kind") shows a dramatic reconstruction of the Holloman landing, using some artistic impressions and a clip of the Holloman film is edited in.⁴²⁸ It is presented as an incident that "might happen in the future, or perhaps could have happened already."

A description of the incident being filmed by three cameras is included, as is the description of the craft landing – in the way Shartle described. It is then stated that the occupants of the craft (two or three aliens) met with a base commander, two officers, two Air Force base scientists – in "an inner office in the King One area" of the base.

Grant Cameron had followed the Holloman AFB film story for years and had spoken to Emenegger quite a few times. In a 2017 or 2018 interview⁴²⁶, Cameron suggests the Holloman film was part of a managed disclosure effort. Cameron states:

They want you to know the Holloman [incident] happened - and they allowed them to use this eight seconds of the film, but the rest of the film – the classified part - was pulled. So they're using these sorts of tricks. So that they're not covering up and they're not disclosing - which means they're doing something in between... They're leaking the story but protecting the classified material.

Cameron states that Emenegger was really not all that interested in the UFO topic and remained rather sceptical – at least in the 1970s, when this documentary was being made. He relates that Emenegger commented that while he was doing research for the documentary, Emenegger came to the

conclusion that “There’s no [UFO]cover-up - I was able to go wherever I wanted.” Cameron continues:

He [Emenegger] went into the Pentagon without signing in. He was able to go and talk to all the Bluebook heads. He was talking to Art Lundahl - who was the big CIA guy for UFOs. He said ... I could ask whatever I want ... and it was true he could ask whatever he wanted. So, he puts his documentary [together] and then what happens at the end of the documentary is, they say “We can’t use the film... We can’t allow... It’s the Watergate [Scandal]. It’s bad timing we can’t allow you to use the film.”

Cameron also notes how Emenegger’s 1974 documentary was funded with \$250,000⁴²⁹ from the MacArthur Foundation⁴³⁰ but in the end MacArthur, after getting some heat, wanted his name removed from the credits, though the funding was still awarded to Emenegger. Cameron then explains how this eventually ends up as “part disclosure” and “part cover up.”

He’d get the money [but] it’s a secret ... and then I find out that there’s eight seconds of the Holloman Air Force Base film in the [documentary] film. So Bob’s my friend – I phone up Bob... “There’s eight seconds of film in there!” And he goes, “Well yeah...” and I said, “You told me they pulled the film. You told me it was sent back to the Pentagon... but there’s eight seconds of film in the documentary...”

Then he said the key words, he said “But it didn’t show anything...It’s background.” I said, “Background? What do you mean it’s background?” He said, “You see the hills of Holloman and you see this object - this brilliantly lit object at six o’clock in the morning coming over the hills - but it’s in the distance, you don’t see it close-up. You don’t see the alien when the alien gets out that’s the classified part.”

In essence, you have a leak, then, which indicates the event happened, but the details are not openly revealed and are left as “stories and rumours.”

Eisenhower got “Sold Out”

Returning to the issue of Eisenhower’s knowledge of the ET/UFO issue, I have always found Brigadier General Steven Lovekin’s disclosure testimony to be most interesting. Lovekin worked under Eisenhower in the White House Army Signalling Agency. In a year 2000 interview with Steven Greer, Lovekin stated⁴³¹:

But what happened was that Eisenhower got sold out. Without him knowing it he lost control of what was going on with the entire UFO situation. In his last address to the nation, I think he was telling us that the Military Industrial Complex would stick you in the back if you were not totally vigilant. And I think that he felt like he had not been vigilant. I think he felt like he trusted too many people. And Eisenhower was a trusting man. He was a good man. And I think that he realized that all of a sudden, this matter is going into the control of corporations that could very well act to the detriment of this country.

Who sold Eisenhower out? Heads of powerful corporations that built the US Military Forces? Were they, for example, Freemasons? (I’m only asking, remember!)

Conclusion

If both the aliens doing the abductions – and the governments that “permitted” it - know that what they are doing is a violation of both cosmic law and human sovereignty, is it any wonder that the UFO/ “Disclosure” scene is riddled with confusion, deception and cover up. Who is going to own up to global, decades-long programmes to suppress world-changing technologies, covertly abuse 1000s of people, take reproductive materials and then wipe their memories...? If it is true that the aliens want to keep their actions secret as well, then how would we “persuade them” to tell the truth when there is no recognised, readily available method of explicitly communicating with them?

Though we don’t seem to have a great deal of strong evidence that meetings have taken place between ETs/aliens and US officials and/or US military personnel, it seems to me that the circumstantial evidence and timeline of events supports the conclusion that something like this happened. Perhaps later chapters in this book will add a little more support to this conclusion.

16. DUMBs, Dulce and Cattle Mutilations

DUMBs and Tunnels

DUMB is an acronym for “Deep Underground Military Base” and some people have implicated these as being involved in both alien abductions and animal mutilations. Can it be true that there really are secret underground bases around the world? That’s an easy one to answer. If you live in the UK, you can visit a formerly secret underground base in Essex – [Kelvedon Hatch](#)⁴³². I visited this fascinating place in January 2018 and was amazed at what was still there. Much of the equipment that was in use in the 1980s and very early 1990s is still “in situ.” The base was meant to allow some government operations to continue in the event of a nuclear strike. The base is on three levels.



Entrance to Kelvedon Hatch – was disguised as large cottage. (Photo: Andrew Johnson – 2018)



One of the doors which was meant to help keep out radiation/fallout following a nuclear attack.
(Photo by Andrew Johnson – 2018)



Equipment in situ (photo by Andrew Johnson – 2018)

The base was sold to its current owner in 1992 following decommissioning.⁴³³

Another base that has attracted some investigators in the UK is [RAF Rudloe Manor in Wiltshire](#)⁴³⁴ (which appears to have ongoing operations – at least in the early 2000s when some investigators/explorers were stopped when they were “nosing around” the place.) In [Australia, there is Pine Gap](#)⁴³⁵ – and other US-run bases. In the US, there are a number of acknowledged and alleged bases and one recommended source of information are [Richard Sauder's books](#)⁴³⁶ and [interviews](#)⁴³⁷. Another alleged underground base is at Dugway Proving Grounds.

Of course, these bases are secure locations, so that is little, reliable information available.

If we consider some of the enormous tunnelling projects that have been completed in the last 20-30 years, we can get an idea of the potential for there to be extensive underground networks in some areas. Northern Europeans regularly travel through the “chunnel” – the [Channel Tunnel which links Folkstone in the UK and Calais in France – a distance of over 30 miles.](#)⁴³⁸ More recently in June 2016, the even longer Gotthard tunnel opened, linking Erstfeld and Bodio in Switzerland – a distance of 57km (35.6 miles). ([It's worth watching the video of the opening ceremony](#)⁴³⁹.) If you start to research the idea of there being a [network of hidden tunnels across the USA, you will rapidly come across this image](#)⁴⁴⁰:



This TBM was allegedly used to make one or more tunnels under the Nevada Test Site (Area 51).

The source of the image above is claimed to be the US Department of Energy (perhaps via Los Alamos National Laboratories – which is almost synonymous with LANL). However, I have not currently been able to trace exactly where or when this image was taken or if it is indeed from work done in a USAF project (the logo could have been photoshopped in for all I know).

We can be assured, however, that underground military bases exist – all around the world. The exact size of some of these bases, and what they contain is, in many cases, classified information. Considering the few simple facts above, and the time period that has elapsed since, say, the end of World

War II, we can surmise there may be some very large, secret underground bases in existence.

Edgar Fouché

When I interviewed whistle-blower Ed Fouché in 2013 and 2014⁴⁴¹, he told me he worked for a time in a facility called DARC (Defence Advanced Research AgenCy) This facility, located to the South East of Groom Airbase, went 10 stories underground. Ed was told that there was a tram (possibly electric) from North of Edwards AFB to the Area 51 Groom Air Base. He also worked down in tunnels which were under the [Jet Propulsion Laboratory, which is connected to Edwards Air Force Base](#)⁴⁴². While he was there, he saw underground entrances 30 feet wide.

Dulce Base?

In the ET/UFO arena, the most famous alleged base is the one in Dulce in New Mexico. Stories about this base have been circulating since the early 1980s and have really become a colourful mythology. The story goes that aliens were either given (or already had) a base in the Dulce area (specifically in the Archuleta Mesa) and it was at least seven levels deep. Abducted humans were taken there and either held captive or underwent medical procedures (as discussed in earlier chapters) and then were returned. The base was, depending on what you read, either a joint human/alien base or completely run – or taken over – by the aliens. Nordics, Greys, Reptilians and Dracos are the names of the various races that come up in versions of these stories.

The main people that have promoted or spoken of these stories are John Lear, Phil Schneider, Thomas Castello and Linda Moulton Howe. Many other researchers, bloggers and so forth have repeated these same stories, which involve the so-called “Dulce Wars,” where humans and aliens shot at each other. The aliens allegedly had some kind of energy weapon. There were casualties on “both sides.” In the mid-1990s, Phil Schneider claimed he was personally involved in this conflict and claimed he was hit with a weapon discharge and injured on his chest. He spent several months giving lectures in the USA about his experiences. [Some of these are available on YouTube.](#)⁴⁴³

We will now briefly explore some aspects of this popular story, considering some of the material that is available about it:

- “The Dulce Book” by “Branton”
- Articles/Papers by Dr Michael Salla
- “Project Beta” – book (2005) by Greg Bishop
- UFO Hunters - History Channel Documentary (2009)
- “UFO Highway” – book (2011) by Anthony Sanchez
- Dulce Base – book (2013) by Greg Valdez

Branton – “Dulce Wars” and the “Dulce Book”

The work of this anonymous author was one of the first that I came across in about 2003 or 2004.⁴⁴⁴ “Branton” appears to have produced two books, using the titles above. The specific information about the alleged Dulce base is spread throughout the work and mixed with many other ideas and stories. It mentions both Phil Schneider and Thomas Castello as being witnesses to some of the terrible events which took place in the base. It is difficult to follow, as the discussion jumps around fairly freely between many different topics. It is hard to judge how much useful information it contains. I had read a lot of this material elsewhere – in works which were better organised.

UFO Hunters – Underground Bases (2009)

In 2009, the History Channel aired a documentary series featuring UFO researchers Kevin Cook, Pat Uskert and Bill Birnes. In this episode, they investigated the Dulce area and spoke to researchers such as John Rhodes, John Lear and several others. They also spoke to Gabe Valdez, who was a State Police Officer in the area. We will learn later that the evidence Mr Valdez gathered - over a period of more than 30 years – provides many answers to what has been going on in this area.

The programme provided some useful information in that residents of the area confirmed that they had regularly seen unexplained lights and UFOs in the area. It is fairly remote – and about 7000 feet above sea level.

Also, of great significance were the ongoing cases of mutilations of cattle in the area. For one rancher called Manuel Gomez, things got so bad, he had to sell his ranch. The cattle mutilations started in 1976 and continued at regular intervals for about 20 years. (We will mention a bit more about cattle mutilations later in this chapter.) Some very strange examples were shown in the Documentary - where, on the owner’s ranch, cattle were found dead - drained of blood and with certain organs removed. Following the death of the animals, in many cases, predators would not approach the carcass and it was even the case that they were not infested with insects, for example.

Some witnesses reported strange lights in the sky at around the same time as the mutilations appeared to have happened. Sightings of military helicopters near the mutilation sites were also reported.

The 2009 documentary took a detour to Missouri, to talk to a man called Galen Jones who, over several years, had lost 26 animals in mutilation incidents, showing that the phenomenon was not isolated to the Dulce Area.

Back in the Dulce area, near one carcass, Gabe Valdez had found gasmasks. From ongoing investigation of many mutilations, Valdez concluded that a key factor of the events was the removal of the cow’s lymph nodes.

But now let us go back a few steps and look at aspects of the Dulce mythology - and how it started. We will then try to explain what was probably going on in the area.

Dr Michael Salla's Articles/Paper

While Dr Michael Salla's articles are thorough, lucidly written and well-organised, as one might expect of a scholar. However, they don't always include strong criticism or deep enough analysis of the topics covered. For example, he tends to accept much witness testimony at "face value." He relies less on physical and documentary evidence and these aren't all cross-referenced with one another enough, in my opinion.

[Salla's 2003 Dulce paper](#)⁴⁴⁵, for example, gives a good overview of how the Dulce story developed. The Dulce story came out in the 1980s – due to the ongoing research conducted by an electronics genius, Paul Bennewitz, who happened to live (literally) across the road from Kirtland Air Force base. Bennewitz had both photographed UFOs over the base and picked up signals which he thought were coming from the Archuleta Mesa area, near the town of Dulce.

[In 2009, Salla \(and others referenced in this chapter\) spoke at a conference held in Dulce itself](#)⁴⁴⁶. Salla's report on this conference gives a good overview of the range of opinion on the case. It also accurately reports what some people who lived in the area have said. This is an important point, because many of the stories that have been circulating about Dulce are not told by the people that actually live in the area.

Salla's report includes a summary of what Greg Bishop spoke about at the event.

Greg Bishop – Project Beta (2005)

[Greg Bishop stated in an interview](#)⁴⁴⁷ that he was contracted to write [a book about the Dulce Base story](#)⁴⁴⁸ – which, as mentioned above, was started when Paul Bennewitz was observing events at Kirtland Air Force Base. [Bishop gave a presentation about the book at a group called UPARS in 2006.](#)⁴⁴⁹

Bishop's book gives an excellent account of the development of the Dulce Story, but it is fair to say that certain things have become clearer about the case since his book was published in 2005.

In Bishop's book, we get some first-hand accounts from Gabe Valdez and others that were directly involved in events *above* ground. For example, in chapter 2, "Dead Cows," we read:

Valdez and three other law enforcement officers had actually cornered one of the furtive lights in a foggy pasture late one night. In an area about the size of a football field, the cops surrounded and then approached a glowing, hovering orange light. As they closed the distance between them, the light abruptly winked out. The moonless night concealed the object as it floated just over their heads with, as Valdez says, "a sound like a small lawnmower motor." This was not the typical behavior accompanied by the whining, whirring, or buzzing sounds usually associated with unidentified furtive flying lights or craft, unless the "aliens" around Dulce used gas-powered engines when shifting into low gear. Other sightings of UFOs in proximity to the

strange animal deaths were not as easy to explain, but many of the crimes had the earmarks of having been engineered by a very Earthly power.

This was just one example of quite a few instances where unusual lights/craft were witnessed – sometimes close up – in that area.

This chapter also relates how a Dr Howard Burgess, a retired scientist who had worked at [Sandia Labs](#)⁴⁵⁰, got involved with the investigation that was started in July 1975. He had suggested illuminating cattle with a set of different Ultraviolet Lamps, while the cattle were corralled on the Manuel Gomez ranch.

As some of the cattle passed an ultraviolet bulb, bluish-purple patches glittered on their backs and sides. “Those cattle were all from one breed and were all between one and three years old,” remembers Valdez. The profile matched those of cattle who had been found dead on the Gomez ranch.

Gomez immediately sold as many head of the “marked” group as he could. When analyzed, the glowing substance was found to contain high levels of potassium and magnesium and was water-soluble. Something was silently flying over the herds at night, shining a UV beam (aka “black light,” appropriately enough) and looking for the cows with the splotches on their backs to drag off and kill before dropping them back to the ground where it was certain that they would be found.

The cattle mutilations continued and people in the area wrote to Senator Harrison Schmitt’s (former Apollo astronot/actornaut), which eventually resulted in a mutilation conference being held in the Albuquerque Public Library on April 20, 1979. (This meeting, incidentally, is referenced in [Tony Dodd’s “Alien Investigator” book](#)³.) It was here that Gabe Valdez (to whom I would give most of the credit for solving the Dulce base mystery) first met Paul Bennewitz, who was causing all the “problems” for the Air Force.

Bishop’s “Project Beta” book is important in showing how the story developed and what Bennewitz had actually stumbled on – which was a top-secret programme called “Starfire.” [Project Starfire](#)⁴⁵¹ developed and employed a method for photographing Satellites from the ground, using what was, at the time, a new technique called “[adaptive optics](#)⁴⁵²” (and this has since been commonly used in astronomical research.) It involves shining a laser, attached to a telescope, up into the atmosphere. This is used in measuring atmospheric turbulence, which can then be cancelled out with adaptive optics, as a way of getting a much clearer optical image of satellites and distant objects. Bishop explains in his book that once the Air Force could identify the satellites, they were able to fire pulses at Russian spy satellites to make them turn away from the earth so that they could not spy on the American Bases etc.

Bennewitz was picking up the signals used in Project Starfire and associating them with the UFO activity he was seeing. After observing phenomena for several months, on 10 November 1980, Bennewitz drove onto the grounds of Kirtland with the photos and films he had. The Air Force took Bennewitz seriously but realised he had actually detected elements of top secret programmes they were running. As Greg Valdez observes in his own book

(discussed later), it appears the Air Force made a mistake. They decided to “handle” Bennewitz by appearing to take him seriously, but they fed him significant amounts of disinformation (as we will cover later). Bennewitz continued to gather information and kept talking to the Air Force and had no idea they were feeding him disinformation – he trusted them. Bennewitz completed a report, which he called “Project Beta”, by the end of 1981 and he sent this to Harrison Schmitt and others. He even wrote to President Ronald Regan. Perhaps if the Air Force had just told Bennewitz that he had discovered something secret, he would have kept quiet – as, by all accounts, Bennewitz was patriotic and definitely understood the need to keep secrets (as he was already supplying products for the military anyway, through his company, Thunder Scientific.)

A big concern was that Bennewitz had been observing “goings-on” at the Manzano Complex - then the largest underground repository of nuclear weapons components in the Western world. Bishop reports in Chapter 12 of “Project Beta”:

Meanwhile, back at the base, the AFOSI had its own problems. Out on a routine patrol near the Manzano complex just after midnight on August 9, 1980, three guards saw a bright light descend to the ground in Coyote Canyon in an area that is not visible to anyone outside the complex. The guards contacted Sandia Labs’ security control, which sent one of their patrols out to the site. As one of the guards approached a security-alarmed nuclear storage bunker, he noticed a very bright light hovering motionless near the ground behind a building that was part of the facility. Taking a shotgun, the guard got out of his vehicle and walked toward the light source. He thought he was looking at a landed helicopter, and tried to radio back for help and advice, but found that his walkie-talkie had stopped working. He crept closer to confront the intruder and realized that the light was actually a round, disc-shaped object hovering motionless just a few feet off the ground. Just as he was about to shout out a warning, the object shot straight up and was lost to view in seconds.

Were these lights extraterrestrial probes or craft? Or were they some type of advanced drone developed by the NSA?

Whatever the answer, the fact that Bennewitz was photographing and documenting their appearance was still of concern to the Air Force.

Bishop’s book contains a complete copy of Bennewitz’s Project Beta report, which contained both good and bad information. Many of the ideas it contained seemed to be seeded by Myrna Hansen, starting in 1980 when she was introduced to Bennewitz as an alien abductee, who had witnessed events related to cattle mutilations, in an alleged underground Base in the Dulce area. Hansen was hypnotised and regressed initially by Leo Sprinkle and it was in these sessions that parts of the Dulce Mythology began to develop. Also described in Bishop’s book is that Bennewitz was given a computer, by the Air Force, to help him decode “alien transmissions” – which, it appears, were actually being sent to him by the Air Force (these communications were deliberately garbled – Bishop’s book reproduces portions of some of these messages).

If we read point 6 from Bennewitz's "Project Beta" report, as shown in Bishop's book, we can see what kind of effect this had on Bennewitz. (I have converted the text to lower case to aid readability.)

6) Cattle mutilations are the other side of the coin and will not be delved into here though they are part of the overall. It appears that the Humanoids are fed by a formula made from human or cattle material or both and they are made from the same material by gene splicing and use of Female encounter victim's ovum. The resultant 204 Embryos are referred to by the alien as an organ. Time of gestation to full use as a utility, ready to work, appears to be about one year. A year in alien time - I do not know.

Further, in a section headed "Weaponry and inherent weaknesses," we read:

Weaponry is one of the keys and in the aliens' present state we can prepare an effective offense. One tends at the outset (I did) to look at their machines and say—that there is no defense or offense. One is overwhelmed by their speed, apparent capability of invisibility and "cloaking", and other covert capabilities not discussed at this time. In particular - the beam weapons are themselves a direct threat and obviously one that must be seriously considered but not overly so.

The Bennewitz report also discusses some aspects of the ship's power and propulsion systems, and aspects of alien behaviour/decision making and communication. Bennewitz became convinced that an alien invasion was afoot and he then discusses development and use of a weapon to attack the alien craft and base.

Of particular interest to me, with this case, is what is not stated is that [Kirtland AFB was \(at least from 2007 to the 2018 date of writing this\) the home of the Directed Energy Directorate.](#)⁴⁵³ This came up when I was involved in researching into the destruction of the World Trade Centre on 9/11 (see "[9/11 Finding the Truth](#)"⁴⁵⁴.)

Also, in Bishop's book, he was somewhat sceptical of the existence of a base in the Dulce area however, according to Dr Michael Salla's 2009 conference report, referenced above, Bishop became less sceptical about such a base because a number of insiders had confided to him that an underground base does exist there.

Also, I was pleased to read that Bishop included the following paragraph near the end of his book:

We could, on the other hand, give Bennewitz the benefit of the doubt. Perhaps there really is an alien presence, and some world governments know exactly what is going on. Perhaps there are secret agreements between alien visitors and those they perceive as the leaders of the human race. If this is true, the last thing that those in the loop would want to do is admit this publicly. It is the trump card in their hand, as well as proof that there is something greater out there. For them, it is the possibility of salvation and ruin at the same time.

We will learn more about the true story of the Dulce Base soon!

Anthony Sanchez – UFO Highway (2011)

More recently, author and researcher Anthony Sanchez included material about the Dulce base in his 2011 “UFO Highway” book⁴⁵⁵. He said that it wasn’t originally his intention to write a book about the Dulce story, but that became one of the main parts of his book and the one which many people seemed most interested in. In a Red Ice Radio interview dated 12 Dec 2011⁴⁵⁶, Sanchez stated he interviewed a suitably mysterious figure called “Colonel X” in 2010. Sanchez was introduced to the Colonel by a former workmate (Sanchez was working as a software engineer for a semiconductor company). Sanchez also visited the Dulce area on quite a few occasions.

Some of “Colonel X’s” information, however, echoes the stories told by John Lear and Thomas Castello. For example, in a later presentation at UPARs on 18 Apr 2017⁴⁵⁷, Sanchez reported the Colonel told him there are “no reptilians” at the base but ET’s were still involved. Sanchez also stated in the Red Ice interview that Dulce is connected to Los Alamos National Labs (LANL) via a tunnel and the base is also funded through LANL.

Sanchez also spoke of “micro nuclear reactor technology” – which was, at one time, being sold as a “transportable power source” by a company called Hyperion. Sanchez incorrectly claims this company appeared after his book came out. However, I found a reference to this same company from 2008.⁴⁵⁸ Sanchez claimed that this micro nuclear reactor technology was used at the Dulce Base (according to what the Colonel told him.) Sanchez also stated in the Red Ice interview that Colonel X showed him one or more photos of an (alien) grey’s directed energy weapon – and a special security access panel.

Sanchez also talks about aliens at Dulce and a “progenitor race” – members of which, he said, would “return” in 2012. If this happened, we didn’t get to hear about it though...!

One interesting point that Sanchez raised is that both Paul Bennewitz and a Police chief at Dulce – reported seeing a very similar teardrop-shaped UFO at times 30 years apart.

Dulce Base – Greg Valdez (2013)

Those wishing to obtain the most likely explanation for many (but not all) of the events relating to the Dulce Base should definitely read Greg Valdez’s “Dulce Base” book⁴⁵⁹. Greg Valdez is Gabe Valdez’s son. Greg, when he was a child, accompanied his father on many journeys around the Dulce area and he witnessed a fair number of the cattle mutilations himself. He was also party to his father’s ongoing investigations.

I mentioned earlier how in one instance of a mutilated animal, a gas mask was found next to it – and this isn’t the only example of evidence which suggested that the cows weren’t mutilated by aliens. As Greg Valdez notes in chapter 2 of his book⁴⁶⁰:

Los Alamos labs provided a lab report from one of the Gomez mutilations to Gabe that indicated the animal had an unidentified strain of Clostridium in

the heart chamber, leading many skeptics to claim the mutilations were simply explained as blackleg. Some investigators, like Kenneth Rommel, later suggested that blackleg was the cause of the mutilations. Ranchers in the area routinely vaccinated for blackleg and were familiar with evidence of blackleg in deceased cattle, and blackleg doesn't leave evidence that an aircraft landed or cause the animal to have broken bones after being dropped from an aircraft. What is important to remember is that anthrax is structurally similar to blackleg, and blackleg is an environmental disease that animals obtain from eating contaminated grass that is transferred through the soil.

So, the implication is here, perhaps, that there were experiments going on with something like anthrax being introduced into the cattle or the environment. As mentioned earlier, what was commonly removed from the cattle were lymph nodes.

Another important finding, which was also reported in coverage of a [similar mutilation incident in a segment of the “UFOs – Past Present and Future”](#)⁴⁶¹ documentary (by a brave vet who was willing to describe what he saw):

When investigators skinned the neck portion of the animals, they would find two large needle marks on the jugular vein of the animal. This was used as a siphon system so the animals' hearts would pump out their own blood.

Other oddities were also noted:

When they found the carcasses of the animals, they also noticed that the decomposition rate was different than in naturally occurring deaths. Scavengers and predators would not feed on these animals. On one of the Colorado cows tested, scientists found large amounts of Vitamin B12, and they found an ion-exchange resin on one of the cows mutilated in Logan County. Liver samples from one of the Gomez mutilations showed a very high level of potassium in the animal's liver. (Potassium iodine is used to block radioactive iodine from entering the thyroid.)

Greg Valdez notes that underground nuclear explosions, which were set up to help extract gas from the ground (a 1960s method of fracking) were not successful and introduced contamination into the environment. This was being tested by the EPA both on herds the government had purchased and “other herds” (most likely some of the afore-mentioned Gomez herd). Due to the times involved, they did test animals of a certain age, because of how the radioactive material accumulates over time and, of course, based on when the explosive test was done and when the animal was born.

Valdez also notes that in the (probably false) information given to Bennewitz, Zeta Reticuli was stated to be the alien's home star – (Greg Valdez thought this was the first time this star had been used – not being familiar with the conclusion drawn by [Marjorie Fish in 1974, following her study of Betty Hill's star map](#)²⁹⁹, which we discussed in chapter 10.) It is certainly interesting to see this mentioned in the Bennewitz story!

The other evidence which is laid out in Valdez's book is to do with secret, advanced aircraft (separate to any advanced drone technology, perhaps) that seemed to have been operating in the Dulce area. Paul Bennewitz was told (by the Air Force) about the crash of an “atomic aircraft.” As Bennewitz had his

own plane, he had actually flown up and photographed the site of this crash – it was a real event. This, Bennewitz initially stated to Gabe Valdez, happened on the Archuleta Mesa, but he immediately corrected himself when it was determined this would have been seen by locals. It illustrated there was confusion between Mount Archuleta and the Archuleta Mesa, which are about 5 miles apart, by line of site.

Gabe Valdez and a party of 3 others went to investigate the crash site (on Mount Archuleta). It was very difficult to reach, due to there being no track or road. They had to cut down trees with a chainsaw to get to the site of the crash, but they found it just where Bennewitz said it was. They found damaged trees, which could only have been the result of something crashing into them. However, there was no radiation at the site, so if the aircraft had had a nuclear or atomic power source, none of the radiation had escaped into the environment.

During one of the trips to the remote sites, they did again see unusual objects. Also, more importantly, Greg Valdez shows a photograph in his book, which was taken on the trip and he states that they determined this must have shown an aircraft that was “optically stealthy” to the naked eye but could be seen on a still photograph under certain conditions. Greg Valdez also reports that, on the trip to the crash site, they were accompanied by someone called Bill who had recently arrived in the area. Valdez writes:

When Bill arrived in Dulce, he stated that he worked for Los Alamos National Labs, which was later verified to be true. He also claimed that he worked at Area 51 on the electronic systems of the stealth aircraft, which according to his resume is also true. What Bill never mentioned, according to his resume, were his NSA and CIA security clearances. He never mentioned some of the projects he was involved with, which are still classified according to his resume. (You can view his resume at the end of this book.) Keep in mind that in 1988, the stealth aircraft was still relatively secret. Its existence was known, but there wasn't a ton of information available about it like there is today.

Overall, Valdez illustrates with compelling evidence, that Paul Bennewitz stumbled upon at least two top secret programmes. Due to the way that things unfolded, Bennewitz actually was shown parts of the classified aircraft technology and a real crash site but given the story that this was to do with aliens and alien spacecraft. Bennewitz had started to tell other people about what he had found, so was perceived as a threat to the secrecy of these programmes (and National Security). Those that communicated with Bennewitz were also monitored. Hence, AFOSI agent Richard Doty and others were assigned to Bennewitz's case and fed all the “alien” disinformation to Bennewitz to make his story seem crazy, so that only UFO buffs would pay attention to it, but they would never be able to prove anything of note.

In chapter 13 of his book, Valdez includes additional thoughts and information about how the stories of the Dulce Alien base were created and circulated. He notes that “the false stories of Thomas Castello and Phil

Schneider have one common denominator: John Lear.” He also notes that, according to [Chris Lambright’s](#)⁴⁶² [research](#)⁴⁶³, Lear and Doty were at the same location in Laos during the Vietnam war. He suggests that Doty and Lear worked together on “the Dulce Papers.” Valdez notes that the story of the abductee (Myrna Hanson) ties in with the Dulce Papers, and the Castello Story is similar to the Schneider story and talks about underground levels and a war between aliens and the government. This story was first talked about by Paul Bennewitz and then passed around between him, John Lear and Richard Doty. But in reality, the story was started by the Air Force and given to Paul Bennewitz by Doty.

Another point raised is that Bennewitz and Lear had a “falling out” around the time the Dulce Papers were released and it’s “one of the very few things you cannot get Lear to talk about.”

So, the end result at the time was that Bennewitz began to think that there was an alien invasion afoot (but this was all due to the way he was manipulated, without his knowledge, by the Air Force). Bennewitz was highly intelligent and much more persistent and thorough in his research than the Air Force anticipated. However, they managed to convince Bennewitz it was all the result of alien activity and so this made it easier for the truth to be covered up, in this case.

It appears that Bennewitz had “found” a secret satellite tracking programme (though he didn’t know this at the time - this is perhaps explained a bit more clearly in Greg Bishop’s “Project Beta” book). Bennewitz also, unbeknown to him – due to the disinformation he was fed - found an optically stealthy aircraft programme, which used some type of laser/light-based propulsion system. Greg Valdez includes more details [about the classified aircraft technology](#)⁴⁶⁴ in his book.

Valdez illustrates, based on evidence collected by his father over many years, that an advanced type of aircraft was being used to visit cattle and remove and return the carcasses. This clandestine work was part of at least 2 other programmes – related to checking for radiation contamination in animal tissue in the area. As implied earlier, Valdez also hints that secret biowarfare research was being done – and the cattle mutilations were probably somehow related to these experiments (which involved the use of some form of anthrax).

He rightly observes that Dulce is not that far away from Nevada - where nuclear tests had been carried out for decades. Less well known is that “nuclear explosive fracking” had been carried out in the Dulce area, in the 1960s, as part of the “Atoms for Peace” programme. This was done at a site called Gasbuggy. Dulce is less than 100 miles from Los Alamos – where the bulk of the Project Manhattan work was completed in the 1940s.

The Real Dulce Base

In chapter 6 of his book, Greg Valdez implies (but does not openly state) that there *is* an underground base in the Archuleta Mountain and it is probably an

“offsite laboratory” for Los Alamos. He implies that an aircraft could fly into this base – and it appears that this is what some people had witnessed. He notes that Edmund Gomez discovered a ventilation shaft in one location on Mount Archuleta. He also found what appeared to be guard towers and there was a road, on the opposite side of the mountain, near where a lot of the activity was observed. A nearby place called the “Redding Ranch” is also involved – where strange lookout towers (said to be hunting towers) are sited. Gabe Valdez also investigated this place and discovered important evidence about the ownership of the Redding Ranch.

Once the evidence supplied by Greg Valdez is studied, it seems fairly clear, in this case, that any involvement of aliens in events at Dulce is minimal or non-existent. He does not rule out their involvement completely (even though some of the people who have left reviews of his book think he does) but points out the evidence only leads back to the CIA and the military and their black programmes.

The story is actually quite similar to the one which [Barry King has told about an alleged underground base in Peasemore, UK](#).⁴⁶⁵ (That is to say that perhaps there is indeed a secret, underground base there, but it has little or nothing to do with aliens.)

More on Cattle Mutilations

As we have briefly covered the phenomenon of animal (mainly livestock) mutilations, I wanted to point out that such mutilations have been going on around the world since the early 1970s. Instances of mutilations of sheep, horses, goats and even cats and dogs have been recorded. As mentioned in chapter 8 of the Valdez “Dulce Base” book, another area that has seen similar grisly events is near the “Skinwalker Ranch” in Utah, USA. ([This place was bought by Robert Bigelow in 1996](#)⁴⁶⁶.) Also in Utah, about 215 miles away from the ranch is Dugway Proving Grounds – [a military base/area that is at least partly concerned with biological and chemical warfare](#).⁴⁶⁷ [Some investigators think there is an underground base there too](#)⁴⁶⁸, but we see a similar situation to that which we have already discussed in the preceding sections, about the Dulce Base.

[Even more troubling cases of the mutilation of humans has been recorded in several instances](#).⁴⁶⁹ Extensive research has been conducted in the [UK by David Cayton](#)⁴⁷⁰, [Mike Freebury](#)⁴⁷¹ and [Phil Hoyle](#)⁴⁷².

[Richard D Hall’s 2009 documentary “Silent Killers”](#)⁴⁷³ documents in detail disturbing and compelling evidence of this phenomenon, covering several cases which have occurred in the UK. In total, the incidents involve thousands of dead animals – and no official body anywhere in the world has properly addressed or acknowledged the clear and present evidence of a secret agency/group that has slaughtered them. It is not acknowledged because doing so would mean it would have to be admitted that there are very powerful clandestine groups operating above the law and beyond the realm of any normal ability to investigate serious crimes.

Dr Steven Greer – Does He Mean Dulce?

In chapter 14 of his 2006 book, “Hidden Truth, Forbidden Knowledge”⁴⁷⁴ Greer again makes a reference which suggests he thinks all abductions are run by the military, as mentioned in chapter 13.

This shadowy cabal forces into the civilian population completely concocted pseudo-extraterrestrial events. Very advanced technologies are used so that covert programs can simulate an extraterrestrial event, an abduction, or a cattle mutilation that looks like ‘aliens’ are invading. In reality, the operation is being run out of a facility in New Mexico or Utah, using unmarked helicopters and specially trained people who swoop in and stage these hoaxed events.

It seems likely that in his reference to “New Mexico” he means “Dulce,” and his reference to “Utah” he means “Dugway Proving Grounds” base, mentioned above. However, I think we can say that it’s something more than conventional “helicopters” that are involved in the mutilation events.

Conclusions

Secret underground military bases exist. We are prevented from knowing what goes on in them. The size of the bases is not well-known but some evidence discussed in this chapter suggests some of these bases are large – large enough to fly an aircraft into. It seems logical that any projects involving aliens would be well-suited to being run underground, but the circulation of disinformation – as with the Paul Bennewitz/Dulce case is usually sufficient to keep things secret to the required degree, for the required length of time.

17. Ancient Aliens (and Ancient Civilisations)

The title of this chapter is carefully chosen, because when one considers ancient history, we can find evidence of ancient, advanced civilisations. Did these civilisations develop on earth, or were they started by “off-worlders,” as some researchers have suggested? It becomes quickly apparent when studying sites such as the [Great Pyramids at Giza, near Cairo](#)⁴⁷⁵ in Egypt and [the temples at Machu Picchu in Peru](#)⁴⁷⁶, they needed some rather more sophisticated construction techniques than dragging roughly cut stones using ropes, levers and wooden rollers to put them in place. Does this mean that we can say aliens had a hand in their design, or construction or both? That question has been written about in thousands of books – and the best I can do here is to mention some of the authors that have written about this area, and mention a few (to me) compelling examples that show at the very least, certain advanced technologies and techniques must have been in use thousands of years ago. However, without more evidence, we cannot definitely say these technologies belonged to aliens. [Yes, we do seem to have some petroglyphs resembling greys and other types of aliens](#)⁴⁷⁷, but did these beings physically land and/or live on the earth? Or are they beings encountered in transcendental experiences?

With regard to aliens, or off-worlders, being involved in our ancient history, I will briefly consider the work of three authors and researchers – Erich von Däniken (“Chariots of the Gods”), Robert Temple (“The Sirius Mystery”) and Zechariah Sitchin (“Twelfth Planet”). It is perhaps von Däniken and Sitchin that are the most well-known but interested readers can also seek out the work of Michael Tsarion, Michael Tellinger and Philip Coppens. [For example, Michael Tsarion, in his book “Atlantis, Alien Visitation and Genetic Manipulation](#)⁴⁷⁹,” talks about an “etheric barrier” being established around our planet.

There have been [several series of “Ancient Aliens” on the History Channel](#)⁴⁸⁰ which, whilst rather sensationalist, have shown some evidence of historical and archaeological anomalies to a wider audience. Of course, this has meant that other websites and videos have been made, “proudly” entitled [“Ancient Aliens Debunked.”](#)⁴⁸¹ On both sides of the issue, evidence is often presented selectively, to ensure that the parties presenting that evidence don’t have to substantially change their worldview. In the debate and discussion of “ancient aliens” particularly, popular religions are referenced and argued over – and because most people value their beliefs more than their knowledge, establishing and accurately discussing certain truths becomes more difficult. People perhaps become too subjective rather than being objective about the evidence.

Religious Belief

With relevance to the “religious belief” issue I will, for the record, state that I am a “lapsed Roman Catholic” and now consider that Christianity, whilst in

general providing something of a moral code for living with other people peacefully, is largely based on an untrue story which was derived from various sources and it was created and it was, ultimately, promoted as a way of controlling and corraling people into certain ways of thinking and behaving. I urge readers to study the [works of people like the late D.M. Murdoch](#)⁴⁸² and [John Lash](#)⁴⁸³ to learn more. If you feel offended by this statement, might I suggest you analyse your own feelings more deeply and ask yourself that if you're willing to consider that what you have been told about UFOs and aliens etc is untrue, why aren't you willing to consider that what you've been told about Jesus and Christianity (or anything similar) might also be untrue?

Ancient Astronomy

There are now a fair number of other authors that have written volumes about Ancient Astronomy or [Archeoastronomy](#)⁴⁸⁴ and it is hard to dispute some of the evidence which shows that early civilisations did have a much more advanced knowledge of astronomy that they are credited for. For example, in the 1970s, Drs. JJ and Desiré Hurtak ([who are well known for their book "The Keys of Enoch"](#)⁴⁸⁵) pointed out how closely the [positioning of the Great Pyramids at Giza match the arrangement of the 3 stars of Orion's Belt](#).⁴⁸⁶ This was then picked up by Graham Hancock, Robert Beauval, John Anthony West and others. As we will see later in this chapter, there is also strong evidence that an African tribe called the Dogon have/had detailed knowledge about the Sirius Star System.



“Red Shift” (software) Generated Graphic

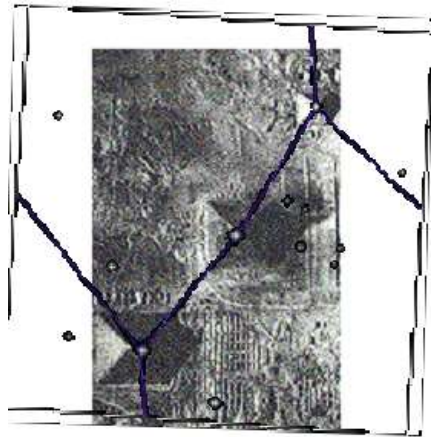

Graphic overlaid on aerial photo of Pyramids

The pyramids at Giza have been constructed in a precise and deliberate way, and their positions on the ground appear to show a relationship to stars in the constellation of Orion. Some argue that there is also a relationship between the stars' brightness's and the size of the corresponding pyramid. (The *larger* the Magnitude, the *less bright* the Star is. However, all three stars are of variable brightness.) [Some claim a similar correspondence can be seen in other pyramids.](#)⁴⁸⁷ [Of course, others dispute this correspondence or say it's not as accurate as is claimed.](#)⁴⁸⁸ Additionally, other facts and statistics about the Giza

pyramids show an encoding of ratios – such as the ratio of the radius of the earth to the radius of the moon. The way the pyramids are aligned (north/south) also suggests the builders knew a great deal about the earth, long before any civilisation was said to have such knowledge.

Gobeklitepe and Bosnian Pyramids

[Gobeklitepe is in Turkey](#)⁴⁸⁹ and it was only discovered in 1994. It appears to be about 12000 years old. I mention the site here because the structures that were excavated there appear to be more evidence of ancient, advanced civilisations that were capable of building something relatively sophisticated. It is now considered to be the oldest temple in the world.

The [Bosnian Pyramids site](#)⁴⁹⁰ has also come to light since the turn of the millennium and could also be archaeologically very significant and perhaps the result of the work of a similarly advanced civilisation, despite claims that there is nothing of significance here. With wider access to online data sources like Google Earth and Google Maps, it has made certain aspects of studying archaeological sites from the air much easier!

Erich von Däniken and “Chariots of the Gods”

I wanted to mention “Chariots of the Gods” as a “lead-in” for this section because it is probably fair to consider Erich von Däniken (EVD) - a Swiss-German Hotelier and one-time manager of a hotel in Davos, Switzerland - as the “Godfather” of the field of research into “Ancient Astronauts” or Ancient Aliens, following his authoring and “birthing” of “[Chariots of the Gods](#)”⁴⁹¹ in 1968 (and it’s still in print over 50 years later). It was in 1964 that EVD first had an article published asking if “the gods of the bible” were astronauts. What became “Chariots of the Gods” was first published (in German) in Switzerland, under the title of “Memories of the Future.” Even if one just looks at the three dozen or so photos in the book, including some petroglyphs of apparent spacemen and photos of some of the accurately [laid blocks at the Sacsayhuaman fortress-temple complex in Cuzco, Peru](#),⁴⁹² it’s easy to understand why EVD’s book became so popular. (Of course, as others have observed, its popularity was probably also due to it being published in the middle of the “space race” of the 1960s.)

EVD, of course, was subject to fierce criticism and ridicule, but it is true to say that he made many important observations and wrote about themes and evidence which the general public have a keen interest, enthusiasm and voracious appetite for. [The biography given on his website, however, is more about the popularity and volume of his work, rather than giving a background about the man himself.](#)⁴⁹³ Nevertheless, it is heartening and enjoyable to listen to a [30-minute interview with him](#)⁴⁹⁴ (even if it is being used as a promo video for Gaia.com) from 2018. EVD is still bursting with enthusiasm for the subject and I, for one, admire his attitude and some of his achievements, though some would of course focus on the idea that he’s “in it for the money.” (Most authors in the field of alternative knowledge – including me –

have had this type of accusation levelled at them, even when they give their work away for free – as I have!)

In the 2018 interview, EVD explains that when he was in school, he had many questions about the Bible – and wondered why, for example, if God was infallible, why he “made a mistake” in creating humans and had to “destroy them” in a flood (a fair question!) He then also wondered why, if “God was everywhere” he needed a “vehicle to travel around” – as is [described in the book of Ezekiel \(studied in depth by Josef F Blumrich\)](#).⁴⁹⁵ In the interview, EVD states that he read the “[Book of Enoch](#)”⁴⁹⁶ when he was 17, which he noted was written in the first person rather than the third person. (The book of Enoch is a scripture that “didn’t make it” into the canon of the Bible, for various reasons. It’s worth a read, as it does have some interesting statements in it, considering it was written down more than 2000 years ago.)

EVD is probably, at least in part, responsible for stimulating the interest of later authors such as Graham Hancock, Andrew Collins and Michael Tellinger.

I am fairly well aware that there are quite a number of mistakes in the original “Chariots of the Gods” book and EVD was repeatedly taken to task over these. Additionally, the style of writing is rather sensationalist and a fair number of assumptions are made. This gives sceptics just what they need for their own “religious cult.” [For example, a sceptical criticism from 1976 by John T. Omohundro \(Skeptical Inquirer Volume 1.1\)](#)⁴⁹⁷ expends 800 words before actually pointing out any errors in the work. For example, Omohundro writes:

Were it not for the fact that Erich von Däniken has millions of otherwise intelligent people discussing his book and theories seriously, I would prefer to write a parody of his style. But I fear his readership might believe me too.

It would be far more appropriate for sceptics like Omohundro to simply point out errors in the work and then talk about what he would like to do with the content.

In 2016, I was witness to something of a peculiar “revival” of the EVD “Chariots of the Gods” phenomenon when I was invited to an [event in the London Princess Anne Theatre \(associated with BAFTA\), called](#)⁴⁹⁸ the “[Erich Von Daniken Legacy Night](#)”⁴⁹⁹ where Erich gave a good presentation about some of his research, including [the interesting discovery of a sarcophagus in a pool under the great pyramid of Giza](#)⁵⁰⁰. Then, men in suits (presumably those that had stumped up the cash to pay for this glitzy event) spoke of a new “[Chariots of the Gods Franchise](#)”⁵⁰¹ which was already set to produce a Hollywood Movie and maybe even build a theme park (yes, really!) So, let us move on...

18. Robert Temple – The Sirius Mystery

The Sirius star system is only about 8.6 light years away from the earth.⁵⁰² (The nearest star to us is Proxima Centauri, at a distance of about 4.25 light years⁵⁰³.) Sirius is the brightest star in the sky and because of its brilliance, can sometimes be mistaken for a planet.

In about 1965, Arthur M. Young, inventor of the Bell helicopter, who was a friend of Temple, pointed out a chapter about the Dogon in a book entitled “African Worlds,” by Marcel Griaule and Germaine Dieterlen, eminent anthropologists of the time. (On page 63-4 of [Carl James’ “Science Fiction and the Hidden Global Agenda - Omnibus Edition”](#)⁷⁷ he talks about the group of friends that Robert Temple was part of.) In the translated version of the French texts, Young pointed out a particular passage to Temple, which talked about the star Sirius being important in Dogon culture. Intrigued, Temple investigated further – and wrote [the “Sirius Mystery”- a scholarly book, which was first published in 1976](#)⁵⁰⁴, after several years of ongoing research. The book shows clearly how The Dogon, living in Mali, have some detailed astronomical knowledge about the Sirius Star System, which could only be obtained by prolonged observations using a telescope. How did they get this knowledge?

Though the “Sirius Mystery” contains a wealth of detailed information about Egyptian, Greek and Sumerian mythology, referencing many different sources, the basics of what the Dogon appear to know are simple enough to describe.

“Star Facts”

The Dogon know that

- Saturn has rings (not visible without a telescope)
- Jupiter has moons and they have a depiction appearing to show them.
- Stars and planets move in different ways
- Sirius has an “invisible” companion star – called Digitaria - which has a 50-year orbit around the main star.
- The shape of the orbit is an ellipse (egg-shaped).
- Digitaria (which we call Sirius B) is a “dark and heavy star”
- The stars rotate on their own axes
- Our solar system is part of the milky way.
- Blood circulates in the body (they use this analogy in their description of stars etc).

The Dogon have held this knowledge for hundreds of years or even millennia. Westerners only discovered some of this during and after the renaissance period in Europe – over the last few hundred years. [We can note here that Sirius B was hypothesised by Friedrich Bessel in 1842 and then observed by](#)

Alvan Clark in 1862 – but not photographed until 1970, when Dr Irving W. Lindenblad of the U.S. Naval Observatory in Washington, D.C achieved this difficult task, using a 26-inch/66-centimetre refractor telescope.⁵⁰⁵

Sirius B is indeed “dark and heavy,” being a white dwarf star. In their culture, this is regarded as Sacred knowledge. But why is Sirius significant to them? Why is Sirius B (Digitaria) more important to the Dogon when it is 100 times dimmer than Sirius A? We will come to that shortly, but for the moment will note, as Temple does in the first chapter of his book, an earlier veiled reference to the story of the Dogon by none other than our friend Dr Carl Sagan (whom I discussed in “[Secrets in the Solar System.](#)”⁹⁰)

Sagan Again

On page 453 of [the Sagan-Shklovsky 1966 book “Intelligent Life in the Universe,”](#)⁵⁰⁶ we can read Shklovsky’s words:

As another example, the people of sub-Saharan Africa, who had no written language until the colonial period, preserved their history primarily through folklore. Such legends and myths, handed down by illiterate people from generation to generation, are in general of great historical value.

Moving away, slightly, from the Dogon story Sagan writes, on Page 455 of this book:

Some years ago, I came upon a legend which more nearly fulfils some of our criteria for a genuine contact myth. It is of special interest because it relates to the origin of Sumerian civilization. Sumer was an early—perhaps the first—civilization in the contemporary sense on the planet Earth. It was founded in the fourth millennium .. or earlier. We do not know where the Sumerians came from. Their language was strange; it had no cognates with any known Indo-European, Semitic, or other language, and is understood only because a later people, the Akkadians, compiled extensive Sumerian-Akkadian dictionaries.

The successors to the Sumerians and Akkadians were the Babylonians, Assyrians, and Persians. Thus, the Sumerian civilization is in many respects the ancestor of our own. I feel that if Sumerian civilization is depicted by the descendants of the Sumerians themselves to be of non-human origin, the relevant legends should be examined carefully. I do not claim that the following is necessarily an example of extraterrestrial contact, but it is the type of legend that deserves more careful study.

Taken at face value, the legend suggests that contact occurred between human beings and a non-human civilization of immense powers on the shores of the Persian Gulf, perhaps near the site of the ancient Sumerian city of Eridu, and in the fourth millennium.

So, before Temple, before Von Daniken and before Sitchin (discussed later), we have Carl Sagan laying out the idea of ancient extra-terrestrial contact... I can’t help finding this fact to be intensely interesting!

Sirius

In Chapter 2 of his book, Temple begins to explore the significance of Sirius in Egyptian mythology (which no one disputes, it seems). For example, Temple writes:

The heliacal rising of Sirius was so important to the ancient Egyptians (as indeed it is to the Dogon as well¹) that gigantic temples were constructed with their main aisles oriented precisely towards the spot on the horizon where Sirius would appear on the expected morning. The light of Sirius would be channelled along the corridor (due to the precise orientation) to flood the altar in the inner sanctum as if a pin-pointed spotlight had been switched on. This last of light focused from a single star was possible because of the orientation being so incredibly precise and because the temple would be otherwise in total darkness within. In a huge, utterly dark temple, the light of one star focused solely on the altar must have made quite an impact on those present. In this way was the presence of the star made manifest within its temple. One such temple to the star Sirius was the temple of Isis at Denderah⁵⁰⁷.

(I've added the reference at the end here.) In the same chapter, Temple mentions the Anunnaki and a possible link to Sirius. Also, in Egyptian Mythology, Anubis is the Egyptian god with the head of a dog (or jackal) and that, of course, Sirius has throughout history been known as the “Dog star” (I will also “throw in” that the Mali tribe are called the Dogon – but this must be a coincidence really, as “dog” is an English word!)

Temple also notes that there are repeated references to a group of 50 Anunnaki in various Myths (but they don't really do anything). For example, those which mention “50 sons” or “50 daughters of Danaos” or the “50-oared Argo boat”). He notes that the monsters Cottus, Briareus, and Gyges of Greek mythology each had “fifty heads,” and the Greek goddess Athena had “fifty Pallantids.” He concludes that the recurrence of the number 50 relates to the 50-year orbit of Sirius B around Sirius A. Temple also points out some references to the number 49 and he suggests this may also relate to the orbital period of Sirius B – as it has been measured at *between* 49 and 50 years.

Temple goes on to argue:

Sirius was the most important star in the sky to the ancient Egyptians. The ancient Egyptian calendar was based on the rising of Sirius. It is established for certain that Sirius was sometimes identified by the ancient Egyptians with their chief goddess Isis. The companion of Isis was Osiris, the chief Egyptian god. The ‘companion’ of the constellation of the Great Dog (which includes Sirius) was the constellation of Orion. Since Isis is equated with Sirius, the companion of Isis must be equated, equally, with the companion of Sirius. Osiris is thus equated on occasion with the constellation Orion. We know that the ‘companion of Sirius’ is in reality Sirius B. It is conceivable that Osiris-as-Orion, ‘the companion of Sirius’, is a stand-in for the invisible true companion Sirius B.

In chapter 3, Temple points out the similarity between the Egyptian and Sumerian Calendars – both divided into 12 months, of three 10-day weeks. They also associated a constellation with each week (a bit like our modern

Zodiac). He argues that such a complex system means there must be a strong link between the two cultures. Aspects of a month-based calendar are also referenced in the Babylonian creation myth “Enuma Elish,” which we will discuss later.

Fish People

In chapter 5 temple discusses further aspects of the mythology in relation to a “Fish God”:

...we have our amphibious creature Oannes, identified now with the god Enki, who in Sumerian myth did indeed reside at the bottom of the Abzu, or Abyss, in fresh (not salt) water. It was, in fact, the god Enki who assisted man before the flood came by warning the proto-Noah of the Sumerian deluge story to build his ark. He thus fulfilled the function of the special presiding deity of the Hebrews, the Jehovah of the Old Testament. How many Jews know that their god was originally amphibious?

Temple shows the picture below ([although I got this from a different source](#)⁵⁰⁸). He notes:

The amphibious creature Oannes, who brought civilization to the Sumerians, is sometimes equated with the god Enki (Ea) who ruled the star Canopus of the Argo. Enki is a god who sleeps at the bottom of a watery abyss, reminiscent of Oannes who retired to the sea at night. Enki is also the god responsible for the ark in those early tales of the Sumerians and Babylonians from which the Biblical ark and deluge story was derived.

Temple also notes that there is a parallel with the Greeks’ Nereus who was “the old man of the sea.” The Dogon mythology is similar, then – in that they say that the “Fish God” came from the Sirius system, and “brought civilisation to the earth.” In chapter 8, Temple tells us about Berossus, a Babylonian Priest:

In his work, Berossus describes his country’s tradition of the origins of its civilization. And the tale is a strange one. For a group of alien amphibious beings were credited by the Babylonians with having founded their civilization.

Temple includes a description by Berossus (as given in work by Alexander Polyhistor):

The whole body of the animal was like that of a fish; and had under a fish’s head another head, and also feet below, similar to those of a man, subjoined to the fish’s tail. His voice too, and language, was articulate and human; and a representation of him is preserved even to this day... When the sun set, it was the custom of this Being to plunge again into the sea and abide all night in the deep; for he was amphibious.

Temple also states that “the Dogon have a tradition that their Nommos breathed through their clavicles.”

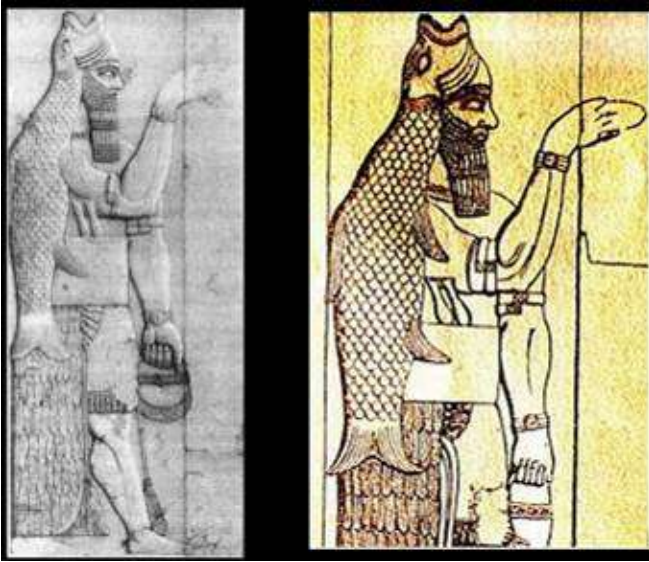

509

Fish-garbed priest bas-relief on temple of the god Ninurta (Saturn) at Kalhu (biblical Calah), ca. 883-859 BCE Assurnasirpal II (p. 83. fig. 65.” Anthony Green. Gods, Demons and Symbols of Ancient Mesopotamia, An Illustrated Dictionary. London, British Museum, in association with the University of Texas Press. Austin. 1992. ISBN 0-292-70794-0.)



510

It seems that Fish People/symbolism is not unique in this bas-relief. (Also note the “fish person” is carrying some type of ring or bag.)

Temple reports on the Dogon’s description of “the Nommo” – a race of Fish People. (We can also note here, as do many others, that the Catholic Pope wears a Mitre Hat as part of his normal dress/costume. [This bears a striking resemblance to a fish’s head/mouth](#)⁵¹¹.)

In chapter 8, he writes:

Let us take a look now at what the Dogon tribe have to tell us about the amphibious creatures who are credited with founding their civilization as well, and who seem to have come from Sirius.



Before we talk a little more about the Dogon and the Nommo, we can also note, not only the tales of mermaids and mermen in Western cultures, but several other references in mythologies of different countries to “fish people” – which were shown in Temple’s 1998 updated “Sirius Mystery” book. [Fuxi and Nüwa \(left\) appear in Chinese Myths – according to a travel website](#)⁵¹², they were “the god and goddess who created the mankind. They have snakelike tails and they are siblings.” This myth is explored further in a 2008 article called [“Nüwa and Fuxi in Chinese Mythology: Compass & Square”](#)⁵¹³:

Some have even suggested that “Nüwa” might be related to “Noah” from the Genesis account, with some parallels between the accounts, such as Nüwa’s sealing of the sky with five colored stones connected with Noah’s rainbow.

Returning to the Nommo and the Dogon’s mythology, later in chapter 8 of the “Sirius Mystery,” Temple continues:

The Nommo is “the monitor for the universe,” the “father” of mankind, guardian of its spiritual principles, dispenser of rain and master of the water generally.

Not all the Nommos came to Earth. The “one” called Nommo Die, or “Great Nommo”, remained “in heaven with Amma, and he is his vicar”. He manifests himself in the rainbow, which is called “path of the Nommo”. He is guardian of the “spiritual principles of living creatures on Earth”. There are three other distinct kinds of Nommo, each personified as an individual. There is the Nommo Titiyayne, “messenger” (or deputy) of the Nommo Die ... he (executes) the latter’s great works. The Nommos who came to earth in the spaceship are presumably of this class.

Temple describes how the Dogon tell of the landing of the Nommo’s ship or “ark.”

The descriptions of the landing of the ark are extremely precise. The ark is said to have landed on the earth to the north-east of Dogon country, which is where the Dogon claim to have come from (originally, before going to Mande) and that is, of course, the direction of Egypt and the Middle East in general...

Temple shows a Dogon image of the ship landing –

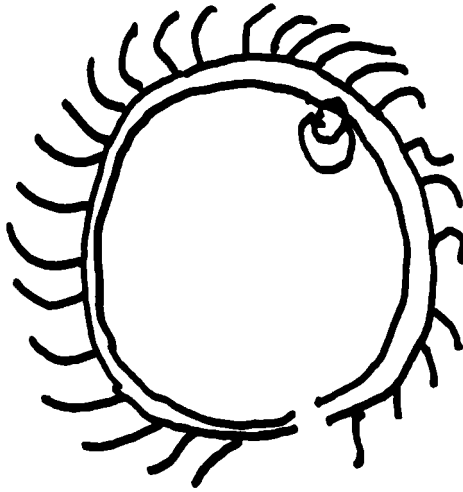

Reproduction of Dogon drawing of Nommo “Ark” (ship)

Temple writes:

The Dogon describe the sound of the landing of the ark. They say the “word” of Nommo was cast down by him in the four directions as he descended, and it sounded like the echoing of the four large stone blocks being struck with stones by the children, according to special rhythms, in a very small cave near Lake Debo. Presumably a thunderous vibrating sound is what the Dogon are trying to convey. One can imagine standing in the cave and holding one’s ears at the noise. The descent of the ark must have sounded like a jet runway at close range.

The Dogon describe that “The ark landed on the Fox’s dry land and displaced a pile of dust raised by the whirlwind it caused.” They continue: “The violence of the impact roughened the ground ... it skidded on the ground.” It is said of Nommo, or more probably of his ark: “He is like a flame that went out when he touched the earth”. They say: “The Nommo was “as red as fire” . . . when he landed, he became white”.

Temple then describes:

After the ark had landed, according to the Dogon, an interesting series of events took place which make a great deal of sense if one remembers that amphibious creatures were inside. Something described both as a “horse” and just simply as a “quadruped” appeared which pulled the ark with ropes to a hollow. “This stage, momentarily, transformed the ark into a chariot drawn by a quadruped with ropes.” The hollow then filled with water.

Was this water coming out of the craft? Was their ship filled with water as they travelled?

The Son of God?

On page 32 of “The Sirius Mystery,” Temple notes of the Dogon’s beliefs:

The parallels with Christ are extraordinary, even extending to Nommo being crucified on a tree, and forming a eucharistic meal for humanity and then being resurrected.

In chapter 8, Temple gives more details:

A third class of Nommos are represented by O Nommo, "Nommo of the pond". "He will be sacrificed for the purification and reorganization of the universe ... He will rise in human form and descend on Earth, in an ark, with the ancestors of men . . . then he will take on his original form, will rule from the waters and will give birth to many descendants."

The name Nommo comes from a Dogon word linked to the root nomo, "to make one drink". It is said: "The Nommo divided his body among men to feed them; that is why it is also said that as the universe "had drunk of his body" the Nommo also made men drink. He also gave all his life principles to human beings." He was crucified on a kilena tree which also died and was resurrected.

If you are not familiar with how stories similar to that of Christ are repeated in many religions, you can refer to [the work of D.M. Murdoch](#)⁵¹⁴.

Temple also describes the Dogon's equivalent of the devil or the Egyptian "Set:"

The fourth Nommo is the naughty disrupter named Ogo, or Nommo Anagonno. "As he was about to be finished (being created) he rebelled against his creator and introduced disorder into the universe. Eventually, he will become the Pale Fox (le Renard Pale) which is the image of his fall."

Staying in the area of religions – did certain rituals still practiced in some modern-day religions have their roots in older ones, like the Dogon's? That is to say that several times in his book, Robert Temple notes the following:

"It is noteworthy that the Dogon ceremony of the Sigui, which is connected with the Dogon Sirius-mysteries, centres largely round rites of circumcision."

Origin of the Dogon and Geodetics

Temple notes that the Dogon state they are not natively from Mali and Temple discusses a possible connection to Libya, which also has mythology that the people there were descended from the "Argonauts" – which appears to link back to the Anunnaki, if you follow some of Temple's connections.

Temple also goes to some length to show the Geodetic alignment of ancient settlements. He argues that this is also relevant to a kind of "global projection" of the constellation of "the boat" – The Argo – which is connected to Sirius. Temple notes:

Dodona is exactly 8° of latitude north of Behdet. Delphi is exactly 7 deg. north of Behdet. Delos (another important early oracle centre, vanished by classical Greek times) is exactly 6 deg. north of Behdet. Behdet was the Greenwich of the ancient world prior to 3200 B.C. and was used as a geodetic headquarters. Associated with nearby Mount Ararat as a mystery-centre was the now little-known site of Metsamor. Mt Ararat is 8 deg. north of Behdet and on the same parallel as Dodona. A site on Kythera is known to have connections with early dynastic Egypt as a religious centre and is about 5 deg. north of Behdet.

The island of Thera may, however, have been an oracle centre. It was destroyed by a famous volcanic eruption in Minoan times. All these sites were revealed as a pattern now termed a 'geodetic octave' by the projection on the globe of the Argo, which is connected with Sirius. Sirius was not only the element of the most sacred traditions of the Dogon and the ancient Egyptians, but apparently of the entire civilized and cosmopolitan Mediterranean world prior at least to 3000 B.C. and probably well before 3200 B.C.

Temple on Flying Saucers and “The Home Planet”

Temple states

At this point I should make it clear that I do not believe that spaceships from extraterrestrial civilizations are flitting through the skies at this moment. I am not a 'flying saucer' enthusiast.

I was disappointed when I read this remark, and a later one referring to “the lunatic fringe.” He mentions that antigravity drives may be impossible and thinks rockets would more likely be used instead. On a similar theme, he references the moon landing in two or three places. Of course, I can “forgive” him for this, due to the amazing information he managed to compile.

In chapter 9, Temple speculates about the environment of the Nommo’s (Sirian’s) home planet, and their strengths and weaknesses compared to humans. Temple suggests that with Sirius A being brighter and hotter than our sun, it may mean that an aquatic existence on their planet was favoured (it being too hot on the land). If what the Dogon says is true, the Nommo must also have adapted to both breathe air and breathe under water.

Sirius C?

Temple also speculates about the orbit of the Dogon’s “Sirius C”. The Dogon state that the third star has a 32-year orbit. However, based on Kepler’s laws of motion, it seems that most configurations of a system of 3 stars would become unstable. In the 1998 updated version of his *Sirius Mystery Book*, Temple states that Sirius C was discovered in 1994. However, this is not quite true. In a 1994 paper called “Is Sirius a triple star?” by French Astronomers D. Benest and J. L. Duvent⁵¹⁵, they carefully analysed observations of the Sirius system. In their conclusion, they do not claim to have *proved* the existence of “Sirius C,” they just suggest there could be another star in the system, which has a 6-year orbit around Sirius A. (The text below appears to be an imperfect translation from French):

... one negative observation does not imply that the object does not exist, for this conclusion could be stated only if no detection at all occurs after regular observations during at least half a period of Sirius C, i.e. 3 years... new techniques — for example: adaptive optics—allow us to observe faint stars with good signal/noise ratio. We know that Sirius A is so bright that it rapidly saturates any sensitive infrared camera. Fortunately, the recent progress in stellar coronagraphs let us hope that this technique, together with the use of adaptive optics, could finally allow us to find Sirius C, if it exists, or at least, give a maximum value for its luminosity, and hence for its mass.

Also, their proposed orbital period of 6 years is different to the Dogon's stated period of 32 years. [Indeed, even more recent research, published in a paper by Howard Bond, has not found any evidence of Sirius C⁵¹⁶ either,](#) despite more observations since the 1994 Benst/Duvent paper.

However, this does not detract too much from the case that Temple constructed all those years ago – it is possible that the 32- year orbit for Sirius C is historical information – there was some other kind of object in the system at one time, which is no longer there. Or, the object is there, but is undetectable for unknown reasons – just as Sirius B remained undetectable to westerners for centuries.

Temple Harassed

In the first chapter of the updated 1998 version of “The Sirius Mystery”, Temple describes various experiences following the publication of his 1976 book. These experiences included both positive and negative criticism – but also included attention from both the CIA and MI5. Temple was surprised by this. He also reported that it did have a negative impact on his career. He reports how an unnamed person who worked for NASA who telephoned various people – such as Arthur C Clarke and Isaac Asimov - to malign Temple (who was friends with Arthur C Clarke).

The Dogon and Modern Quantum Theory

[In a 2017 presentation,](#)⁵¹⁷ researcher Laird Scranton suggests that the Dogon's knowledge also extends to an understanding of concepts described in Modern Physics – such as the idea of [Wave Particle Duality](#)⁵¹⁸. Scranton suggests that they know about how matter is created and have a symbolic tradition to describe this. [Scranton has done a great deal of research](#)⁵¹⁹ which seems to strengthen the links between the Dogon and the ancient Egyptians.

However, this pre-supposes that the theories contained in Modern Physics are correct – for example, Scranton suggests the Dogon know about black holes, and their effects, [though some would argue that black holes do not exist – the effects attributed to them could, for example be explained by plasma discharge phenomena](#)⁵²⁰. It is easy to end up going in circles with these lines of research!

Conclusion

I think that Temple has shown that there is strong evidence that a race of amphibious beings, from the Sirius system, interacted with human beings at least 5,000 years ago. Echoes of this knowledge survive in modern cultures and religions. We will discuss other aspects of this conclusion in the next section and consider what some of this interaction might have involved.

19. Zechariah Sitchin, The Twelfth Planet and the Creation of Humans



A now very well-known figure in the Ancient Alien field of research is [Zechariah Sitchin](#)⁵²¹ (1920–2010), who [published his first book “Twelfth Planet”](#)⁵²² in 1976 – 8 years after EVD’s “Chariots” book and the same year as Temple’s “Sirius Mystery” book. I first became aware of Sitchin’s work through my friend [Lloyd Pye \(1946–2013\)](#)⁵²³, who wrote a book called [Everything You Know is Still Wrong \(revised edition published in 2017\)](#)⁵²⁴, which drew on

significant elements of Sitchin’s work. (I will talk more about Lloyd Pye later).

I will give an overview of Sitchin and his work, which is partly based on a [summary](#)⁵²⁵ of a [1993 interview he gave to a magazine called “Connecting Link”](#)⁵²⁶

Zechariah Sitchin was born in Russia and raised in Palestine and he learned a great deal about modern and ancient Hebrew and other Semitic and European languages. He also studied the Old Testament and the history and archaeology of the Near East.

Sitchin graduated from the University of London in 1941, majoring in economic history, so it appears he did not formally study (i.e. at University) the languages and ancient history he has written about. [He worked as a journalist and editor in Israel between 1939 and 1952. He also did some work in the USA](#)⁵²⁷ between 1949 and 1952, when he was executive director of the American-Israel Chamber of Commerce and Industry.

Whether he is talking about the evolution of humans or “Nibiru,” Sitchin stated that he based his main assertions and conclusions on his interpretations of the Sumerian texts and some interpretations from the Old Testament (mainly the book of Genesis). It is worth noting that in Sitchin’s “Twelfth Planet” book, the word “alien” never appears in the context of “extraterrestrial beings.”

It is also worth noting here that in “Twelfth Planet,” Sitchin says, a few times, “we believe” but doesn’t say who the other person or people is/are other than himself that are believing these things. The book isn’t co-authored with anyone either.

Another problem with the book (although it is a problem almost everywhere else, of course) is that Sitchin references the Apollo Moon landings as if they were a real event when the evidence now shows they did not happen as claimed.

The primary claims that Sitchin lays out in “Twelfth Planet” are as follows:

- The Sumerian texts talk about the Anunnaki coming to the earth in 450,000 BC.

- They came from a planet called Nibiru – which became one of 12 main bodies in our solar system (including the Sun and the Moon).
- The earth formed when a planet called Tiamat was hit by satellites of another planet called Marduk. Marduk “became” Nibiru.
- They created homo sapiens from beings that were already on the earth and they used their own genes to do this.
- They knew that, in about 10,000 BC, there would likely be a great flood caused by a large section of the Antarctic Ice Sheet breaking off and causing an enormous tidal wave.
- They told one particular human that this would happen and that he should “build a boat.”
- After the flood, they helped humans, using genetic engineering, to domesticate animals and develop agriculture/growing of crops.
- They appointed kings as intermediaries between themselves and the rest of the human race.
- Cities in Sumer and Egypt developed after the great flood, which wiped out almost everything else.

Nefilim or Nephilim

According to Sitchin, his investigations of the Sumerian works came about as a result of questions he had, early in his life, about the Nephilim (or Nefilim) of the Bible. He wanted to know who they were. Sitchin’s statements in the 1993 interview, referenced above, say the same thing as he does in the introduction of his “Twelfth Planet” book:

My starting point was, going back to my childhood and schooldays, the puzzle of who were the Nephilim, that are mentioned in Genesis, Chapter six, as the sons of the gods who married the daughters of Man in the days before the great flood, the Deluge.

*The word Nephilim is commonly, or used to be, translated giants... Those were the days when there were **giants** upon the earth. I questioned this interpretation as a child at school, and I was reprimanded for it because the teacher said, “You don’t question the Bible.”*

*But I did not question the Bible; I questioned an interpretation that seemed inaccurate, because the word, Nephilim (or Nefilim), the name by which those extraordinary beings, “the sons of the gods” were known, means literally, **“Those who have come down to earth from the heavens.”***

This is where we start to run into some difficulties – which plague this sort of research. Interpretations of a word like this are sometimes subjective and in cases like this definition, hotly debated.

For example, a [website called “Bible Study Tools”](#) states⁵²⁸:

This word, translated “giants” in the King James Version, but retained in the Revised Version (British and American), is found in two passages of the Old Testament—one in Genesis 6:4, relating to the antediluvians; the other in

Numbers 13:33, relating to the sons of Anak in Canaan. In the former place the Nephilim are not necessarily to be identified with the children said to be borne “the daughters of men” to “the sons of God” (Genesis 6:2,4); indeed, they seem to be distinguished from the latter as upon the earth before this unholy commingling took place (see SONS OF GOD). But it is not easy to be certain as to the interpretation of this strange passage. In the second case they clearly represent men of gigantic stature, in comparison with whom the Israelites felt as if they were “grasshoppers.” This agrees with Genesis 6:4, “the mighty men that were of old, the men of renown.” Septuagint, therefore, was warranted in translating by gigantes.

As is alluded to above, there is talk of the Nephilim interbreeding with humans. This is also described in [another article on the Christian Apologetics & Research Ministry](#)⁵²⁹:

There is debate over the identity of the Nephilim in Genesis 6. Some people believe that the Nephilim are the offspring of sexual relations between fallen angels and human women. In support of this view Jude 6 is often referenced: “And angels who did not keep their own domain, but abandoned their proper abode, He has kept in eternal bonds under darkness for the judgment of the great day,” (Jude 1:6). This would mean that the fallen angels (The Hebrew naphal means ‘to fall’) had sexual intercourse with women.

So, one could argue that Sitchin’s definition might be acceptable, because if someone or something “falls,” then it is obviously “coming down.” So, if they can be called “fallen angels,” that implies they did “come down from above.” However, we should consider the different meanings of “fallen” – in that we can *physically* fall down – stairs, a well, a hole etc, or we can “fall from grace” – i.e. our reputation and standing is damaged or lowered. We therefore can’t automatically assume this is a reference to another race of beings landing in one or more spaceships. Dr Mike Heiser (whom we shall mention again later) agrees that Sitchin has misappropriated the definition of Nephilim. [Heiser points out that Sitchin mistranslated the word in his “Stairway to Heaven” book – and Sitchin should have realised that what was meant in the context that Sitchin used was probably the word “watchers.”](#)⁵³⁰ (So who were these “watchers”?)

Twelve Planets?

In his first book, “The Twelfth Planet,” Sitchin argues that there is an - as yet – undiscovered planet in our solar system. In chapter 6 of “Twelfth Planet,” he argues that the way the Sumerians characterised planets meant that they would include the Sun and our moon as a planet, making a total of eleven in our solar system. He states that the Sumerians spoke of an additional (twelfth) planet which was the home planet of the Nephilim. He then goes on to describe that people from that planet came to earth almost half a million years ago and “did many of the things about which we read in the Bible, in the book of Genesis.” Sitchin said:

All the ancient scriptures, the Bible, the Greek myths, the Egyptian myth and texts, the pyramid texts, everything, led to the Sumerians, whose civilization

was the first known one—six thousand years ago. I focused on Sumer, the source of these legends and myths and texts and information.

I learned to read the cuneiform Sumerian texts and came upon their persistent and repeated statements that those beings, whom the Sumerians called Anunnaki, came to earth from a planet called Nibiru. The planet was designated by the sign of the cross and Nibiru meant “planet of crossing.”

The question thus shifted in my research from who were the Nefilim and the Anunnaki, to what planet is Nibiru? Forced to become proficient in astronomy, I had to learn enough about it to deal with the subject. I found out that the scholars were divided. Some said it (Nibiru) was Mars, which of course was described and known to the ancient people, and others said, no, it was Jupiter.

But Sitchin then says he just “woke up” with the idea that Nibiru was a planet that came between Mars and Jupiter periodically (i.e. he didn’t really work this out from specific measurements, data or observations of the night sky.)

Sitchin also argues:

They knew about Uranus and Neptune and described them, and they knew about Pluto. They were proficient in mathematics and, in many respects, their knowledge surpassed modern times. They said, “All that we know was told to us by the Anunnaki.”

Sitchin also argues that Pluto was shown by the Sumerian writings to be between Saturn and Uranus. Sitchin argues that Nibiru exists and it travels in a highly elliptical orbit (discussed more later). He argues that if Nibiru exists, then so must the Anunnaki – but I would say that this, like a fair few (but not all) of Sitchin’s claims, assumes a great deal.

A “Tour of the Twelfth Planet...”

In this section, I will try to summarise the most salient parts of Sitchin’s 1976 book and give an assessment of the strength of the evidence Sitchin presents in this work. One running problem with the book is that though he includes a list of references, he does not clearly name the specific source of many of the quotes he uses – particularly when he is quoting ancient scriptures. The images are labelled and described, but generally not referenced back to their original sources. The book is an easy read and the information is laid out clearly and the book is well-structured, as is each individual chapter.

In the first chapter, he comments on the rapid evolution of homo sapiens and he discusses certain anomalous archaeology. In chapter 2, he comments on the various advanced aspects of Sumerian culture wherein they had the first examples of complex writing, an alphabet, mathematics, cooking, food production, medicine – and there does not seem to have been an earlier civilisation. Sumerian culture had organised education, laws, written music and other attributes we associate with more modern civilisations. This is highly significant and not disputed by mainstream scholars.

In chapter 3, Sitchin explores the myths about gods – for example, he discusses anthropomorphic Greek gods. He implies these Greek gods came from the near east (i.e. Sumer) to Greece (e.g. Zeus swam the Mediterranean

to get to Greece). Sitchin also mentions Vedas (ancient Indian Scripture) and the Indian/Hindu gods and states the “Vedas were written in a very ancient Indo-European language,” he does not give a source for this, but this statement seems to be correct.⁵³¹ Sitchin also notes the similarity between Vedic and Greek pantheons. (A pantheon is a group of gods.)

Sitchin also notes the Hittites repeated this theme of there being 12 gods (though referenced sources are limited) and he notes parallels between Greek and Hittite mythologies, with stories of “gods in heaven,” then “coming to earth,” and “battling with dragons.” He argues that based on details in the Hittite accounts, their gods were actually the same as the Sumerian gods (although he hasn’t initially given much detail about the Sumerian gods, so that the reader can compare them). Accepting the similarities between the mythologies, Sitchin argues that the Hurrians were earlier neighbours of the Sumerians and they mingled with them, absorbed their culture then migrated and dominated the Hittites.

Following this theme, Sitchin discusses the [Canaanites and their pantheon – which include the god El, who was said to be “the father of Man.”](#)⁵³²

Of course, this idea of a “god being father of man” (a creator) is fundamental to many religions and one which deserves ongoing study.

Sitchin states the Egyptians originally had 12 gods, ruled by Ra (identified with the Sun, in most writings). Sitchin states that although the Egyptians used a decimal system for counting things, they used 12 for “celestial matters”. As we would normally read in other works, Sitchin states that the original rulers of Egypt were gods. However, according to Sitchin these “gods” actually “came by boat from the south” via the Red Sea (he argues that they originally came from Sumer).

Sitchin identifies another group called the [Amorites – who also had the same or a very similar pantheon as the Egyptians.](#)⁵³³

In chapter 4 of *Twelfth Planet*, Sitchin writes about what he says is the history of the Sumerian gods – and how they had intercourse with lesser goddesses – the chapter reads a bit like a “soap opera”. He tells the story of how some of the gods had children. Again, figures/pictures and quotations are not fully referenced/sourced and alternative interpretations are not given. At the end of this chapter, Sitchin shows the hierarchy of the Sumerian gods in a diagram.

In chapter 5, Sitchin writes more about the Nefilim and he describes them as “People of the Fiery Rockets” (a rather simplistic label, which we will discuss further, below). He argues that ancient artefacts, of which he includes pictograms, show that the Sumerians built a 3-stage rocket like the Saturn IV used in the Apollo missions... He shows the mission patch for Apollo 11. (Fig 79). He claims that the word “shem” means “rocket” and that a group of humans built and/or flew their own “shem” (more on humans later!) Around this point, Sitchin mentions the book of Ezekiel and, as we mentioned earlier, the work of Josef F. Blumrich who thought Ezekiel was describing men in

space suits and the landing of their helicopters. (This sounds silly, but the descriptions are interesting.)

In chapter 7 (itself called “Twelfth Planet”), Sitchin correctly points out that the Solar/Lunar calendar that we use now goes back a long way. He rightly argues that whoever developed this calendar had a more detailed knowledge of astronomy (based on spherical geometry) than was evident in some periods of later Greek and Roman history, for example. Sitchin argues that the Greek astronomer Hipparchus derived knowledge of the earth’s processional motion from the Sumerian knowledge.

We can note that the date given for many religious festivals – such as Ramadan and Divali and Easter are based on a lunar calendar, not specifically or solely on the activities or actions of prophets and other religious figures. In fact, it appears that a fair number of allegories, stories and myths in most modern and popular religions relate to aspects of astronomy and astrology far more than is ever discussed in those same religions.

Enuma Elish

Also in chapter 7, Sitchin refers to [Enuma Elish – the Babylonian Creation Myth](#)⁵³⁴ - and argues this reveals something about the Anunnaki, the history of the Solar System and the creation of humans. He asserts:

There is enough evidence to show that the Babylonian version of the epic was a masterful religious-political forgery of earlier Sumerian versions, in which Anu, Enlil, and Ninurta were the heroes.

If you read the English translations of the Enuma Elish on their own, you would probably agree that Sitchin’s interpretations seem to be quite a stretch. Is the Enuma Elish myth describing planet formation and events in our solar system? Wars of the gods? Or a mixture of both things? I can’t see, for example, how Sitchin would be able to state this with any confidence:

Appearing from outer space, Marduk was still a new-born planet, belching fire and emitting radiation. “When he moved his lips, fire blazed forth.”

Whilst it is true that the Enuma Elish mentions Tiamat or “Tiamut” and Anu and the Anunnaki, how would *the concept of radiation* even be expressed by the Sumerians or Babylonians? Isn’t it making an enormous assumption to say that planet formation is being described in line 5 of Enuma Elish, where it states about Apsu and Tiamat that, “They had mingled their waters together”?

Enuma Elish translations that I read are only about [6500](#)⁵³⁵ and [10000 words](#)⁵³⁶ (depending on the translation) and they are incomplete. Some segments are repeated (word for word) multiple times.

Sitchin Quotes several other sources (e.g. book of Genesis) to try and boost his interpretation of the ancient text, but I can’t really see how Sitchin can make such bold claims with the certainty that he does.

To illustrate my point, consider that in one [translation of the Enuma Elish by L.W. King](#)⁵³⁵, we read:

He sent forth the winds which he had created, the seven of them;

*To disturb the **inward parts of Tiamat**, they followed after him.
Then the lord raised the thunderbolt, his mighty weapon,
He mounted the chariot, the storm unequalled for terror,*

In [another translation by W.G. Lambert](#)⁵³⁶, however the word “thunderbolt” does not appear.

*46~The Four-fold Wind, the Seven-fold Wind, the Chaos-spreading Wind,
theWind.*

47~He sent out the seven winds that he had fashioned,

48~And they took their stand behind him to harass Tia-mat's entrails.

49~Be-I took up the Storm-flood, his great weapon,

50~He rode the fearful chariot of the irresistible storm.

So, is the story about gods or planets – or both? What are the “inward parts of Tiamat”? Entrails of a person, perhaps? I could argue that lines in the story after those above do seem to describe the end of a battle between people - with survivors fleeing or being captured.

In King's translation of the fifth tablet of Enuma Elish, we read:

He founded the station of Nibir [the planet Jupiter] to determine their bounds;

Lambert's translation says:

6~He established the heavenly station of Ne-beru to fix the stars' intervals.

So, it sounds like we *are* dealing with astronomical matters. Indeed, it sounds like one part talks about the creation of our moon. King's translation says:

The Moon-god he caused to shine forth, the night he entrusted to him.

He appointed him, a being of the night, to determine the days;

Every month without ceasing with the crown he covered him, saying:

“At the beginning of the month, when thou shinest upon the land,

Thou commandest the horns to determine six days,

And on the seventh day to divide the crown.

Lambert's says

12~He created Nannar, entrusting to him the night.

13~He appointed him as the jewel of the night to fix the days,

14~And month by month without ceasing he elevated him with a crown,

15~(Saying,) “Shine over the land at the beginning of the month,

16~Resplendent with horns to fix six days.

17~On the seventh day the crown will be half size,

18~On the fifteenth day, halfway through each month, stand in opposition.

So, I can agree that this appears to be talking about the creation of the Moon – or at least the lunar calendar.

Now we come to the creation of humans... in King's translation of the sixth tablet we read:

*When Marduk heard the word of the gods,
His heart prompted him and he devised a cunning plan.*

He opened his mouth and unto Ea he spake

That which he had conceived in his heart he imparted unto him:

“My blood will I take and bone will I fashion

*I will make man, that man may
I will create man who shall inhabit the earth,
That the service of the gods may be established, and that their shrines may
be built.*

Lambert's translation basically says the same thing:

*1~When Marduk heard the gods' speech
2~He conceived a desire to accomplish clever things.
3~He opened his mouth addressing Ea,
4~He counsels that which he had pondered in his heart,
5~"I will bring together blood to form bone,
6~I will bring into being Lullû, whose name shall be 'man'.
7~I will create Lullû—man
8~On whom the toil of the gods will be laid that they may rest.*

We can read elsewhere, in non-Sitchin sources, that Marduk and Enki (one of the Anunnaki) were the co-creators of man.⁵³⁷

It can be argued that in the seventh tablet, it states how Marduk was actually responsible for initiating Agriculture. King's translation reads:

*O Asari, [Marduk] "Bestower of planting," "Founder of sowing"
"Creator of grain and plants," "who caused the green herb to spring up!"
O Asaru-alim, [Marduk] "who is revered in the house of counsel," "who
aboundeth in counsel,"
The gods paid homage, fear took hold upon them!*

Similarly, in Lambert's translation we read:

*57~(24) Enbilulu is he, the lord who supplies them abundantly,
58~Their great chosen one, who provides **cereal offerings**,
59~Who keeps pasturage and watering in good condition and established it
for the land,
60~Who opened watercourses and distributed plentiful water.
61~(25) Enbilulu-Epadun, lord of common land and . . ., let them [call him]
secondly,
62~Canal supervisor of heaven and netherworld, who sets the furrow,
Who establishes clean arable land in the open country,
63~Who directs irrigation ditch and canal and marks out the furrow.
64~As (26) Enbilulu-Gugal, canal supervisor of the water courses of the
gods, let them praise him thirdly,
65~Lord of abundance, profusion, and huge stores (of grain),
66~Who provides bounty, who enriches human habitations,
67~Who gives wheat and brings grain into being.
68~(27) Enbilulu-H(egal, who accumulates abundance for the peoples ...*

69~Who rains down riches on the broad earth and supplies abundant vegetation.

70~(28) Sirsir, who heaped up a mountain on top of Tia-mat,

71~Who plundered the corpse of Tia-mat with [his] weapons,

72~The guardian of the land, their trustworthy shepherd,

73~Whose hair is a growing crop, whose turban is a furrow,

74~Who kept crossing the broad Sea in his fury,

To summarise, I am in some agreement with Sitchin that Enuma Elish may have some genuine information about the creation of humans and agriculture (which we will discuss more later). However, I am far less convinced by the stories of the “Twelfth Planet” itself, its orbit and the other suggestions or claims about what happened in our solar system.

Nibiru, the Nephilim and Rockets

Again, in chapter 8, Sitchin argues that Marduk was indeed another planet – but not one of the ones we know in the solar system. It was in fact Nibiru. However, this is not accepted by most other versions of events and it is stated in Britannica.com that “[Jupiter as Marduk’s star.](#)”⁵³⁸ He then just states and illustrates what the orbit of Nibiru is, based on statements in the Book of Job and some Psalms (neither of which contain specific measurements or figures). Sitchin argues that other ancient scriptures (not just Sumerian) describe the approach/passage of another planet, but these references are fairly generalised and not convincing. For example, Sitchin writes:

While such an orbital period cannot be ruled out, the Mesopotamian and biblical sources present strong evidence that the orbital period of the Twelfth Planet is 3,600 years. The number 3,600 was written in Sumerian as a large circle. The epithet for the planet—shar (“supreme ruler”) —also meant “a perfect circle,” a “completed cycle.” It also meant the number 3,600. And the identity of the three terms—planet/orbit/3,600—could not be a mere coincidence.

He makes a tenuous connection to [figures given in a Babylonian King list, showing how long each reigned](#)⁵³⁹, where each kind reigned for a period which was multiples of 3600 years. He then claims that this was the orbital period of Nibiru – and argues that the rulers would travel to/from Nibiru every orbit! Based on these figures, Sitchin suggests the Nefilim first landed on earth 450000 years ago.

In chapter 9 of Twelfth planet, Sitchin builds on earlier assumptions about what the Sumerian texts say about rockets and planets and I have to say that things are re-interpreted to fit his theories. For example, he talks about the Nefilim regularly travelling between the Earth and Nibiru (in their “Fiery Rockets”) and on page 269 he writes:

*Beyond Uranus looms Saturn, a giant planet (nearly ten times Earth’s size) distinguished by its rings, which extend more than twice as far out as the planet’s diameter. Armed with a tremendous gravitational pull and the mysterious rings, **Saturn must have posed many dangers to the Nefilim***

and their spacecraft. This may well explain why they called the fourth planet TAR.GALLU (“the great destroyer”). The planet was also called KAK.SI.DI (“weapon of righteousness”) and SI.MUTU (“he who for justice kills”).

This again is probably totally wrong. Sitchin seems to forget that Jupiter is even larger than Saturn, so unless Sitchin could pin down the timing of where Nibiru was and where Saturn was and *exactly* what path the Nefilim were travelling through the solar system on a given journey, there is no way he could make this interpretation with any certainty.

In a similar vein, he suggests that a fragmented Sumerian tablet is some type of “return route map” for the Nefilim’s craft, due to the astronomical information on the tablet. Whilst the tablet does indeed show some astronomical information, Sitchin does not really say why the Nefilim would need this map carved in stone, or why someone would have thought it important to copy down this information after the event.

More recent research on this tablet has suggested it actually documents an astronomical event – the sighting of an object which was actually [an asteroid which impacted in Austria in 3100 BC](#)⁵⁴⁰. The tablet does seem to be of Sumerian, rather than Babylonian origin, according to the article about the Asteroid impact.

Sitchin also discusses the Winged Disk or Winged Globe iconography. He claims this represents the Twelfth Planet. However, it could be argued that this is another sun symbol – showing massive solar flares, for example. I certainly don’t think there is enough evidence to state this symbol represents a still-undiscovered 12th planet. [A chapter of an online book called “Sacred Texts” considers different forms of this symbol](#)⁵⁴¹, but draws no firm conclusions as to what it represents.

The Garden of Eden and Space Ports

In chapter 10, Sitchin describes how he thinks the Nefilim chose a landing site and a site to build a city. He mentions the area in between the Tigris and Euphrates rivers which appears, according to scholars, to be the area in which the “Garden of Eden” was situated. Sitchin also states (but without references) that the Nefilim utilised oil and petroleum resources and knew about all the different types of petrochemical compounds. Again, this analysis is not referenced. He doesn’t seem to say what they used these compounds for, either.

Also, in chapter 10, Sitchin references Berossus and his account of the “fish-men” – however, he doesn’t really integrate this into his narrative about the Nefilim – for example, he doesn’t say that the Nefilim were the fish-men, nor that they disguised themselves as such. He also talks about a “splashdown” – implying the Nefilim only had technology like the faked Apollo missions – again he assumes reference to chemical rocket technology and never considers that these Nefilim (aliens) might have something much more advanced.

He talks about a “shuttle landing” and tries to map out where a space port and mission control would have been (assuming some kind of organisation similar to NASA). Again, this seems odd or even silly. NASA’s Space Shuttle had its first flight in 1981, but still, of course, used chemical rockets (then just glided back to earth, unpowered). Sitchin seemed to be proposing the Nefilim/Anunnaki had similar technology!

Ancient Gold Mines and Miners

In chapter 11 and elsewhere, Sitchin’s claims that Homo Sapiens was created as a “somewhat intelligent slave miner.” This was, apparently, because the Anunnaki needed to mine gold to “fix” the atmosphere of Nibiru (this is described more in Sitchin’s later works, not “Twelfth Planet”). Again, this conclusion seems a real stretch, considering, for example, the comparison of translations of the Enuma Elish that we looked at earlier. (i.e. how can Sitchin deduce the details of such an activity from uncertain translations?)

Of course, gold has an intrinsic and high value for many reasons (and not just because it is used to make coins and jewellery either), so even if Sitchin is right about the “genetically engineered slave,” it doesn’t mean he is right about Nibiru and its atmosphere!

However, Sitchin is basically correct about the [ancient mines in places like Swaziland in Africa](#)⁵⁴², which could date back as far as 100,000 years, although most sources I looked at gave 43,000 years (but as far as I know, that is way, way before any known European mining, for example).

Interested readers can also review the research and writing of [Michael Tellinger who has definitely discovered some interesting ancient sites in South Africa](#)⁵⁴³, which may also be related to the activities of tribes or a civilisation that were involved in mining – or similar activities – tens of thousands of years ago. However, Tellinger sometimes, like Sitchin, seems to make claims beyond what the evidence shows.

The Creation of Man

In chapter 12 of Twelfth Planet, Sitchin further develops the argument that the Anunnaki created Homo Sapiens 300,000 years ago – as a slave worker. He describes a very interesting portion of the [Epic of Gilgamesh – which is said to be “the oldest story on earth,”](#)⁵⁴⁴ which again comes from Ancient Sumer and was written on eleven or twelve tablets. Earlier, we referenced portions of the Enuma Elish which seem to be telling a very similar story to the creation of Adam and Eve in the book of Genesis. In the “Epic of Gilgamesh” (EOG), Sitchin suggests that the creation of man also involved a “wild man.” In EOG, this “wild man” is called “Enkidu.” It seems to be this particular section which caused Lloyd Pye to think that the “wild man” being described might be a sasquatch or bigfoot and that, somehow, this ties in to how Homo Sapiens came into being. On the first tablet, we read:

His whole body was shaggy with hair, he had a full head of hair like a woman, his locks billowed in profusion like Ashnan. He knew neither people

nor settled living but wore a garment like Sumukan.” He ate grasses with the gazelles and jostled at the watering hole with the animals; as with animals, his thirst was slaked with (mere) water. A notorious trapper came face-to-face with him opposite the watering hole.

Again, parts of EOG do mention the creation of man and it also states:

*Who can say like Gilgamesh: “I am King!”? Whose name, from the day of his birth, was called “Gilgamesh”? **Two-thirds of him is god, one-third of him is human.***

In Twelfth Planet, chapter 12, Sitchin discusses the genetic engineering of the “perfect man” called “Adapa.” He suggests this was only successful, after a number of failed attempts. A plausible explanation for the common imagery of bull-men and lion-men etc is then offered – as being part of the genetic experiments, rather than just mythical/imaginative creatures. Sitchin argues that the tale of the creation of Adapa is covered in at least a Sumerian account and a Babylonian account called [“Creation of Man by the Mother Goddess.”](#)⁵⁴⁵

Sitchin returns to the account in Genesis of Adam and Eve and the part of the story about them gaining certain “godly attributes” and knowledge. He points out that this happened when they realised they were naked – they had become self-aware to a new level. Sitchin then suggests that this was because they were actually the first god/human hybrids that could successfully reproduce.

Sitchin argues the story is probably derived from Sumerian myths (like parts of EOG) but there is no direct analogue that has been found. Sitchin argues the Adam and Eve tale involved the Anunnaki gods Enki and Enlil, due to the use of the “we” when Adam and Eve are talking to the Serpent. Of course, there have been whole books written about the true identity of the Serpent in this story.

[Moving on in the Biblical story, Sitchin argues that the Babylonian’s Utnapishtim \(who appears in the EOG\) is Noah](#)⁵⁴⁶. In EOG, Utnapishtim also built a boat to save him and various animals from a flood. Sitchin suggests that it was Enki who told Utnapishtim about a coming flood – Enki “broke ranks” with the rest of the Anunnaki (but mainly Enlil), who wanted to withhold this information so that mankind would be wiped out. This then, Sitchin suggests, resolves the conflict in the narrative whereby God created but then destroyed his own creation - mankind - with the flood. (That is, Sitchin argues more than one “god” was involved in the story and they were in conflict over what should be done).

The Great Flood

Sitchin argues that the great flood was caused by a large chunk of the Antarctic ice sheet breaking off, around the time of another passage of Nibiru. The Nefilim predicted that this would happen and so they knew a flood was imminent. He suggests this flood occurred between about 10,000 and 8,000 BC – or perhaps 12,000 years ago. This figure is the same as the one

commonly quoted by authors like Graham Hancock, who has looked at evidence from around the world, not just the near East.

During the great flood, the Nefilim, according to Sitchin, temporarily went into orbit in their ships. Why they wouldn't just fly to higher ground somewhere – e.g. the Himalayas or the Alps in Europe, is not discussed.

Agriculture Begins

In chapter 15, Sitchin argues that the Nefilim landed after the flood waters had subsided and it was then that they decided to help the remnants of the human civilisation and give them the technology of agriculture – particularly the growing of crops. (This is described in Genesis as being a “gift” to Noah.) It is true that the domestication of animals seemed to start about 12,000 years ago. Even according to [Britannica.com in 2019](#)⁵⁴⁷, it is not understood how dogs became a domesticated version of a wolf. Sitchin argues that the Nefilim developed cereal crops to give to the population in the Near East. [However, he does not mention that evidence of early crop farming has been found in other areas of the world – such as China, India and South America](#)⁵⁴⁷. To be fair, this may not have been known when Sitchin wrote the book.

Sitchin argues that civilisations in Egypt and the Indus valley were planned or instigated by the Nefilim, following on from the deluge, because their original base in Sumer was destroyed in the flood. Sitchin suggests that the Nefilim then appointed human intermediaries – kings and pharaohs to rule these civilisations Perhaps King [Gilgamesh, whose tomb seems to have been found in 2003](#),⁵⁴⁸ was one example.

Critiquing Sitchin – Dr Mike Heiser

Of course, there is much criticism of Sitchin's work but Dr Mike Heiser, who also is interested in the topics of UFOs and the Paranormal, has been one of the most visible. For example, [he wrote an open letter to Sitchin, asking him to explain more clearly where he “got” his translations](#).⁵⁴⁹ Sitchin did not reply. Many of Heiser's points are, indeed, valid and could and should have been answered by Sitchin. We will reference a few of these here.

[Heiser has shown how people can find references to the Anunnaki in online versions of the original texts](#)⁵⁵⁰. [He also made a video about checking some of the translations that Sitchin used](#)⁵⁵¹. Heiser argues there is no scripture that states the Anunnaki are from Nibiru – and I would accept Heiser's statement as being accurate, based on my own evaluation of “Twelfth Planet” (However, both Nibiru and the Anunnaki are mentioned in, for example, Enuma Elish).

[In a longer piece, Heiser explains that a particular cylinder seal that Sitchin repeatedly references \(VA243\) does not conclusively show a diagram of “12 planets.”](#)⁵⁵²

Heiser argues that what Sitchin calls the Sun and planets isn't the sun, as the Sumerian used a different symbol for the sun (which looks similar).



Cylinder seal VA234 – showing, according to Sitchin – 12 planets

Heiser states that the Sumerians used this symbol (below) to represent the Sun. He writes:

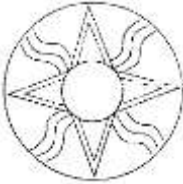

The reader should note immediately that this is NOT the symbol on VA243. VA 243's "pseudo-sun" lacks the wavy lines and is not set inside a circle.

Here is a close-up of the sun (L) and star (R) symbol above. Note that the star in this case has eight points:

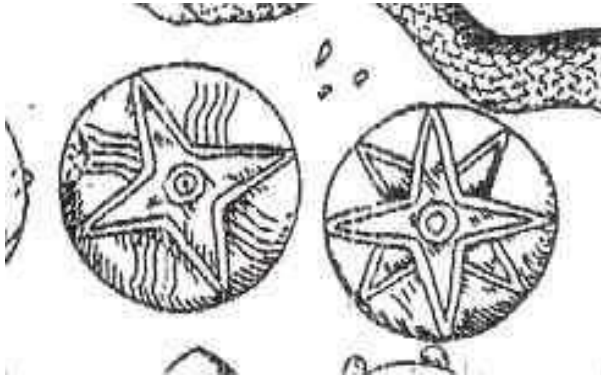

Heiser suggests that what VA243 might show is a representation of the Pleiades, which appear in other Sumerian art, as he shows.

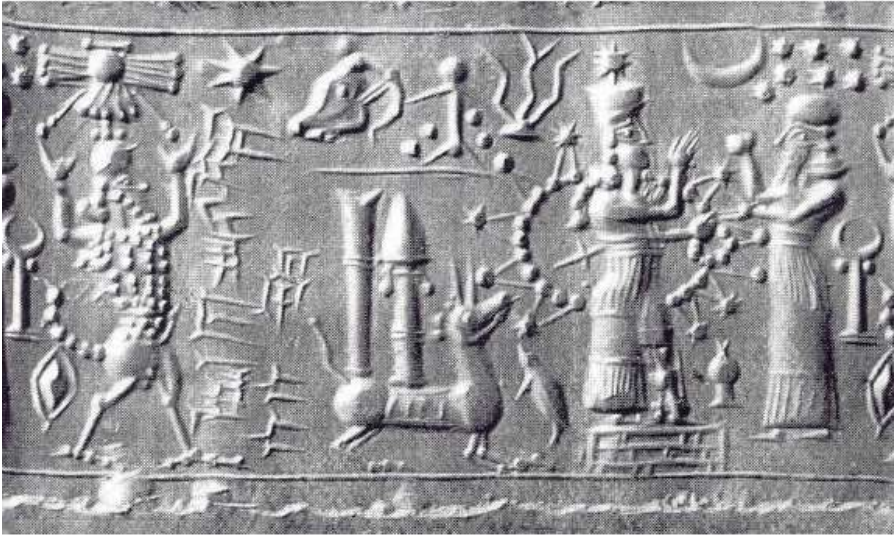

Heiser: the 7 blobs at the top right of this Sumerian image represent stars of the Pleiades. Heiser therefore argues that in VA243, the Sumerians are showing stars in another constellation, around a brighter star, “not planets around our sun.” Heiser does not identify which constellation these stars are from, however, stating:

There is therefore abundant precedent for asserting that these dots in VA243 are stars. It could be that this seal is “saying”: “Constellation = the one with 11 stars”. Since I don’t know astronomy well, I’ll let the reader ponder that one.

Whilst I take Heiser’s point about the consistent way the sun is represented in these works, he is not able to positively identify what the “big” star symbol with the smaller stars around it is. Perhaps both Sitchin and Heiser are wrong and it represents some other celestial object...

Heiser’s criticisms of Sitchin are therefore fairly specific and limited, mainly relating to translations of specific words and interpretations of 2 or 3 images. Heiser doesn’t, for example, go into the level of detail I have in this chapter. We should also note that [Heiser is a Christian though, so his beliefs may affect his objectivity in some areas of this matter.](#)⁵⁵³ That is to say, that many Christians find the idea or suggestion that “aliens created human beings” too challenging to their faith. Similarly, mainstream scientists also find this idea challenging to their beliefs.

Who was Sitchin?

In the 1993 interview referenced earlier in this chapter, Sitchin stated

All the information, all the sources that I am giving, are academically, scientifically, scholarly known and accepted sources. At no time do I invent my own source.

Why does Sitchin say this? It sounds a bit like a “need to convince us of his sincerity.” We have repeatedly observed that though Sitchin’s sources may be real, he doesn’t always say which source he is quoting, and his interpretation of that source is not always fully explained – or even correct.

Should we also ignore Sitchin’s connection with Israel, and that he has certain establishment connections?⁵⁵⁴ We can also note that almost a decade before the publication of “Twelfth Planet,” the Sumerian Cylinder Seals were mentioned on page 456 of the Sagan-Shklovsky 1966 book “Intelligent Life in the Universe,”⁵⁰⁶ as I quoted earlier.



Some argue that Sitchin is misleading us regarding Nibiru and the other “11 planets.” A few years ago, a YouTube video surfaced claiming to show Sitchin dressed in full masonic regalia. It does look a lot like him...⁵⁵⁵ A still from this video is shown on the left. Why is this person attempting to cover his face? (Several people in the video do the same).

Sitchin’s Information and Disinformation

Based on a review of “Twelfth Planet” and the timing of its release (when interest in the “Space Race” and Science fiction was increasing), I think that Sitchin was knowingly promoting some disinformation. I think that the stories he tells about Nibiru are false, as are related stories to do with the history of the solar system. Also, the very existence of a Twelfth Planet, of the nature he proposes, is highly questionable and yet has become a powerful cult phenomenon in the online “conspiracy community.” If Planet X cannot exist, then the stories of the Anunnaki coming from Nibiru cannot be true either. Sitchin is primarily associated with stories of Nibiru and Planet X, in its various forms and functions. In chapter 21 of my book “Secrets in the Solar System,”⁵⁵⁶ I discussed that Sitchin’s proposed orbit of Nibiru would not be stable and I discussed other problems with the proposed “Planet X” theory. Further, I noted in chapter 14 how Sitchin included incorrect information about Phobos in his “Genesis Revisited” book.

Sitchin’s work is often lambasted or ridiculed because of the obvious lack of a Planet X. However, we should beware of “throwing the baby out with the bath water,” because the other area that Sitchin talks about is human evolution – a topic he is much less frequently associated with, generally, than “aliens from Planet X.”

I do think that there is valuable information and thinking and analysis in Sitchin’s work. His work, and that of Lloyd Pye highlights the importance of early Sumerian/Babylonian creation stories, such as Enuma Elish and the Epic of Gilgamesh – which, in my experience, few westerners have heard of. The information about the general nature of Sumerian civilisation, its

development and Sitchin's discussion of the development of agriculture seem to be fairly accurate.

Also important is discussion/presentation of the idea that humans were genetically engineered by another race...

Early Civilisation and Intervention Theory

So, whilst being critical of some of Sitchin's work, I should also note that there is strong agreement that the Sumerian civilisation and culture had no precursors. The question then remains - where did this civilisation come from? Why do we even have stories of gods and superior beings? Many people still base daily activities on aspects of these stories? Why aren't all our legends just concerned with roaming the planes and interacting with animals and nature? Could it be true that a race of beings did land here and "intermingle" with humanoids here and make them "civilised"?

Lloyd Pye was the first to bring to my attention the enormous problems that Darwinian evolution has in explaining the appearance of *Homo Sapiens*.⁵²⁴ It is claimed in mainstream theory that chimps are our closest living relatives, yet they have 48 chromosomes and humans have 46. Lloyd Pye always stated that he thought 2 chromosomes had been fused to together in humans (i.e. with 24 chromosomes in chimps from each sex, if 2 were fused together, it would make 23 chromosomes in one sex.)⁵⁵⁷ Pye also noted the dissimilarity between Chimps and humans – such as them being about ten times stronger, for a given body weight, than humans are. We will explore this area more in the next section, where we take some of Sitchin's ideas and "combine" them with what was covered in Robert Temple's "Sirius Mystery," and a lesser-known theory relating to human origin. This will still relate, however, to the idea that off-world beings genetically engineered humans.

The Dogon and the Aquatic Ape

In chapter 18, we learned about the mythology of the Dogon tribe and how the Nommo (a race of Fish people) came to earth and gave us civilisation. Also mentioned in Temple's book are the stories we have in Western Culture of mermaids/sirens – fish people. Not mentioned in Temple's book is the "Aquatic Ape" theory, which was promoted, initially, by Elaine Morgan (1920 – 2013) in the 1970s⁵⁵⁸. Morgan had come across the theory, which was mentioned in Desmond Morris' 1967 book "The Naked Ape"⁵⁵⁹. This theory considers that humans have a number of characteristics that are found in marine mammals but not in any primates. Morgan wrote on her website⁵⁶⁰:

In 1960, Professor Alister Hardy published his idea that several of these differences would be much easier to explain if our ancestors had lived not on the open grasslands but at the water's edge.

Morgan wrote about this in her book "The Descent of Woman," which was published in 1972 and it became a best-seller. Of this book she writes:⁵⁶¹

The Descent of Woman became a popular best-seller, but the scientific community, naturally enough, reacted with contempt. They had strong reasons for doing so. I had no scientific qualifications, the book was politically motivated, the style was confrontational and I wrote it too fast to have done much research. Moreover, the concept of the ape that moved to the plains had been unquestioned for over forty years.

I must mention here that Morgan had no obvious interest in aliens, Sitchin, UFOs or any of these topics, she merely became interested in the idea that humans had some connection to aquatic mammals. [She explained this more in a 2009 “TED” talk](#)⁵⁶².

We will now examine compelling evidence which suggests this theory is correct. [A website called “Primitivism.com” carries an excellent summary of this evidence, which is easy to describe and understand.](#)⁵⁶³

If we compare humans to mammals which spend the majority of their time in water, we see some very interesting common characteristics, which we do not share with chimpanzees or any other primates.

The first one is that humans have a layer of fat – called subcutaneous fat and can they can become very obese. [We are the only primate that has this.](#)⁵⁶⁴ We have “naked skin” - like a Hippopotamus or an Elephant. We actually have most of our hair in the opposite places that a chimpanzee does. Consider Walruses and their apparent obesity and why they are like that. Also consider Seals and Dolphins.

We are the only bipeds in the animal kingdom – and apes / monkeys are forced to become bipeds when wading through water (and this is when they will spend the most time walking on two legs.)

Human speech requires conscious control of breathing – which is also required in diving animals and birds. When, for example dogs or chimpanzees are swimming or wading up to their necks, they will always keep their head above water. [The website article by Elaine Morgan, referenced above](#)⁵⁶³ notes:

Humans have millions of sebaceous glands which exude oil over the head, face and torso, and in young adults [this] often causes acne. The chimpanzee’s sebaceous glands are described as “vestigial” whereas ours are described as “enormous”. Their purpose is obscure. In other animals the only known function of sebum is that of waterproofing the skin or the fur.

Morgan then observes:

The most widely discussed contrast between ourselves and the apes is that we have bigger brains. A bigger brain may well have been an advantage to early man, but it would have been equally of advantage to a chimpanzee: the question is why one of them acquired it.

One factor may have been nutritional. The building of brain tissue, unlike other body tissues, is dependent on an adequate supply of Omega-3 fatty acids, which are abundant in the marine food chain but relatively scarce in the land food chain.

Also, in this same article, Morgan includes a table, comparing certain characteristics of Humans with Apes, Savannah dwellers and Aquatic

Mammals. I have included a slightly modified version of this table below (additions shown in parentheses).

Characteristics	Humans	Apes	Savannah	Aquatic Mammals
Habitual Bipedalism	Yes	-	-	-
Loss of body hair	Yes	-	Yes	Yes
Skin-bonded fat deposits	Yes	-	-	Yes
Ventro-ventral copulation	Yes	Yes	-	Yes
Eccrine thermoregulation (Ability to sweat)	Yes	-	-	Yes
Diminution (reduction in size) of apocrine (sweat) glands	Yes	-	-	Yes
Hymen (Vaginal membrane)	Yes	-	-	Yes
Enlarged sebaceous glands	Yes	-	-	Yes
Psychic tears	Yes	-	-	Yes
Loss of vibrissae (whiskers)	Yes	-	-	Yes
Volitional breath control	Yes	-	-	Yes
Descended larynx	Yes	-	-	Yes

Morgan then notes:

The ‘Yes’ in column 3 refers to the bonobo; in column 4 the rhinoceros and the elephant.

Further to this table, we can mention articles which note “[Dolphin DNA Very Close to Human](#)”⁵⁶⁵ and “[Diving Deep into the Dolphin Genome Could Benefit Human Health](#)”⁵⁶⁶.” A paper on PubMed with a title “[Morphological evidence of marine adaptations in human kidneys](#)”⁵⁶⁷ notes similarities between human kidneys and those of marine mammals. [This is also quoted on another website in an article about the kidneys.](#)⁵⁶⁸

Aquatic Apes – Scepticism

Sceptics would, of course, try to protect their reductionist world view by pointing out the numerous dissimilar characteristics between humans and aquatic mammals (though they would not do this in relation to the comparison between chimpanzees, gorillas and other monkeys and apes).

Indeed, we can see this sort of activity on [a website compiled by Jim Moore](#)⁵⁶⁹ who does seem to be a biologist, zoologist or be qualified in a closely related science (his biography isn’t clearly displayed on his website and his choice of domain name is also interesting). He ridicules, in particular, Elaine Morgan and had, apparently, been doing so for many years. [Morgan responded thus](#)⁵⁷⁰:

Jim Moore believes that the aquatic theory is bunk, and his on-line dossier denouncing it has been growing ever thicker over the decades. Since his site is www.aquaticape.org, many people looking online for information on the subject come across his views before they have heard the arguments in favour of the theory. He is ready to attack anyone who speaks out in support of it, but I am his favourite target, and I have been urged to respond.

One problem is that my books are in print and he can give references to them, but his website statements are subject to regular revisions, amendments, and additions.

Is Jim Moore sincerely interested in the truth? I'll leave readers to review the evidence for themselves.

The Hybrid Human and Domestication of Animals

“The Hybrid Hypothesis - Human origins: Are we hybrids?” is the title of an article by Eugene M. McCarthy, PhD. McCarthy, like others, has observed certain human characteristics which are unique among primates and he includes a comprehensive list (but using technical terminology) in the article, referenced below. [This genetics researcher, who worked at the University of Georgia between 1989 and 2007⁵⁷¹](#), starts by pointing out that is untrue to state that all hybrid animals, like the mule (a cross between a horse and a donkey) are sterile.⁵⁷² He notes the many hybrids (e.g. many birds) that are fertile, although with reduced fertility compared to non-hybrids. McCarthy then notes that humans are less fertile than other mammals and that human sperm is “abnormal in comparison with that of the typical mammal” and “not of one uniform type, as in the vast majority of all other types of animals.” He also notes that “a high percentage of human spermatozoa are actually dysfunctional.”

[McCarthy also shows that some distant crosses \(hybrids\) have been successful in one type of species – Pisces – fish!⁵⁷³](#) The main thrust of McCarthy’s hypothesis is that humans may be the result of a cross between pigs and chimpanzees – and he argues this case based on the list of about 80 characteristics that both pigs and humans (but not chimpanzees) have. Of course, he is regarded as something of a “maverick” thinker – despite the obvious evidence that he highlights. McCarthy, as far as I know, does not consider the origin of the “human characteristics” of pigs, however.

Now, we can consider the origin of the “modern pig” – along with other domesticated animals – such as cows and sheep. It is assumed that pigs are the domesticated descendants of wild boar and, according to an article titled [“How did the wild boar become the sweet domestic pig?”](#) by [K. Kris Hirst⁵⁷⁴](#), they came from southwest Asia where:

*...pigs were part of a suite of plants and animals that were developed in the upper reaches of the **Euphrates river** about 10,000 years ago. The earliest domestic pigs in Anatolia are found in the same sites as domestic cattle, in what is today **southwestern Turkey, about 7500 calendar years BC (cal BC)**, during the late Early Pre-Pottery Neolithic B period.*

How sensible is it to suggest that the Anunnaki mixed some of their DNA with several species, not just hominids to create “domesticated humans” as well as domesticated cattle, sheep and pigs? [Were Cheetahs created by the Anunnaki as a hunting animal \(as Lloyd Pye suggested\), by genetically crossing a cat and a dog?⁵⁷⁵](#) (This would explain why Cheetahs⁵⁷⁶ – all virtual clones of one another⁵⁷⁷ - are susceptible to both dog and cat diseases, have the head of

a cat but the paws and body of a dog – and many other unusual characteristics.)

Summary and Conclusion

In Sitchin's first work, he doesn't give much of a physical description of the Anunnaki, other than it is suggested they are "giants" and of general human/humanoid form. (But I don't believe they came from Nibiru and neither is Nibiru part of our solar system.)

If we accept that Sirius is an important focus of Egyptian history and rituals, then we can try and "factor in" the Dogon and the Nommo, might I suggest that the Anunnaki actually had some connection to the Nommo? Did the aquatic characteristics of human physiology come via the Anunnaki from the Nommo, or were the Anunnaki somehow involved with the visitation by the Nommo? Was Anunnaki DNA used to create other hybrid animals, described in various mythologies – not just humans – but pigs, cows and sheep? Is this what has been covered up or lost in ancient history – or am I just making too many wild guesses?

Humans did not evolve from apes or any other "primate." The genetics do not support this conclusion and neither does the time scale. I agree with Pye and others that suggest that new species of plants and animals are probably "brought here," when the environment can support them. I agree with Lloyd Pye and Zechariah Sitchin that humans were created through a process of genetic engineering.

Many of the myths in the world allude to the creation of humans by one or more "gods" and I myself have no problem with the idea that these gods were, indeed, "ancient astronauts" or "aliens" or "off-worlders," who were participating in the "management of the development of life in the cosmos," just as humans now try to manage and develop life in many terrestrial environments. As many others have pointed out, humans have also been doing their own experiments in genetic engineering for a few decades now.

20. Alien Races...? Alien Faces...?

Alien Races?

A few years ago, I was having an e-mail exchange with someone, during which the work of a researcher and author [Laura Knight Jadczyk](#)⁵⁷⁸ (LKJ) came up. I was reminded of [her discussion of the role of “Cassiopeians” in the history of the Earth.](#)⁵⁷⁹ I have not read her book about this, so I do not know all the details, but on her website, it is stated that she “channelled” information. This seems to bear a strong similarity to other channelled information, as the Website itself states:

There have been other pretty good sources of channeled material with a relatively high level of accuracy, such as the Ra entity in the Law of One books and also the sources of Bringers of the Dawn channeled by Barbara Marciniak. They may not be on the same level of accuracy and clarity as the Cassiopaeian material, but they DO contain a considerable amount of accurate and useful information that is largely in agreement with the Cassiopaeian transmissions.

(I have not studied this material, because I started to read LKJ’s [“9/11 Ultimate Truth”](#) book - co-authored with Joe Quinn and first published in 2007⁵⁸⁰. I gave up when I found the errors in the book were too great for me to continue. Additionally LKJ apparently puts [insults before evidence in relation to 9/11 research on her own website](#) stating⁵⁸¹:

Ya’ll just LISTEN to this nutcase, Judy Wood. The woman is certifiable, if you ask me. Not saying her ideas are wrong, but she discredits her own work by her manner and her “fan-bots”.

I know I have digressed here, but LKJ’s quote shows how seemingly intelligent people can accept and disseminate channelled information but in “the next breath,” ignore voluminous physical evidence relating to a world-changing event that happened, on earth, in broad daylight in 2001.)

However, this talk of Cassiopeans made me think of how many different ET groups people have claimed to be in contact with or have some knowledge of. The purpose of this chapter is merely to gather some of these references and not really judge them “one way or the other.” They are included below with a short description. Sometimes these alleged aliens tell contactees where they originate from, sometimes they don’t.

There are billions of places in the Milky Way that we cannot see. How many more places are there that are outside our galaxy? And if aliens were to tell contactees where they are from, would those contactees know, say, [the Messier Catalogue](#)⁵⁸² or [the NGC](#)⁵⁸³, off by heart? And why should ET’s be from a place we have named in the sky?

In what I consider to be some of the most compelling accounts (that I have come across and covered in this book so far) – such as those of Travis Walton, Wilbert Smith and Sixto Paz Wells – where it seems clear that ET’s are involved, the same ET’s don’t say where they are from.

In the case of the Dogon tribe, where they *do say* where the ET's are from, it turns out that we can't see the star they talk about the most.

Different sources give conflicting information about the number of alien races that have either visited the earth or are visiting the earth. For example, [Clifford Stone stated at the Disclosure Project Press Conference in 2001 that he had been told there were 57 races that were known about.](#)⁵⁸⁴ However, because Stone did not actually state that he would swear an oath that he was telling the truth, I don't think he was being totally honest about what he knew. It was probably just another story he was repeating.

Other places that have been mentioned as the homes of alien races are listed below (but I haven't included complete references here – as some of these we have already covered and the rest, well, you can use your favourite search engine!)

- The Pleadians/Plejarans (Billy Meyer)
- The Orions (Credo Mutwa and others. [Mutwa is almost certainly involved in some disinformation operations, however](#)⁵⁸⁵)
- The Andromedans (Alex Collier – see below)
- Dracos/Alpha Draconids (written about by Michael Tsarion)
- The Zeta Reticulans or Zetas (Betty and Barney Hill Abduction case)
- Ultra-terrestrials - Sixto Paz Wells
- The Galactic Federation of Light (Sheldon Nidal, Blossom Goodchild and others).
- Reptilians (David Icke, John Rhodes and others)
- Anunnaki (Zechariah Sitchin)
- The Greys (Whitley Streiber and many, many others)
- The Venusians - George Adamski

In all cases, there is no way we can verify where these beings are from or what their real plans or motives are. Though certain common themes occur (which we explored, to some degree, in earlier chapters), information conflicts. We have a bewildering array of information to examine - and here, the task of “sifting and sorting” is seemingly much harder than with other topics because, by definition, the study of this sort of material stretches our human understanding to its limits.

In general, when predictions have been made in alleged communications with these aliens, they have mostly been wrong.

The most relevant statement that I have heard in relation to this is one given by [Alex Collier in an interview in 1994](#)⁵⁸⁶, when he stated the ET's, who were trying to help us, mentioned a cut-off date of “August 2001.” Of course, this could just be a “lucky guess” in relation to events that were about 7 years in the future when his interview was recorded. Collier also mentioned Phobos, which I wrote a whole chapter about in the [“Secrets in the Solar System:](#)

[Gatekeepers on Earth](#)¹²⁴⁷ book. He is an interesting and passionate speaker, who *didn't* or *doesn't* have a calm demeanour. Nevertheless, there is something about him – and what he says that, for me, makes his statements harder to dismiss as paranoid fantasy.

Lyrucus and “The Sovereign Integral”

The [Lyrucus Teaching Order](#)⁵⁸⁷ has written some of the most interesting material I have seen - about the nature of our being. This site is rarely discussed, and neither is the associated site, [Wingmakers](#)⁵⁸⁸. (Some claim these sites are simply a hoax.) My opinion of this site has not changed since I was shown it in about 2004 or 2005. It doesn't seem to have any “strings attached” to it – you are not encouraged to believe it or disbelieve it – it is presented in a neutral manner. [Here is a small sample of the material they have posted](#)⁵⁸⁹:

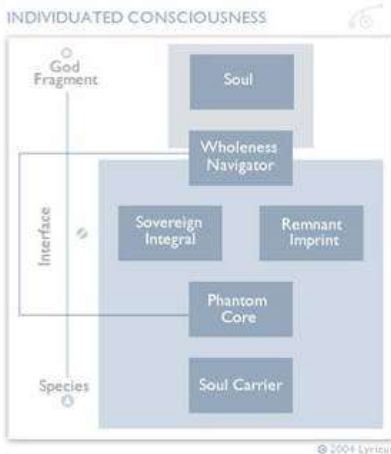

QUESTION 5: *What is the definition of the soul?*

ANSWER 5: *The soul is literally a God Fragment that is composed of a hierarchy of capabilities and functionality that permit it to be simultaneously individuated and whole. As it enters the soul carrier at or near the physical birth, it begins to form a matrix of interaction with the soul carrier – testing the vibrational resistance of the soul carrier, as well as its zones of resonance. It is encoded in the soul carrier template that hearing, at least initially, is the most developed of the senses*

through which the soul can perceive the physical domain. Eventually, the eye-brain system emerges as the dominant portal of perception. The physical world of dimension and time creates the separation of the world of soul and the world of the soul carrier. Because soul is a God Fragment, and the soul carrier is a representative outgrowth of both the species' evolutionary trajectory and the original designs of the soul carrier template, they are fundamentally incompatible. Thus, the Central Race engineered an interface that serves to integrate the soul and soul carrier, and orient the collective known as the individuated consciousness.

I've not read anything similar to this anywhere else and, perhaps it is a description that just appeals to my “engineer's mind,” but the description above seems to have been written by someone who “really knows their stuff!”

Wingmakers – Music, Art and Being



Thought by some to be an “Elaborate Marketing Scheme”, [the Wingmakers site](#)⁵⁹⁰ offers some detailed information and distinctive and provocative graphics and music. It is associated with the “Lyricus” site, mentioned above. It talks about a “mythology” and “a central race” who are here to help us discover the “grand portal” – of consciousness. It is a complex and detailed site – containing thousands of pages (and therefore dissimilar to other sites which just want to make money or start a “pyramid” scheme).

Personally, I think, the skill of presentation of the material, and the depth and eloquence

therein is “a level beyond” what I have seen elsewhere... There is definitely something unusual about this site, which makes me feel it is worthy of further investigation.

Alien Faces?

In 1996, [an artist called David Chace](#)⁵⁹¹ published a book of artwork he created, based on the stories and descriptions given to him by various [contactees and abductees](#).⁵⁹² It makes for interesting viewing, and includes quite a few images of creatures seemingly not depicted anywhere else – even in Science Fiction and Science Fantasy artwork. Could we say that these are accurate portrayals? Are there any other photos or videos we can look at which we can confidently say actually show an alien face or body? I would say that the short answer to that is “not for certain.” However, for those that haven’t looked in to this area, I would also say there are some very interesting photos of aliens. Investigation of the “back story” and provenance of some of these images suggests they are authentic.

[UK researcher and barrister Isaac Koi](#) has collected together a fair number of these photos and tried to find the story behind each.⁵⁹³ It becomes clear that a fair number of the photos are of models or dummies created for Science Fiction films and then they have been photographed and photoshopped into other images (e.g. one showing Adolf Hitler shaking hands with an alien). Looking at Koi’s site, however, gives the impression that all the images and videos have been explained or “debunked.” This is a shame really for, as we will now cover, there is more than one interesting “alien photo” which may actually show “a real thing.” Here will look at several cases I could *not* find on Isaac Koi’s website.

Filiberto Caponi's 1993 Close Encounters

This case was written about extensively by UK researcher and author [Timothy Good](#) – in his book “[Unearthly Disclosure](#).”⁵⁹⁴ [Patrick Gross](#) has an excellent set of pages about the case.⁵⁹⁵ On the evening of 9 May 1993, Filiberto Caponi, a sculptor and ceramicist, had come back from riding his motorbike in Abruzzo, Italy and he was putting it back in the garage. Hearing a noise, which he thought might be an abandoned cat, he saw some type of creature which seemed to have been trapped in a bag.



He reached out to touch it, but thinking he might be scratched, he poked at the thing with his foot. The very unusual thing about this was that the “thing” returned on August 11th, (when he managed to take two polaroid photographs of it). It returned again on August 20th and finally on Sept 20th and on each



Technology so advanced it will help answer some big questions.

THORNE® Advanced Composites
Thorne® multi-axis reinforcement. Our fiberglass pultruded fibers based on our technology patented worldwide, are now available in a new form that are including pultruded prepreg pipe of low moisture. These materials and moisture resistant properties essential for solving many of your most demanding problems when it comes to pipe, water and deep space applications.

See performance benefits. So far, this new technology has shown effective characteristics for superior to current materials. It also reports enhanced dimensional stability allowing you to tailor coefficients of expansion (CET) or negative Poisson's Ratio, with thermal conductivity 3 to 5 times that of copper. A true alternative of thermal management problems encountered in aerospace design.

The advanced composites. While current applications include laser, fiber optic, low dielectric technology and use in space radiators, space probes and test cells, the potential of this material can take you far beyond today's design limits. With our ongoing research and the evolution of design the evolution of space will become revealed.

We can help. Ask us questions. Our research people can guide you to material solutions for your toughest design problems. You can reach us at Amoco Performance Products, Customer Service, Lawrenceville, GA (770) 888-9999.

We do more than create the technology. We share the vision.



Amoco Performance Products

(A slightly clearer version is shown below).⁵⁹⁸ This image appeared around the time that the Bob Lazar story first came out and people had begun to talk about Area 51. The image in question appeared on page 51 of the magazine (according to Norio Hayakawa)⁵⁹⁹. It's easy to ignore this image as just a model and/or a marketing gimmick, but Cooper said he investigated it and didn't get "straight answers" where one would have expected them. Cooper stated that in an enlarged version of the photograph, small hairs can be seen on the neck. This caused him to try and track down the photographer so that he could ask them what they photographed. The photographer apparently couldn't tell them what he was working with, but he did send them an 8" x 10" print of the negative. Cooper spoke to someone at Amoco:

First, they told us that it was a nine-foot-tall bronze statue. Second, they told us it was a 12-foot tall bronze statue and third they told us it was a 9-inch clay statue. When we pressed for more information and [we] became literally obnoxious on the phone, not accepting what they were telling us and wanting to see the original artwork, they refused and hung up on us.

As well as the hair, Cooper noted that the skin had very fine detail in the dimly lit parts. He also noted there was the appearance of moisture in the eye and in the nostrils. The lips also looked real to him, as well as bags under the eyes and the appearance of the eyelids. As Cooper said in his presentation, we cannot say for sure that this is a picture of a real, live alien. However, I would not be at all surprised if it was – one of the aliens that have been in captivity since whenever it landed, crashed or was shot down here.



The Alien Interview – 1997



Alien and Medic



Victor

There is more than one alleged alien interview that has appeared on the internet – though none have both audio and video of the alleged alien. The video we will discuss in this section, now over 20 years old as I write this, first came to light in [March and May 1997](#) when an [anonymous whistle-blower](#) called “Victor” was interviewed on Art Bell’s “Coast to Coast” Show⁶⁰⁰. He claimed to have smuggled out a video of a living alien being interviewed at the S4 Lab in Area 51. Above is a still from this video. It was in July 1996 that “Victor” approached a production company called “Rocket Pictures” where Tom Coleman, the president of the company, who was initially sceptical of “Victor,” decided to listen. He initially declined the approach, but then reconsidered the matter, because Victor seemed to be serious-minded. Victor encouraged Coleman to do any checks or tests and “due diligence” on the tape that he wanted to do, but Victor said he must remain anonymous.

Coleman interviewed Victor on camera, but he was heavily disguised and when he appeared in the documentary, his voice was altered.⁶⁰¹ Victor stated in the interview he had copied the tape during an archiving / media transfer process. He removed the soundtrack to reduce the chances of other personnel seen in the video being identified. He also stated he had actually seen the alien that appears in the video, though he was not involved in the interview. Victor stated that the interview was fairly recent (i.e. was done in perhaps 1995 or 1996). He stated the being had arrived in Area 51 in 1989 and that the being was interviewed twice per month for 3-5 hours. Victor stated that the being had revealed some minor technical details about “how the saucers operate.” He also stated that physicists were frustrated because they couldn’t decide whether the being was withholding information, or whether the problem was that the information that was coming to them through a telepath and it was too complex or advanced to be “fitted into our limited conceptual framework.” Victor also stated he thought the being “had a much easier time communicating spiritual concepts.” However, Victor also implied he didn’t necessarily believe that the beings had our best interests at heart, just because they were much more intellectually advanced than we are. He said he was releasing the tape to “expose the existence of the aliens.”

Victor gave a commentary on the taped interview, which is about 2 minutes and 50 seconds in length. He said the interview took place in an “interview suite” at S4 (in Area 51) which is “kept dark for the comfort of the aliens.” He reports “the telepath” is a barely-visible figure in the left foreground and behind the camera is a red-seating area for observers. He stated the only other person present when this particular interview was filmed was a military aide. He said the alien is seated behind a glass panel in a bio-containment area – but this is more for the protection of the aliens than us, as they eliminated infectious bacteria and viruses from their ecosystem a long time ago. Victor said, however, they can be affected by terrestrial bacteria in their respiratory systems and this means they are “more debilitated” in our environment.

In the interview, the alien is seen to bend forward, with respiratory difficulties. He states the telepath sends a message to the medics, but the response is slow. Victor also states that medical staff are “selected for their willingness to keep secrets rather than their medical competence.” The medic is seen shining a torch into the alien’s face and Victor reports that this is to “check for haemorrhaging” (bleeding) around the eyes and nasal cavity. The medics are seen to wipe around the mouth of the alien. Victor reports he is uncomfortable watching this. He states he does not know if the alien later died, but he knew the interviews came to an end and he explained the beings don’t seem to be concerned about dying. Victor speculated that they might know “what comes after death with more confidence than we do.” Victor then speculates that the beings may actually not be from another star or galaxy at all - their ships may “fold in” from another dimension – and it is to this dimension that they return when they “die.” He states that the beings are regarded by some as angels or devils (a common comparison – particularly

among those who resort to a religious paradigm to explain away the “aliens” reality) .

Evaluating the Video

There are many interesting aspects to this video which lead me to conclude it is “the real deal.” I will discuss these below.

The tape does indeed look like a recorded interview – nothing much really happens. The events as described by Victor match the scenario. Victor himself is clearly very intelligent and very articulate. He seems to realise that most people aren’t bothered enough about the truth to deeply consider the truth and evidence he has released. The eyes and the movement of the alien seem real to me – and if these were to be faked, it is quite a “boring” thing to fake (an alien coughing and adopting a stooped expression). In the reports of humans encountering grey aliens, it seems the majority of the accounts that are given are not in daylight – they are at night or in a low-lit room. A heart monitor blip is seen in the lower right of the image (just above the colon in the image above) and this moves realistically. The movement of the mouth – from closed to open also seems real. The way that the medics come in and inspect the creature’s condition does not seem unrealistic to me. If a puppet or dummy was being used, then shining a bright light onto the model would be more likely to reveal it as a fake.

The stamp on the video “DNI” is also interesting – some have suggested this ties it to the “Department of Naval Intelligence.” Others have claimed this proves the video is disinformation because there is no such organisation – the closest in existence is [the “Office of Naval Intelligence.”](#)⁶⁰² Of course, the meaning of the video’s label is speculation – the initials could relate to the code name of the black programme that the video is part of, or it may refer to the interview room or the initials of the interviewer. Victor was apparently not asked about what this “stamp” was for.

The “Rocket Pictures” 1997 one-hour video “Alien Interview” in which Victor’s video was presented, also includes a short dramatic reconstruction of part of the Alien interview – where there is a discussion about human bodies being “vessels” or “soul carriers.” So, it appears Victor – or someone else – must have given them a few more details about what was actually gleaned in some of these interviews.

An interesting possibility is also raised in the documentary by UFO researcher Michael Hesseman – he suggested a link to the alleged shoot-down of a UFO in the Kalahari Desert in 1989 – an incident which involved the South African Air Force. Allegedly, two beings survived the attack and one was sent to Wright Patterson Air Force Base (Ohio) and the other was sent to Area 51. Allegedly, the beings’ description matched those (allegedly) given by witnesses to the Kalahari event. (The Kalahari event is covered in some detail in [Tony Dodd’s “Alien Investigator” book](#)³.)

Evaluating Victor

During the 1997 video, Victor was asked “If the government has really been in contact with superior aliens wouldn’t, we see some evidence of it, for instance, amazing new scientific discoveries?” He replied:

Limitless free energy? A cure for cancer? We might if the government's motive for the betterment of mankind. The government's motive is control and just as much as they crave control, they fear loss of control. Knowledge is power, but power does not necessarily confer competence. The people at the top of this program are intellectually very average. They're not capable of making proper use of what's been handed to them, but they have no intention of letting anyone else ever get a chance to solve the puzzle. And let's not forget, there's also the real possibility that the government is being manipulated by the extraterrestrials for their own purposes.

This is exactly the same type of thought process I have gone through – and I ask the same sort of question and have the same observation. Victor was also asked why he demanded to be paid for releasing the tape and the effect this demand had on his credibility. He replied:

That's a cross I'm prepared to bear. I find it disgusting that the most important event in human history is being kept secret simply because certain unimaginative officials have the power to do so, but at the same time I do see the irony in my own actions. All I can say is, had I had the choice, I would not have insisted on profiting from this revelation. But since by lifting this veil I've endangered not only my career, but possibly my life I felt the need for some small measure of monetary freedom to deal with any eventualities. And let me say I could have demanded significantly more money than I did, if I had been willing to compromise my anonymity.

He also talked about threats to his life and said that he hoped the government would not attempt to kill him, but he didn’t want to “give them the chance to prove him wrong.” He then said he was “counting on being disbelieved.” He is asked why anyone should believe the tape showed a real event. He responded:

Use your own judgment - that's all any of us can do. There's been so much secrecy and disinformation over the last 50 years that it's become impossible to prove anything in the face of official denial. Of course, the flipside is nobody really believes anything the government says.

The Return of Victor

In 2008, Victor “re-appeared”⁶⁰³ – still anonymous and in disguise and a new interview with him, which took place in a car, was included on a [DVD of an “Extended Edition” of the Alien Interview](#)⁶⁰⁴. There was little new information in the video and Victor was clearly frustrated that no one really tried to verify the alien interview video (or him), in a more extensive way – for example by trying to prove it was a hoax – by finding the model or puppet maker who had made the “fake alien” in his video. He criticised the UFO/ET research community for the lack of real investigation – for example using FOIA’s. He repeated that the video was not a joke or a hoax.

He implied he was targeted soon after the video was released, and his career ended – though he had remained in contact with others who were dealing with information gleaned from the aliens. He was asked about the present location of the EBEs (aliens) and whether they were still at a base in Utah. He replied that the EBEs were all “deceased” as far as he knew.

He was asked about Cheney and Rumsfeld (Bush’s secretary of Defence) and his knowledge of the UFO / Alien / EBE issue (the second “Victor” interview would have taken place soon after the end of the George W Bush administration.)

Certainly, Cheney knows everything there is to know within the government. There’s not much that is kept secret [from him] ... Rumsfeld is a bombastic clown, but he has certainly shown quite a bit of interest in new technologies, shall we say. I will say this to those UFO researchers who seem to be sitting on their hands waiting for someone else to bring them information. If you are being a researcher and discover where one of them was in the middle of March of this year, I think you will learn a few things that perhaps you’d like to know.

Victor and Donald Rumsfeld

He expands on the Rumsfeld issue later in the interview:

Donald Rumsfeld has been aware of the alien interviews at least since 1974 in the last days of the Nixon Cabal and even when he was out of government, he managed to keep his hand in but it was not until the bogus telepath program was finally exposed within the secret black-ops operation, that the true translation, that the true meaning of the alien communication was made clear to him. And since then, I think you will find he has lost all interest in the United States - and trivial earthly power. His sole interest now is to find a way to be one of those who are “taken off” when the end comes...

...Donald Rumsfeld is merely one of the last of the line of those who try to maintain personal control over information that should have been made public - to the entire human race and now that he understands exactly what it is these aliens have been trying to tell us, he has completely lost interest in the rest of humanity. His sole concern is to be one of the few - that he considers to be the elite - the elect specimens – who are taken off the earth before the final trumpet sound.

While on the subject of Donald Rumsfeld, we can mention what was said about him by Dr J Allen Hynek, who apparently got to know Rumsfeld in the 1970s, when Rumsfeld was Secretary of Defense under Gerald Ford. On 10 November 2003, [Budd Hopkins stated on a Rense Radio Interview that Hynek had got a strong reaction from Rumsfeld when he brought up the UFO/ET issue](#)⁶⁰⁵:

Hynek, who had worked as a UFO expert/consultant for the Air Force, had gone to Washington and got an appointment with Rumsfeld. After some Small talk, in Rumsfeld’s office, Hynek turned to Rumsfeld and said

“Don, I have to ask you something. I have been in this for years looking at the UFO phenomena. I feel like at this point in my life I am in a position of ‘need to know’ what you know or what some agency might know that I don’t know. I have a ‘need to know’ I feel.”

According to Hopkins' description of the meeting, Hynek said that Rumsfeld stood up and pointed a finger at him and said, "You have no need to know" and then Rumsfeld sat down again. That was the end of the conversation. Hopkins reported that on further discussion with Hynek, he couldn't decide whether Rumsfeld "knew stuff" that Hynek didn't know, or that Rumsfeld wanted to know more, but it had been kept secret from him too.

Victor, Bush and the End of the World?

Returning to "Victor's" interview, in relation to the Bush administration, he described how he thought President Bush was a puppet and was "irrelevant" to decisions made in Government. He was asked about 9/11 but refused to talk about it saying it was like "The Bermuda Triangle."

He also stated that from the information got from the aliens, he thought the "end of the world" was approaching:

Let's just say that I wouldn't plan on a 20th anniversary edition of this documentary.

He implied the aliens would have something to do with our demise saying, "the aliens had presented themselves as a test to humanity, and we had been found wanting." Victor implied that he was in poor health and near the end of his life.

Here we have the "end of the world" theme being repeated – in a similar way to what some abductees have reported – that humans will be the cause of "Armageddon" – and that they have failed some type of test. Was Victor fed disinformation in this regard? Here we are, 11 years after his prediction – where nothing seems to have changed.

Video Analysis by "Victor Nevada" aka Andrew Burlington

Perhaps in response to "Victor's" challenge to people to study the video properly, in 2014, UFO researcher and experimenter Andrew Burlington created a YouTube channel devoted to close analysis of the Alien Interview. He was originally sceptical about the video's authenticity so performed a frame-by-frame analysis over many months [and compiled this into a video he posted on 30 Oct 2018](#).⁶⁰⁶

Burlington notes:

- Eye sockets appear to change shape (during coughing and examination by medics)
- Head moves in response to medic's action (several instances).
- Liquid appears to pour from the mouth and nose.
- Alien's reaction to torch held by medics
- Heart monitor changes in relation to the alien's condition and movement.
- He states that in a contrast-enhanced version of video, a military badge can be seen on the arm of the telepath.

- Arm of medic goes over the aliens head several times, showing that if it was a puppet, it wasn't operated by strings from above.
- Medic picks up a wipe or tissue, then puts this down and picks up something else – suggesting this was not rehearsed and didn't involve actors.
- Military aide, who is seen in deep shadow in the right-hand side, can be seen talking to the telepath as the alien is struggling to breathe.
- Objects on the table suggest authenticity as they would not be important in the nature of this video if it was a hoax.
- There are no edits/cuts in the video.

Burlington suggested that someone make a video to point out the flaws in the original video, or his own analysis, but it appears no one has done this.

Summary and Conclusion

People seem to think there are no real pictures and no real video of living aliens. The same is said by the same sort of people regarding the evidence for flying saucers/ET craft and their landings. In this chapter, I have tried to provide evidence that there are indeed pictures and at least one video of a live alien. I am not expecting my conclusion to “change the world.”

In the next chapter, we will examine what I think is the best evidence we have of a dead alien and the sad status of this evidence, as of the time of writing this book.

21. The Starchild Skull and Lloyd Pye



900-year old Starchild Skull – front and top view

Is it true that there is no publicly-exhibited physical evidence of extra-terrestrial life? Around the same time as I came across the Disclosure Project, I also came across the [Starchild Project](#)⁶⁰⁷ – which was centred around an unusual “deformed” skull, found in 1930. Sceptics dismiss the skull as the result of cradle-boarding and hydrocephalus. Below, we will discuss this fantastic relic and the person who taught us so much about it.

Lloyd Pye

Lloyd Pye, handled the Skull (literally and figuratively) from 1999 up until his tragic death in 2013. I first learned about the so-called [Starchild Skull](#)⁶⁰⁸ in about 2003 and less than a year later, I met and befriended Lloyd Pye and helped him transfer some 35mm slides into a Powerpoint file. [Late in 2004, I helped him set up a UK-based Website](#)⁶⁰⁹ for the Skull, to complement the existing one, which seemed difficult to get updated. I couldn't believe he didn't already have some support in the areas I gave him a little bit of help with. It was clear to me that the Starchild Skull was a find of vast importance.

I was immediately friends with Lloyd – his sharp mind, warmth, humour and humility were a rare combination. Within an hour of that first meeting, these qualities, along with his expression of gratitude to me, cemented a decade-long friendship. Over this period, I had the pleasure of accommodating Lloyd on several occasions and he was always gracious and appreciative. He was a friend to everyone he met. We shared the desire to pass on important information we had learned - to anyone that would listen.

We met many times and he came to stay at my house at least twice, when I organised talks for him in [Nottingham \(2009\)](#)⁶¹⁰ and in Derby. Amazingly, he also attended at least 3 of *my* talks – in London (2005), Gravesend, UK (2012) and the same Derby event in 2012. In 2004, he visited me with Amy Kelly, whom he was later to marry, after they moved back to the USA in 2005. Amy and Lloyd separated in 2011 or 2012.

Lloyd Pye's knowledge of bones and skulls came from [his independent research into Human Origins](#)⁶¹¹ – after which he concluded homo sapiens had been genetically engineered by another species. He wrote a number of essays on “Intervention Theory” and, as mentioned earlier, Amy Kelly compiled some of these essays and more of Pye's research into an important book called [Everything You Know is Still Wrong](#)⁵²⁴.

Due to the involvement of Pye in research into Bigfoot and Sasquatch, people have tried to deflect arguments away from the data presented in this chapter, when this doesn't really contribute to answering the questions that the skull presents. This is another common approach when artefacts of this type are analysed. In the next chapter, I will describe what happened to the research into the Skull in the years following Lloyd Pye's death.

In 2006 and 2007, [Pye wrote a book “The Starchild Skull - Genetic Enigma or Human-Alien Hybrid?”](#) - which told the story of the Skull up to that point⁶¹² and later, he published [an eBook “Starchild Skull Essentials,”](#)⁶¹³ which he updated several times, as new research was completed by a geneticist.

In 2012, Pye created [a 17-minute fact-packed video, containing all the essential information about the Skull.](#)⁶⁰⁸ Also in 2012, in Derby, [Pye gave a much expanded 2-hour presentation, which follows what is in the “Essentials” book](#)⁶¹⁴ (you can obtain this on DVD from me!)

Pye had a lithographic copy of the skull made by “Bones Clones” in the early 2000s, which he then carried around with him (before this he was carrying around the real skull!)

Starchild Skull – Not Human

The Starchild Skull is owned by Ray and Melanie Young of El Paso, Texas. It is a 900-year-old bone skull found in Mexico in the 1930s, along with the human skull (pictured in this chapter). Although it will not be difficult for you to find the online declarations that the Skull is human, below I present a [list of unusual features of the Skull, based on the summary which is on the Starchild Project's website](#)⁶¹⁵. This list proves beyond any reasonable doubt that the skull is not human:

Physical Characteristics

- The skull weighs half as much as human skulls of comparable size.
- The lower face of the Starchild Skull is much smaller than a normal human.
- It has no brow ridges, which all primates have.
- Its forehead is smoothly curved straight down to its upper eye sockets, unlike humans or any higher primate.
- The Starchild Skull's eye sockets are unusually shaped and are only 0.7 inches at maximum depth, compared to normal human eye sockets which average about 2 inches deep.



Starchild Skull



Human Skull found with it.



Human/Starchild Bone Thickness Comparison 9mm vs 3mm

- The optic foramens are shaped and positioned differently. (These are the openings in the back of a human eye socket, which let in the nerves and blood vessels for each eyeball, allowing it to function.)
- All that remains of the Starchild's lower face is the right-side maxilla. The roof of its mouth was flat, lacking any sign of a normal human arch, and like all of the lower face, it is much smaller than that of a normal human.
- The Starchild's zygomatic arches (cheekbones) are broken off, but from the small fragments that remain it is clear that the space between the cheekbones and the other bones of the face is much smaller than it would be in a normal human. This is significant because the chewing muscles for the lower jaw pass through this space, and so must have been much smaller than in a normal human.

- The Starchild Skull's ear holes are positioned lower on the head than in a normal human.
- The Starchild's inner ears are approximately twice the size of normal human inner ears.
- The Starchild's neck muscles attach in a way that indicates its neck was about half the size of a typical human.
- Unlike all humans, and indeed all primates on Earth, the Starchild Skull does not have an inion.
- Though the rear of the Starchild Skull is widely expanded and greatly flattened, this is not the result of deliberate binding or cradle boarding. This was verified in 2004 by Dr Ted Robinson and his team.
- The Starchild Skull's physical size is of a small adult in the range of 5 feet tall, or an average 12-year-old, which means its brain should be about 1200 cubic centimetres. An average adult has 1400 c.c. of brain. Instead the Starchild has 1600 c.c. of brain.
- The teeth of the Skull are a controversial subject, as many experts feel they show the Starchild was a child of about 5 years old, however the biting surfaces of the teeth are worn and ground to a degree that seems impossible for such a young child, especially one with smaller than normal chewing muscles. (So it may not be a "Starchild" at all...)

Internal Analysis

- At the top of the rear of the Starchild's head is a noticeable "crease" at the rear of its sagittal suture, where it meets the lambdoidal suture. The only possible way this can happen in a human skull is if there is abnormal fusion of the sagittal suture. A CAT Scan showed that no such abnormal fusion exists in the Starchild Skull.
- X-Rays, which showed the bone of the Skull to be half to one third the thickness of normal human bone, showed that it had no frontal sinuses, and showed no evidence of fluid or other abnormality between the brain and the inside of the skull.
- Scanning Electron Microscopy (SEM) Analysis discovered highly unusual microscopic fibres inside the bone of the Skull.
- The bone the skull is made of is much stronger but thinner than human bone, a feature possibly related to the fibres in the bone. Tests have shown that its chemical composition is also different – being more like tooth enamel (collagen).

DNA

- DNA tests done by Trace Genetics in 2003 were able to recover the Human Skull's Mitochondrial and Nuclear DNA, but only the Starchild's Mitochondrial DNA.

- Further tests done by an anonymous geneticist and lab between 2010 and 2012 recovered some nuclear DNA. Some sequences matched human DNA sequences, but others did not match any sequences from about 100 known species' Genome – stored in the NIH database.
- A 211 base pair fragment of Starchild's FOXP2 gene was recovered and compared to the exact same 211 base pairs in human FOXP2. Humans can have only 2 variations in this whole gene, both of which cause obvious defects in the subject. The Starchild sequence had 56 variations.

Following this research, the anonymous geneticist commented:

The probability that such a highly specific arrangement of changes in a small fragment could have occurred by accumulation of sequencing errors is extremely low, if not close to zero. Nor could this arrangement have occurred due to contamination with the DNA of any known species.

From this evidence one may conclude that the underlying biochemistry of the entity's life form must be either the same as, or highly similar to, humans or other species. Yet, the use of the genetic code, which still remains universal, is distinctively different, implying that this life form is very likely the result of a markedly variant and non-intersecting evolutionary process.

Causes

- The Skull was not deformed by abnormal fusion of the cranial sutures (the bone plates of the Starchild Skull are not stuck together in a way that stopped the skull growing properly and changed its shape).
- An extensive range of conditions including Anophthalmia / Microphthalmia, Apert Syndrome, Cradle boarding (and other artificial cranial deformations), Cruzon Syndrome, Hydrocephaly, Morgellons Disease, Trisomy 13 (Patau Syndrome), Progeria (Hutchinson-Gilford Syndrome), and Trisomy 9 (Mosaic) have been examined as possible causes for the unusual characteristics of the Starchild Skull, but so far no condition or combination of conditions has been found that explains the collection of anomalies possessed by the skull.

Paracas Skulls



Lloyd Pye did speak of the Paracas Skulls from Peru – which are elongated in a bizarre manner – such that they have a cranial capacity of about 3000cc (compared to about 1400cc in humans). Septic reductionists, once again, ignore evidence that though *it is possible* to change the shape of human skulls with head-binding, *it is not possible* to

increase the cranial capacity by a factor of more than two. [Brien Forster has had DNA testing done, but the results he has discussed don't seem](#)

particularly clear.⁶¹⁶ Also, it is not clear if the bone chemistry of the skulls has been tested, like the Starchild bone has been tested. Though there are several elongated Paracas skulls and only one known “Starchild Skull,” as far as I know, not as much scientific data and analysis about the former has been published.

Reaction to the Evidence

Only a few people in the academic community who have been asked to study the Starchild have taken it seriously. Almost everyone else has “turned their nose up” at it. For me, the only obstacle to *proving* it is the skull of an alien being is that we don’t have a publicly disclosed alien body, skeleton or DNA sample to compare it to! The totality of the available evidence shows the skull is unlike any human skull in almost all respects, other than its basic morphology.

Due to the evidence listed here – a high proportion of which is based on focused visual inspection, the only two available options for the majority of sceptics and academics are (a) to ignore the evidence or (b) to lie about the evidence.

Here, I relate the reaction of a certain Astronomer and Naturalist [David Aguilar of Harvard University](#)⁶¹⁷ when, in 2009, he was seemingly without warning, confronted with the skull in [an episode of the US History Channel’s episode of “UFO Hunters”](#)⁶¹⁸. In the clip, Aguilar pontificates about the evolution of alien life and, showing an artist’s impression of an alien on the screen – to the presenters Bill Birnes, Pat Uskert and Kevin Cook, argues alien life would not be like life here on earth, due to a different evolutionary process. Referring to a hypothetical alien, he says:

I’d love to bring one of these guys into a real lab and have everybody take a look at it.

Birnes et al then pull out the Starchild Skull lithographic copy and place it in Aguilar’s hands. Aguilar asks what he is looking and whether any DNA tests have been done. Birnes suggests it could be a human-alien hybrid. Aguilar, *with a deeply furrowed brow says*, “*prove it*”. Perhaps Aguilar is really saying

“Yikes! Actually, I don’t want to take this into the lab and have everybody look at it because I would be ‘finished’?”

Friends, Frustration and Funding

I shared Lloyd Pye’s frustration whenever people like Aguilar refused to *look at the evidence* – or just act like they can’t even see it. However, I also shared his delight when we would see people open their mouths in wonder – and try to comprehend why they had never heard about the Starchild Skull before...



Lloyd Pye and Andrew Johnson on 26 June 2009, waiting to go into the studio for a short interview during the weekend of the Leeds Exopolitics Conference.

The last time I saw Lloyd was on 18 Sept 2013, when he showed me the [Starchild Braincasts](#)⁶¹⁹. At that time, he told me more about a new development with the Starchild project. Lloyd explained that some months previously, he had gone to see a business man, based in Tampa Florida, called [Matthew Brownstein](#)⁶²⁰. Matthew was going to try and help Lloyd to develop skills for raising funds for the research into the Skull, as Lloyd felt he had not been very successful at this. Mr Brownstein himself became acutely interested in the

skull and started to do his own research. At this time, Lloyd and others were attempting to raise further funds for ongoing DNA testing and analysis which, for the previous 3 years or so, had been undertaken on a voluntary basis by an anonymous geneticist in the USA. The geneticist had the permission of the company he was working for to do this research, but the company, too, wanted to remain anonymous at that time.

Lloyd explained to me that Matthew Brownstein, following his own research, proposed that they form a legal agreement and a company, as a vehicle for furthering the goals of the Starchild Project. Although Lloyd didn't go into minute detail about the agreement, he told me that it was between Amy (his ex-wife), Ray and Melanie Young (owners of the Starchild Skull) and Matthew Brownstein. In 2013, [Matthew Brownstein set up a "crowd-funding" campaign for the ongoing research](#)⁶²¹, to which I contributed some money.

In the next chapter, you will learn about deeply troubling developments, which began in 2016, about 3 years after Lloyd Pye's death. We will examine and unpick unsavoury attempts to introduce doubt about the Starchild Skull - and Lloyd Pye himself. This should help to explain why it is unlikely you will hear anything else about the Starchild Skull in the foreseeable future.

22. Perception Management of the Starchild Skull Evidence

This chapter is based on an article I wrote in May 2017⁶²². I found it very difficult to write, because I had to point out the lies told by two people, who I thought shared the same goals (of talking about evidence and revealing important truths) as Lloyd and myself. However, the statements documented below essentially prove they wanted to insert doubt and/or attempt to discredit years of research, for which many sacrifices were made. I have included a lot of detail in this chapter because it so clearly illustrates that real and full disclosure about the UFO/ET issue is unlikely ever to happen when we still have situations like the one described below. I describe how two experienced but *lay researchers* (not *government connected researchers*), who have a special interest in the UFO/ET topic decide to *openly lie* about what they know about research that had been completed a decade before their lies were presented.

The So-called “Veritas” Show

Some readers will know of a subscription-based podcast/internet radio talk show called [The Veritas Show](#)⁶²³ which has been “on the web” since 2009, with all shows hosted by [Mel Fabregas](#)⁶²⁴. He created the show following his discovery of the [Milton Torres UFO-shutdown case](#)⁶²⁵ – Fabregas wished to interview Torres but “needed a reason” to do so. As a previous guest on the programme myself (in 2010⁶²⁶ and 2016⁶²⁷), I had a high regard for Mel Fabregas, not only because of his support for [Dr Judy Wood’s research](#)²³¹ and the fact that he has interviewed her several times, but also because he was a friendly chap who seemed to be trying to “do the right thing”. He had featured a number of interesting guests on his programme. [Perhaps things began to change for Mel Fabregas around the time he began to entertain the idea of a flat earth](#)⁶²⁸. [To anyone who can observe reality for themselves and do some basic calculations, hosting a programme like this is little different to hosting a programme about the theory that 2+2 might actually be equal to 5](#)⁶²⁹.

“Veritas” and The Starchild: DNA Testing and the Story Behind the Story

On 19 May 2017, I received a Veritas email update announcing the [interview with Starchild Skull Owner Melanie young](#)⁶³⁰. The description seemed to have some slight errors, so I was already slightly troubled. That is, it said:

Testing has revealed that both skulls were from individuals who had Native American DNA, but from different tribes.

This was information that I remembered being “correct in 2003,” but later testing revealed a rather more complex situation. Why didn’t Melanie Young, owner of the skull, know this?

I knew that there had been some disagreements within the Starchild Project since 2016, because I had seen the creation of Melanie Young's own "Starchild" website – which was rather peculiar⁶³¹. I had also briefly corresponded with Amy Kelly – another key member of the Starchild Project Team - about this situation. During the "Veritas" show, the troubling picture became clearer. The Veritas interview ran for just over two hours, but the second hour is/was only available to paying subscribers (which is kind of ironic, as you will read, below). A friend kindly donated a three-month Veritas subscription to me, which enabled me to listen to the second hour. In my analysis below, I will be "jumping around" a little, across the two hours, in order to point out some problems/errors I found. If you're going to accuse me of cherry-picking statements etc, you're going to have to listen to the whole thing, aren't you?

I spent quite some time carefully listening to the interview and transcribed parts of it (timings given below are approximate). This was an uncomfortable process, knowing what I know about Lloyd Pye and the Starchild Skull evidence.

Melanie Young, Who's She?

As mentioned above, Melanie Young owns the Starchild Skull - she had met with Lloyd Pye in 1999 and handed over the unusual skull to him, because of his expertise in the study of hominids and hominoids. Young confirmed this fact in the first hour of the interview. She also stated she is a UFO/Abduction experiencer – even to the point of stating she has had "hybrid alien children." She herself acknowledges that because of this, some people do question her sanity. (I do not judge Melanie Young on this issue. I have already written about such experiences, earlier in this book and [there are others such as Kim Carlsberg who have described very similar and deeply troubling experiences](#)⁶³².)

[You can listen to the first hour of the Young/Fabregas interview on the Internet Archive.](#)⁶³³ They discuss the story of the Skull and at 1:58 into the interview Mel Fabregas says:

"I didn't know [about] your name!"

The way that Mel Fabregas said this was odd to me - as if he was trying to say that Lloyd Pye had tried to keep Melanie's identity a secret. This initial impression seemed to be confirmed by the discussion which took place at about 28:23.

MY: He had no life but fringe science [MY talks about her business and family life]

MY: I stayed out of the way.

MF: You did to the point I didn't know who you were!

MY: Most people don't know who I am and most people don't know that I own it and even the people involved in the project attempted to take the ownership away from me.

Young continued:

*So, it's been interesting since Lloyd's passing on trying to get me out there for people to understand the story behind the story and to get the correct information because the correct information isn't out there. Except ... since I came on the scene about a year ago. **Lloyd did not tell the truth.***

This is a *direct attack on Lloyd Pye's reputation* and is clearly meant to *insert doubt*. Listeners can make up their own minds as to whether they think that Mel Fabregas, champion of Veritas, challenges these statements in any way – or comes up with *any* points of rebuttal to what Melanie Young says. There are some points that Young makes that Mr Fabregas should have known were wrong/untrue/misleading. Please read on.

The theme of Melanie Young being marginalised was revisited in the second hour when she said, regarding Matthew Brownstein:

He thought he was going to take up the torch but there was no way I was not going to be in the forefront again – you were not going to push me to the back of the pack.

The overriding impression I got is that Melanie Young was trying to say that the other members of the Starchild Project team (including Lloyd Pye) had tried to minimise and downplay her role and take away attention from her. What was really galling is that I *knew* Lloyd Pye had *never* done this and, when given the time, he had always clearly stated that Ray and Melanie Young were the owners of the skull. He said this at least in [2007 \(3 mins 50 into an interview with the Paracast\)](#)⁶³⁴, in an interview in [2008 \(10 mins in\)](#)⁶³⁵ and in [2009 – at the Nottingham presentation I organised and recorded – note the photo on the screen](#)⁶³⁶ (approx. 9 mins 42 into the presentation). Interested people can find many, many more examples of Lloyd Pye's interviews where he mentions her name. For Mel Fabregas not to know her name in relation to the skull must mean that he hadn't listened to the story of the skull very closely, or he had a poor memory, or he was deliberately misleading people over this issue.

Similarly, the Starchild Project Website also showed (at least by 2009), who the owners of the skull were – [here are links](#)⁶³⁷ [from the Internet Archive](#)⁶³⁸. [Even the current Website makes this clear](#),⁶³⁹ though there isn't a photograph of the owners.

Going back to Melanie Young's abduction experiences, at 25:00 in hour one, she stated:

When I found Lloyd, he was very clear that he did not want me talking about my abduction experiences. He did not want me doing anything with abductions and... related to the Starchild. To him it was like a battlefield.

Though Lloyd Pye may have said this to Melanie in 1999, or thereabouts, [Lloyd had clearly changed his mind on this sort of issue 4 years later – when he was openly discussing a possible connection between the Skull and Alien Abduction experiences](#)⁶⁴⁰ at some of his lectures. [He was still discussing these issues in 2009](#)⁶⁴¹. (As we shall see later, he was less inclined to include this material in his lectures from 2010 onwards.)

Intervention Theory

In parallel with furthering the research goals of the Starchild Project, Lloyd Pye had discussed other aspects of his research which seem to indicate that an off-world influence has been at work in the development of homo sapiens. This “Intervention Theory”, for example, is discussed in his eBook.⁶⁴² I bring this up, because in hour 1, at 26:58, Young stated:

MY: I just felt that comfortable with him. I did not know what his agenda was going to be. And his agenda all along has been to prove that aliens have interfered with our growth on this planet that we have been genetically manipulated. That's what he wanted to prove with the skulls.

MF: - Isn't that contaminating some of the research with your own - I don't want to say pre-conceived notions... Isn't that providing some of your biases?

MY: - Yes, so correct.

This was a peculiar comment – suggesting that Lloyd wanted to use the Starchild Skull to “prove himself correct” about Intervention Theory. Even if it had been true at one time, it was still a peculiar comment – *because it came from a woman who stated she had hybrid children!* (That is, someone who had been on the receiving end of “alien intervention!”) Fabregas seems to “join in” with this criticism of Pye, which is also inappropriate, as we shall see.

In reality, it appears Lloyd was more interested in gathering evidence about the Starchild Skull than proving his Intervention Theory was true. If Melanie Young had personally experienced “interference” by aliens, wouldn’t she, too, want to see her experiences validated by additional evidence?

As was saw above, Lloyd did talk about alien hybrid children – at least until 2009, but then, in 2010, more DNA evidence was given to him. [Following this, Lloyd clearly stated that it looked as if the Starchild Skull was not a hybrid](#)⁶⁴³. In his lectures, he describes how new DNA evidence changed his conclusions about the “hybrid” scenario. *Both Melanie Young and Mel Fabregas entirely failed to mention this* (another reason for me to write this article).

“Don’t Speak Ill of the Dead” – They’re Just After Money...?

This is one of those phrases that, when it is uttered, you can guess that the person making this statement is going to go against their own advice/statement. In hour one, at 29:35 this peculiar exchange takes place:

MF: There's a saying that goes like this "Don't speak ill of the dead."... A lot of researchers and me were invited to a private meeting in Pennsylvania...

MY: ... with Paul...

MF: Yes, I also saw a presentation at UFO congress in 2011 or 2012 and please people don't criticise me for what I am about to say... but I couldn't stay there for the entire time... because at one point I felt it was almost like an infomercial trying to collect thousands and thousands of dollars. Every other sentence had to do with "donate to this" and I understand if you need

*to conduct a DNA test and you don't have the funds and you go out there and try to get them. But the amount of money being requested was enormous and I don't know about you, **but how much does a DNA test cost?***

This was also extremely peculiar – not just because they were talking about a closed meeting of researchers and were clearly being cagey about the details, but also because *Mel Fabregas had already been told*, in some detail, about the cost of the DNA tests in *his own interview with Matthew Brownstein, conducted shortly after Lloyd's tragic death*⁶⁴⁴. At no point is the Starchild Project's 2014 research proposal (with cost estimates) mentioned.⁶⁴⁵ What exactly is the problem Mr Fabregas is trying to solve here?

The “money theme” is returned to several times in this interview, but the way the costs have been incurred or changed over the years is never properly discussed with accurate detail. For a more detailed summary, listen to the previously referenced interview with [Matthew Brownstein](#)⁶²⁰, or the one given on Red Ice Radio by [Amy Kelly](#)⁶⁴⁶ (whom Melanie Young attacks at several points in the Veritas interview.) I will leave the listener to make up their own minds about these remarks, once they find them. I would strongly argue that it is Amy's name that is the least well-known by those who are familiar with the Starchild Skull.

Money and Ownership of the Skull

Mel Fabregas further criticises Lloyd and the Project's fundraising efforts at about 30:50 in Hour 1, stating:

Why do you need 100s of thousands of dollars to continue an operation where some of the titles that I saw, including one – who I interviewed a few years ago... I am not gonna “name the names folks” - you can google it within our website - he is the last person who came onboard. Chief operating officer – things along those lines. Why do you need all this corporate board of directors - in such a fashion, that in order to keep that operation going, it almost looks like the muscular dystrophy association collecting funds every year.

Again, why won't he even mention Matthew Brownstein's name? Melanie Young does! What is the objective here? Later, Fabregas has to acknowledge that Melanie Young was involved in the formation of a company. In the second hour, they discuss the formation of the Starchild Project Company / agreement. At 2:55 in another peculiar exchange, they say:

MF: Do you now regret having given Lloyd the Starchild Skull

MY: No, the only thing I regret is signing any legal papers with the other members of the team.

MF: Oh, you did sign some legal papers?

MY: Yes, towards the end of Lloyd's life, after he was diagnosed with Lymphoma – or right before – within the last 6 months. When Matthew Brownstein came into the picture - that's when they decided we needed to have a business in order to get funders to get investors so that's when they took it to a lawyer he drew up paperwork on the operating agreement... So

they developed 2 companies. One I totally understood and it was about funding the research. The second one was explained to me that it was making sure everyone knew I was the owner but I was giving them **sole permission to do the research.**

MF: Oh my goodness so you were basically relinquishing your rights

MY: I didn't understand that I was relinquishing my rights but what really happened was I relinquished ownership.

MF: Which was worse.

MY: Which was worse. And again this was stuff that was pretty much forced down my neck because it had to be done and they had a time table and I was not given enough time to take it to a lawyer I trusted or I knew.

The idea of Melanie Young being forced into an agreement and given a time limit seems ridiculous. In any case, this agreement has now been dissolved! A little later in this discussion, Mel Fabregas again collaborates in trying to paint the original team members in a bad light:

MF: Even without those legal documents, they were in possession of the skull for **many years**, correct?

MY: For 3 years.

MF: So possession is 9/10 of the law so if they were in possession of that skull, and you didn't have any legal documentation stating it was yours, how could you prove that it was yours and **I am surprised you got it back.**

My understanding of this situation, from knowing Lloyd personally is this. When Lloyd was lecturing originally, and also taking the skull around to various experts, he was in possession of *the original skull*. At some point, however, he realised this wasn't a good idea – as it became clear it *was* very unusual and needed to be kept safe. At this point, an expensive replica was made by a company called “[Bones Clones](#)”⁶⁴⁷. Once that was made, the original skull was given back to Melanie Young and Lloyd mainly took the replica around with him. (There was at least one occasion – in 2007, when Lloyd took the *real* skull to a conference.) So, I assume from this, that the real skulls were returned to Melanie Young in about 2002 (1999 + 3 years). So, Mel Fabregas appears to be conspiring with Young to promote the idea that Young did not have possession of the skull for “many years” when in actuality, she had possession of it from 2002 onwards! If you listen closely, you will hear discussion of the skull's teeth, which were used for DNA testing. Hence, I am highly sceptical of Young's story of picking the Skull's up from Matthew Brownstein in Tampa (and no specific dates are given). The “*I am surprised you got it back*” statement from Fabregas can only be meant to cast the original project members in a bad light, suggesting they would try to keep possession of the skull against Young's wishes. This is clearly a ridiculous suggestion, when, as already stated Young had the skulls in her possession from 2002 or 2003!

At around 6:50, Mel Fabregas says:

Are you sure you have the real one?

That is, he suggests, Melanie might not have been given the real one back. Again, Fabregas shows a lack of knowledge here – because the real skulls have had segments of bone cut out of them for the testing – the replicas do not have these cuts. It would be totally clear if Young was given a “replica skull.” However, Young then says:

Oh the other one I have too. I know I have the real one because the copy has been destroyed.

Wow – why destroy a copy? I have my own copy of the Starchild Skull here and it wasn't cheap! Young then talks about having a museum quality cast made – but for what purpose, when she already had a good quality copy that has been “destroyed”?!?

The theme of money and ownership is returned to several times during the interview, with both of them trying to give the impression that Melanie Young was “taken for a ride” by disingenuous people. This is extremely upsetting. Why on earth would Melanie Young be associated with such people for over 15 years, without any such statements from her? Perhaps we will find part of the answer to this question later.

Age of the Starchild at Death

At several points in the interview, Young makes comments about the age of the Starchild at the time of death. For example, at about 41:07 in hour 1, she states:

All of the experts say it's 5 years old the only ones that say it's more than that is Lloyd and Amy. But all of the experts say it's a 5-year-old child.

This statement is false in both parts. The evidence regarding whether the skull was that of an adult or a child is inconclusive. This is clearly stated on the Starchild Project.com website in [Dr Ted Robinson's report](#)⁶⁴⁸:

17. A detached upper right maxilla contains two molars [recent note: one has been lost to testing]. Tooth wear on the molars indicates maturity was reached, yet another set of teeth are present in the maxilla and appear ready to take the place of those mature teeth when and if they are lost or are no longer useful. The question of age at death remains open.

Various experts are named on this page and so Young's statement about “all the experts saying it's a 5-year-old child” is glaringly false. Why is she, as owner of the skull, contradicting what was on the project website for *years*? Why is Mel Fabregas not familiar with this? Lloyd Pye and Amy had already accurately reported on the disagreements over the Starchild's age at death.

DNA Evidence/Update

At several points in the interview, there is discussion of DNA evidence – but some of the statements are vague and/or incorrect. [The second set of Starchild DNA tests were done in 2003 by a company called Trace Genetics](#)⁶⁴⁹ (which was later absorbed into another company). [Lloyd discussed all of this in considerable detail in his lectures](#)⁶⁵⁰. Young also tried to present the

impression that the Starchild Project have hidden data and reports. For example, at 7:57 in hour 2 she states:

MY: I never saw a report from Trace. All you ever saw in reality when you went to see one of Lloyd's presentations were screenshots or photoshopped pictures -

MF: Right

This statement must also be false as we shall see, and the remarks immediately following that statement are also made to, again paint Lloyd Pye and Amy Kelly in a bad light. (Fabregas again conspires in making these remarks.)

In hour two, Young makes further remarks about the 2003 Trace Genetics Report. At 9:21 she states

So when we started this new independent investigation with Chase, all of a sudden, the 2003 report from Trace Genetics shows up on the website. On the project website. Even though for the last year, I had been begging Amy for reports. She would never give them to me. She would always say "they're in the book or they're online."

This is a bald lie. [I found a copy of the Trace Genetics report in the Internet Archive dated June 2004](#)⁶⁵¹! I cannot believe that Melanie Young was either not given a copy or did not know it had been posted. Why can't Mel Fabregas verify the claims of his guests? "Verify" and "Veritas" – you can see the connection, right?

Young states that she had recently, through a person called Chase Kloetzke, initiated more DNA testing and that [Young's website currently contains results](#)⁶⁵² in [a report dated 28 March 2017](#)⁶⁵³, which states on Page 6:

The results for the nuclear DNA feasibility test were positive. There is sufficient nuclear DNA detected for future testing opportunities.

As stated by Melanie Young in the interview, the mtDNA results agree with those carried out 14 years ago and since the original 2003 tests, nuDNA (nuclear DNA) was recovered in further tests, as Lloyd described in his presentations between 2010 and 2013. Hence, the March 2017 report appears to contain *no new information*. In the interview, Melanie Young implies that further results were due in April or May 2016 (by my estimation). Mel Fabregas states near the end of hour 2 of the interview that he would record an additional short conversation about the results, if they became available. No discussion of these new results was included and neither is anything newer than 28 Mar 2017 posted on Melanie Young's Website, that I was able to find.

At other points in the interview, both Young and Fabregas question why it's taken so long for DNA tests to be done and a figure of 20 years (elapsed time) is mentioned by Fabregas (at about the 23-minute mark of hour 2) – disregarding the earlier discussion of the Trace Genetics 2003 test – which is covered in depth in Lloyd's lectures, as already stated.

Young makes further remarks around the 24:20 mark (Fabregas assists) which appear to be an attempt to discredit the (anonymous) geneticist that has been doing the research for free since 2010.

MY: People found Lloyd online and offered to help and the scientist found Lloyd and said that he could do the testing for free in his spare time at the lab he was working for so we went that route and he found weird stuff but nothing he could substantiate and he would not put his name on it.

So when Lloyd passed and I started really looking into it because no one else was doing anything. I tried to pick up the torch.

I started looking into this guy he's not a geneticist – he's a virologist used to work for the CDC – probably really good in his field – but he had no clue how to do human genome – nor did the lab he was working for.

We wasted time because he was willing to do it for free.

MF: Yeah but do what if he doesn't know what he's doing.

MY: That's my thought.

It's odd how this guy who “doesn't know what he is doing” was able to supply Lloyd Pye with detailed screenshots – from the NIH database – that show the DNA sequence matches⁶⁵⁴ (or lack thereof). Neither Fabregas nor Young discuss the FoxP2 gene, which was discussed in some detail in Fabregas' interview with Matthew Brownstein⁶⁵⁵ in Dec 2013. As an example, a question Fabregas *could* have posed would be, “What about the FoxP2 gene that Matthew Brownstein and I discussed in 2013?” This may, perhaps, have elicited a more appropriate response from Young. However, it seems that character assassination, not truth and evidence, was the “order of the day” here.

Discrediting the Original Investigation

It appears one of the objectives of this interview was to discredit the original “Starchild” investigation. What makes this conclusion so hard to believe is that the person being interviewed is *the very same one that “kicked off” the whole “quest” back in 1999*. However, at the end of hour 1 of the interview, Young makes the following staggering statement:

You go to the Starchild Project.com website - all of their information is old and not true. I don't like to speak ill of anybody, but their website has changed so much since Chase and I started the new investigation that they basically are mirroring what we're finding. So what you have seen in the past is no longer on that website – they've changed it completely. But they definitely are misleading on their website.

Chase Kloetzke and mine are totally scientific in nature – mine's a little bit more “story-telling” and that's www.starchildmelanieyoung.com

Now, it is quite easy for anyone to compare the 2 websites and it should, very quickly, become clear that there is *a lot* of information on www.starchildproject.com and not very much at all on the www.starchildmelanieyoung.com site (so the “mirroring” claim is also bogus). Being slightly facetious, and taking Young's statement literally, that all information on the Starchild Project website is “old and not true,” doesn't that mean that she is not really the owner of the skull and has, in fact, never been associated with the skull? (She did say **all** of the information is “not true.”) So

here again, we have a ridiculous statement – she never really states which specific information is untrue and cannot be true. Her sweeping statement if taken literally, discredits her own story/account.

Also, the statement about the www.starchildproject.com website having been changed since the “new investigation” is misleading. [A video of Chase Kloetzke discussing the new “investigation” was posted on 6 May 2016](#)⁶⁵⁶. To assess what changes took place on the Starchild Project’s website between, say Jan 2016 and the present time, you can access a [version of the website from Jan 2016 in the internet archive](#)⁶⁵⁷. Comparing that to the [current version](#)⁶⁰⁷, one can indeed see that the layout/style has been re-vamped, but the information is the same and I would argue that the newer version is clearer and shows a lot of information directly on the homepage (for example, the “Starchild For Dummies” video is the first thing you see now).

“Maybe It’s Hydrocephalic After All...”

Early on in the investigation, it was deduced this skull was not that of a hydrocephalic. This explanation is the one sceptics and debunkers immediately trot out when confronted with the evidence shown in this non-human skull. Lloyd Pye, and others (including myself) have gone to some lengths to show that hydrocephaly cannot explain the skull’s shape and form. Indeed, Melanie Young herself, in a [2009 interview with Bill Burns \(BB\) and others in the “UFO Hunters Team” was asked about Hydrocephaly](#)⁶¹⁸ and confirmed the skull could not have been from a hydrocephaly victim:

MY: If it were a hydrocephalic, this would be bulged out (pointing) but only one side would be bulged out, or the back would be bulged. It wouldn't be symmetrical like that is.”

BB: So a hydrocephalic skull is asymmetrical?

MY: asymmetrical...

BB: This skull is symmetrical...

MY: ...is completely symmetrical

MY: If that were hydrocephalic, the bones would not be connected. There would be no skull.

So, then, what possessed Melanie Young to say, at [20:26 in hour 2 of the 2017 Mel Fabregas interview](#)⁶⁵⁸:

MY: I am not ruling out Hydrocephaly anymore – I was at the beginning – because I bought into Lloyd – but I am not gonna rule that out – now that I've looked at it and ye know....

Again here, we see her implying that Lloyd Pye persuaded her. However, she had previously implied or even stated that it was her knowledge of human anatomy – and deformities in infants – which had shown her the form of the skull was not the result of hydrocephaly.

Shortly after this incredible statement, Young discusses Dr Aaron Judkins (an archaeologist who lead a dig for evidence of Noah’s Ark) and states:

Aaron Judkins is the only one to go on record claiming it's not hydrocephaly

This statement is also untrue. Point 8 in [Dr Ted Robinson's report](#)⁶⁴⁸ on the Starchild Project website reads:

8. Dr Bachynsky noted that there is no evidence of erosion of the inner table of the skull. Such erosion would be consistent with a diagnosis of hydrocephaly, so this condition can safely be ruled out as a cause of the abnormalities expressed. Hydrocephaly also causes a widening of the sutures, again not expressed here. There was consensus agreement to both of these observations by other experts conversant with these features.

Why did Melanie Young make these false claims?

Chase Kloetzke – The New “Investigator”

Several times in the interview, Melanie Young mentions Chase Kloetzke who, as indicated above, has allegedly “taken on” the investigation. In the interview, we learn very little about Kloetzke – certainly, none of her expertise is discussed in any detail, neither are details of why [Melanie Young appears to have put so much trust in this person](#)⁶⁵⁹. Kloetzke has a website, where she [gives information about her background](#)⁶⁶⁰ (and a lot of photos of herself are shown.) Her “bio page” states:

Chase earned her Master Trainer, Master Instructor title while employed with the Department of Defense. Armed with a Bio-mechanical Engineer accreditation, she was responsible for designing specialized programs and the supervision of complete success regarding Force Readiness, unique mission responsibilities and Elite Force Protection.

This information seems rather vague to me – is there anything which indicates she has a good knowledge of human anatomy, osteology, genetics or other related fields? So, Melanie Young criticised a geneticist (or virologist) working, gratis, in a lab intermittently for several years – who was supplying real data, but she is uncritical of some person that has recently come on the scene, has *disclosed connections to the US military* and lacks any obvious credentials to help with the investigation of the Starchild Skull? What is wrong with this picture?

2017 Nuclear DNA Tests

Also in Sept 2017. [Chase Kloetzke was interviewed](#)⁶⁶¹ by Martin Willis for the “UFOPodcast” programme. [Listening from 40 minutes](#)⁶⁶², it appeared she was doing “a muddle up” – jumping between [accounts of Steven Greer's Atacama Alien](#)⁶⁶³ (“Ata”) and the Starchild skull. Greer’s “Sirius” film does not categorically conclude that “Ata” is alien or human. In relation to this issue, [an article on the “UFO Trail” blog includes some interesting and useful dialogue with Dr Gary Nolan](#)⁶⁶⁴. Nolan strongly implies the Atacama creature is indeed human and he mentions meeting Lloyd Pye too. (That meeting happened in Sept 2012). Nolan plays down the Starchild Skull’s physical and bone anomalies, however.

Kloetzke briefly mentioned that a [new Nuclear DNA test had been done by a Lab in 2017 which “proved” the DNA was human](#)⁶⁶⁵. Closer inspection

reveals that this is not quite true. Here is what the report actually says, on pages 3-4.

The combination of replication, procedures in place for laboratory sterilization and elimination of Paleo-DNA Laboratory DNA profiles suggest the results are authentic and not contamination. However, no modern comparison samples were submitted with this batch from the archaeologists or any other individual who may have handled the sample and potentially contaminated it. Therefore, we cannot guarantee that these profiles are authentic and not a previous handler.

Kloetzke also reported that the sample was given to the lab “blind” and so they did not use any special recovery techniques. This article in [Nature implies that ancient DNA is at least 400 years old](#)⁶⁶⁶ (Lloyd Pye said that Ancient DNA was anything older than 50 years). The Starchild’s DNA, according to repeated Carbon 14 dating tests, was 900 years old, ± 40 years. Hence, it is highly likely that recovery techniques used in the latest “Kloetzke” test, didn’t actually recover the Starchild’s Nuclear DNA – they recovered other DNA. The test sounds quite similar to the [Bold Lab test done in 1999](#)⁶⁶⁷, where they claimed to have proved the skull was from a human male child. The Kloetzke report is brief and contains no images, for example.

I wrote to the lab to ask how much DNA was recovered – they kindly wrote back to me thus:

The 23 markers attempted in the report make up a very small percentage of the genome. I can’t be certain of the percentage. They are commonly used in human identification and paternal ancestry. Our recovery techniques are the same with all of our samples no matter the age. The goal of DNA extraction is to maximize how much DNA you can get from a sample. Age plays a part but the level of preservation of a sample plays an even larger part.

So, as Lloyd Pye said repeatedly, to prove the case fully, a full genome would need to be recovered – and it seems the previous (anonymous) geneticist might have been able to do this if funds had been available. Kloetzke did not make it clear that only *a tiny percentage* of the DNA had been recovered.

Kloetzke’s Errors

A number of incorrect or false statements were made in the Chase Kloetzke interview, for example at around 49:20, the host states the Starchild skull was “elongated” (it was not). Kloetzke nods and smiles and does not correct the host. At about 51:03, Kloetzke states that Lloyd was given fake evidence by experts. However, she does not name the experts nor does she describe the “fake evidence”. She also references the data/report on the FoxP2 gene which was revealed in 2012 and she describes these (51:55) as “not real science lab graphs – they’re photoshop graphs.” (My understanding is that the FoxP2 results were embodied in screenshots emailed to Lloyd by the geneticist. In any case, they are not really graphs – they are sequences of letters.) Kloetzke then proceeds to cast doubt on the anonymous geneticist’s credentials and even describes him as a “foreign national!”

At 53:00, referring to the Fox P2 gene research she says, “*geneticists don’t even talk like that.*” This is essentially a flat out lie, [as can be found in an article on the NIH website](#)⁶⁶⁸:

FOXP2 gene

forkhead box P2

The FOXP2 gene provides instructions for making a protein called forkhead box P2. This protein is a transcription factor, which means that it controls the activity of other genes. It attaches (binds) to the DNA of these genes through a region known as a forkhead domain. Researchers suspect that the forkhead box P2 protein may regulate hundreds of genes, although only some of its targets have been identified.

The forkhead box P2 protein is active in several tissues, including the brain, both before and after birth. Studies suggest that it plays important roles in brain development, including the growth of nerve cells (neurons) and the transmission of signals between them. It is also involved in synaptic plasticity, which is the ability of connections between neurons (synapses) to change and adapt to experience over time. Synaptic plasticity is necessary for learning and memory.

The forkhead box P2 protein appears to be essential for the normal development of speech and language. Researchers are working to identify the genes regulated by forkhead box P2 that are critical for learning these skills.

This is *exactly* as Lloyd Pye described in his lectures and presentations. So, who should we believe? It seems sensible to point out here, that as Kloetzke is attempting to debunk this evidence, it is very likely that it is *exactly* the sort of evidence Lloyd Pye suggested it was – evidence that this skull *was* from a being that *was not even remotely human*.

In order to try and make sure the “UFOPodcast” audience (and anyone else for that matter) had chance to get a more accurate picture of the facts and history of the Starchild skull, I wrote to the “[Podcast UFO](#)” website⁶⁶⁹ – which is referenced in the Kloetzke interview. Here is the message I sent.

Dear Sir/Madam

I notice you recently had Chase Kloetzke on your programme talking about the Starchild Skull.

I know quite a bit about the background to the skull and the lies that have been told about it. I have documented this thoroughly in an article I posted in March 2017.

I would like the opportunity to clear up a few misconceptions about the matter and therefore would like to offer myself as a future guest on your programme.

I can also advise you of other important UFO related evidence which few people will talk about.

Thanks for your time.

Andrew Johnson <http://www.checktheevidence.com/>

The response I got back from Martin Willis was as follows.

*Hi Andrew,
I am all set and want to move on to other topics.
Thank you,
Martin*

What Happened to Melanie Young?

In Nov 2015, over a year before I posted the article on which this chapter is based, I wrote to Melanie Young, enclosing a [link to a booklet \(36 MB download\) I had produced to accompany the talk\(s\) I was giving about the Skull](#)⁶⁷⁰. This booklet was basically a “total rip-off” of the information either produced by Lloyd Pye or posted on the Starchild Project Website. (If you work through this booklet, and through the 2017 Fabregas/Young interview, it should serve to further illustrate how bizarre the whole interview was.) Melanie Young replied to me on 05 Nov 2015 saying:

Thank you for your support. you have done a great job on your pamphlet. It is very well written. I know I couldn't [have] done a better [job] myself. I appreciate anything you could do to help me pick up were Lloyd left off. I owe it to him for everything he has done for me.

So, from reviewing this, as I just have, it appears that something happened to Melanie Young after November 2015, because her comments in the Mel Fabregas interview don't seem to tally at all with the statements in the email shown above.

There is further evidence that something serious has happened to her. [I found an audio of Melanie Young's presentation](#)⁶⁷¹ at the [25 Jan 2014, Border UFO conference, in Texas](#)⁶⁷². Here, she is in complete agreement with all the research on the Starchild Project Website and reports on it 100% accurately. She also has trouble describing what happened to Lloyd Pye (she almost starts crying). Her overall demeanour makes her sound like a different person – speaking in a clear and concise manner. This is also the case with her [presentation on 21 April 2015 at the Ozark UFO conference](#)⁶⁷³, where we can hear her accurately discussing the DNA evidence.

I ask the question then, what caused Melanie Young, in April/ May 2017 to lie about Lloyd Pye and smear other members of the Starchild Project team? Why did Mel Fabregas assist in this process – when he had previously interviewed Matthew Brownstein and when he had previously met Lloyd Pye? He did not challenge anything Melanie Young said and did not bring up any of the points I have made in this article.

After publishing the article on which this chapter is based, on 21 Sept 2017, Melanie Young wrote to me saying

Andrew

I wish you would have an honest dialogue with me instead of chastising me publicly. I have no problem having an open debate with you but not allowing me [to] address your attacks is just not fair to Lloyd or the starchild.

I posted on your sight Check the evidence and received an email [that] stated that it was posted. But I can't find it. I may not understand how your site works.

I thought we had a good relationship. I'm sorry that changed. You still have my utmost respect. I wish you the best.

Respectfully,

Melanie

You can view the rest of the correspondence on my website⁶⁷⁴. I offered to post her comments there, although she offered no corrections to the article above and no explanations for her actions. She did “beg me for help” but did not explain what help she wanted - or what help she thought I could give. Did she want me to help her pronounce that the skull was that of a human child? (She confirmed the Starchild Skull is still in her possession.)

The Final Curtain?

On 25 May 2017, as I had been expecting, a “full-on debunking” article, [trashing all the original research](#)⁶⁷⁵ was posted on Chase Kloetze’s blog/website.

Now that Melanie Young herself has become a debunker, it is the best possible outcome for the “secret-keepers.” Also, another irony can be observed – in the Fabregas interview, Melanie Young talked, at some length, about her “alien hybrid children” (that she’s never met). Yet the skull she possesses, examined and tested by many different experts and never shown to be entirely human, is not, according to her, unusual at all. i.e. her alien children are real, but there’s no proof of aliens (or non-humans) in the form of the Starchild Skull...

Also, in Sept 2017, Mel Fabregas wrote to me, upset at my article. However, he was not able to offer any corrections to what I had written, nor any explanations as to why he had conspired with Melanie Young in the telling of lies about Lloyd Pye.

Conclusion

If one considers that this chapter is twice the length of the previous one, this is an illustration of the fact that documenting the *lying about evidence* takes twice as long as *documenting an overview of the evidence itself*. (This is also the case in Travis Walton’s “Fire in the Sky” book).

In this analysis, I have tried to be dispassionate, but it has been difficult, due to the involvement of my late friend Lloyd Pye and because I know about the evidence being discussed. Also, I see a close parallel between what has happened with the “Starchild” Skull evidence and what has happened with [the 9/11 evidence that was brought forward by Dr Judy Wood](#)⁶⁷⁶. In these (and

similar) cases, bald-faced lies have been told both about the evidence – and the “messenger” presenting that same evidence.

From the discussion, analysis and checking that I have written about above, I conclude here that the Fabregas/Young interview served one or more of the following purposes:

- Introduce doubt about the reputation of Lloyd Pye and/or attack him.
- Introduce doubt about the reputation of other Starchild Project team members.
- Focus on funding/money issues, and imply the project was/is all a money-grabbing scam (ironically, some of this discussion is in an interview recording which sits behind a “pay-wall”)
- It was an attempt to discredit the previous “Starchild” investigation and “wind the clock back 18 years,” by re-presenting the disproved theory that the Starchild Skull is that of a hydrocephalic child.
- The new “investigation” fronted by Chase Kloetzke was a “perception management and cover up exercise” to prevent the Starchild Skull from ever being taken seriously again.

Perhaps the overall intent was to encourage those who have worked so hard to reveal the truth about the skull to “give up and walk away.” I hope that time will show that this didn’t quite work...

23. Dr Steven Greer – “Going Critical”

This chapter is based on several articles I have written over the years, in which I have tried to study and analyse the actions and statements of one of the key figures in the UFO/ET disclosure arena– Dr Steven Greer.

As I have already said or alluded to repeatedly, I found Greer’s “Disclosure Project discussion” and analysis of the links between the UFO/ET issue and the energy issue to be immediately compelling. He said that it was clear from the way these vehicles performed that they must use some kind of advanced “fuel-less” or extremely fuel-efficient power system. So, if you were to keep the UFO issue as “a matter of public ridicule”, this would, in this context, also keep the associated energy question in the realm of ridicule.

For the years between 2001 and about 2010, Greer seem to talk more frequently and in more detail about the free energy issue than he has in the years since then. I think there is at least one reason for this, which astute readers will already know by now, but it should be clear by the end of this chapter, if it isn’t already.

Co-opting by Deception

As I will attempt to show here, Greer has been involved in efforts to keep free energy technologies covered up and, in the process, he has tricked or deceived many good-natured, kind-hearted and well-meaning people – perhaps without them realising it. He continues to do this.

In my first book “9/11 Finding the Truth,” I attempted to illustrate how a cover up can be kept in place. I explain, for example, how I was used to help muddle up some 9/11 evidence – even though I had good intentions and did not fully realise what I was doing. I described many details about this in a 2007 article called “The New 9/11 Hijackers”⁶⁷⁷.

It seems to me that in most or all fields of “alternative knowledge” research, quite a few people that are trying to “do good” are being unwittingly co-opted or “herded,” in line with a wider agenda – without them even realising this. A very similar situation exists with the environmental/climate change movement. As I documented in my book “[Climate Change and Global Warming – Exposed](#)”³⁴⁴, almost everyone in the environmental movements has been deceived regarding the causes of man-made global warming and/or “climate change” and well-meaning people have been unwittingly co-opted into supporting measures which will not do anything to solve the underlying problems.

Free Energy

For many years, we have heard of “miracle” energy technologies which could end our dependence on (erroneously-named) “fossil fuels” and how these “free energy” technologies would not damage the environment in the same sort of way. We have all heard “stories” of “perpetual motion” machines,

super-efficient engines which either run on water alone or they act as some kind of add-on to petrol (gasoline) engines to improve efficiency. These stories usually end in the same way - the inventions or devices rarely see the light of day and the inventors or organisations involved seem to fade into obscurity. Collectively, we don't get any real access to the promised benefits of these devices or inventions. As a direct result, the wider public perception is that these devices don't work or the inventors/companies are frauds because they fail to deliver the benefits described. A good collection of examples of free energy devices can be seen in a video called [“Free Energy - The Race to Zero Point.”](#)⁶⁷⁸

SEAS Power

Returning to Dr Greer, at the same time he presented his Disclosure Project press conference, he started another initiative or group called [“SEAS”](#)⁶⁷⁹ Power” (Greer said the name was based on the idea of “Seizing Power,” though the “SEAS” stood for “Space Energy Access Systems”). Greer said he was going to run this initiative as a business - to find, develop and market energy technologies which were either “fuel-less”, “over unity” (i.e. they output more energy than they consume) or those very much more efficient than any existing technologies. This looked good and I, probably like many others, waited for announcements of positive developments. In 2003, Greer announced they would be beginning to market a device in the near future - he was in the process of final validation and of making an agreement with the inventor.

Greer did make it quite clear about the difficulties he was facing. I agreed with what he said - one could not expect the multi-trillion-dollar global energy interests to be very pleased about plans to produce clean and free energy which they couldn't meter - imagine a car that you didn't have to refill with petrol!

However, time passed and no news appeared – no new device was released. In radio broadcasts that Dr Greer did in 2004, he mentioned that the project had run into legal difficulties and the inventor had to withdraw from the agreement, apparently due to some confusion or other business agreements, contracts or something similar - so no device would become available – and other details seemed sketchy. Things all seemed to go rather quiet, with Greer making occasional radio/web appearances – but mainly to talk about the Disclosure issue rather than “SEAS Power” or the energy issue. It seemed that “SEAS Power” had “seized up”.

Aero2012

Then, somewhat surprisingly in May 2007, Greer announced a new initiative – [“Aero2012”](#)⁶⁸⁰. It was announced with the posting of a video of a presentation he gave. Interestingly, this presentation simply consisted of Greer talking to an invited audience. Although I agreed with just about everything he said, my concern was that he showed no evidence of any of the developments that

had taken place under SEAS Power, nor did he go into any details about the problems he had had with getting his previous device into production or general usage. There were two separate parts to this presentation. In the second part, at 3:00, Dr Greer said:



And remember every cubic centimetre of space in this room has enough energy to run the earth for a day... I'm understating - it's actually infinite. And the point is, to tap it and to rectify it and to get it to run this house with real power is an engineering and science challenge which has actually been met - by the aggregate people in this room who know how to do it. You'll be hearing from them. I'm just a country doctor from Virginia...

There were no comments or presentations from any members of the audience – indeed it was not even clear who was present.

In this 1 or even 2-hour presentation, Dr Greer did not even show a video, photos or PowerPoint slides of any research - nothing to describe or show his earlier “SEAS Power” projects – it was just a discussion of his experience and ideas for the future. He merely had a large screen TV with a shot of the Aero2012 website on it.

The Aero2012 and SEAS Power Websites

On closer examination, at the time the Aero2012 website was launched, it could be seen that it had an identical layout and even most of the same content as the SEAS Power website, then some 6 years old. The only things that seemed to have changed were the logo and the “colour scheme”.

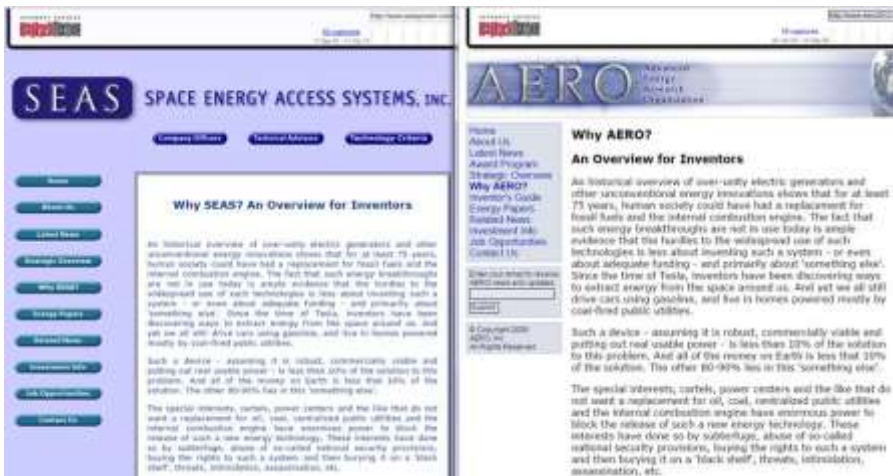

So, where were the details of the inventions, projects or devices that SEAS Power worked on? Was there *nothing* to show?

In June 2008, Dr Greer was interviewed on “The Paracast”⁶⁸¹ and he was asked some similar questions to the ones I am asking here, [so you can hear some of his responses](#)⁶⁸².

The Orion Project

Less than one year after the “cloning” of SEAS Power to make Aero2012, on [17 March 2008 he announced “The Orion Project”](#)⁶⁸³ In this announcement, he wrote:

The Orion Project has announced a \$3 million capital fund raising campaign so that these promising clean-technology energy researchers can be brought together in one place to build the initial proof of principle prototype to help solve the energy crisis once and for all. This prototype will be designed to meet all the energy needs of a typical home or business while having a zero-carbon footprint using new electromagnetic and related energy breakthroughs.

Curiously, [back at the Aero2012](#)⁶⁸⁴ this posting was then found, lower down the “news” page:

November 1, 2007 - AERO Announces [award program](#)⁶⁸⁵ offering \$200,000 up-front and \$5 million minimum two-year royalty for working, replicatable device.

Yet, the [Orion Project had a “donation” page, where, at the time of writing, they showed a message](#)⁶⁸⁶:

*total raised = \$295,340, *\$250,000 pledged by single donor contingent on public contributions for the remainder of the budget*

So, how was it the case that Aero2012 was previously offering a \$200,000 sum and up to \$5,000,000 but The Orion Project was proposing to raise \$3,000,000? And while saying/showing this, none of the three websites had any details of any existing or proposed projects...

HHO/Browns Gas/Meyer Cell Systems

At one time, on “The Orion Project” site, one of the systems listed as “promising” is the “Hydroxy Gas Energy System”. In one of [its news updates in December 2008](#)⁶⁸⁷, the Orion Project stated it had acquired the Stanley Meyer “materials”, though it did not state it was going to develop or produce a commercial system. Strangely, I first came across the work of Stan Meyer [in a UK Documentary “It Runs on Water!” first aired in 1995](#)⁶⁸⁸ – 13 years earlier! Did Greer have a plan for succeeding where Meyer failed? What does Greer think about the apparent death (by poisoning) of Stanley Meyer, I wonder?

However, it was already true that there were (and are) already a number of commercially available products (go and look for them) which can be fitted to cars to save fuel. Such systems have been available (if you know where to get them) for years, but only offer minor savings on fuel, to my knowledge.

Morphing the Money Grabbing

It seems fairly clear, then that SEAS Power just morphed into Aero2012 and then “The Orion Project.” We find no examples of technology that any of these initiatives have either introduced into general use, or even evaluated and discounted. Nowhere can we find out why these initiatives “failed” and neither are the results of any investment of time and research analysed or discussed. In 7 years, none of the initiatives that Greer had been involved with had produced any results that have been disclosed to the public. There is no information about projects undertaken, no names of people involved in them (apart from those listed as advisors) and there was no list of specific projects that are being worked on or any information on timescales.

Greer supporters might suggest that the reason for the apparent lack of results was to stop the “Powers that Be” from interfering with their efforts, but how long could this go on? Was the interference so great that all that could be done is to re-create a website with a different colour scheme, but the same information after a period of 6 years? By the end of this chapter, you should understand that it was not Greer’s intention to bring free energy devices into use. It is far more likely that his intention was to collect information about those things - then pass that information on to someone else.

Even with the later “Orion Project,” Greer had no new information and no new “plan”. ([When Greer was asked about this in a 2013 interview with him at the time of the Citizen’s Disclosure Hearings](#)⁶⁸⁹, he became somewhat uncomfortable talking about it – claiming that peoples’ lives had been threatened in the Orion Project. So what did the \$3 million Orion Project achieve?)

From Orion to Sirius

In May 2013, following a substantial and fairly well-organised marketing campaign (e.g. using ads embedded on websites), Greer released a new film called “Sirius.” Various embedded panels showed “Watch Sirius instantly for \$9.99; Available for a 72-hour rental period; Buy the DVD for only \$19.99”. The film has been “crowd-funded”, yet it was being sold.

[I reviewed this film soon after its release](#)⁶⁹⁰ (I quote some of that review below) because I knew that a lot of people would watch it and be taken in by Greer’s methods. [A related article by David Shewchuk about Greer and the film was posted on Henry Makow’s site](#)⁶⁹¹.

The setting at the very beginning of the film, is a lecture by Steven Greer. A scene shows people entering the building – and being body-scanned by a security person. Soon after that scene, the narrator ([Thomas Jane](#)⁶⁹²) says “Most people don’t know what a dead-man’s trigger is...” – well, googling this phrase reveals some odd definitions – most relating to TV or movies, it seems. In the early part of the film, no real evidence of any kind at all is discussed – and it becomes clear that the style of the film is one of “docudrama” – or something similar to that. The film runs for about 1 hour

and 50 minutes (but there are an additional 6 minutes of “credits” at the end, listing those who helped fund the film).

Atacama Humanoid - Evidence

Let us now turn to one of the “items” which is given the most exposure in the film – the so-called “Atacama Humanoid” (“Ata”) – an unusual humanoid skeleton, only 6 inches in length. As far as I can recall, this only came onto Greer’s “Radar Screen” after the Sirius film was first announced. Stories of this were circulated on alternative talk shows like “Coast to Coast” for some months – yet the “humanoid” itself was discovered in 2003 – 10 years before the release of the “Sirius” film.



Thankfully, the documentation about “Ata” can be found (free) on the “Sirius Disclosure Website” in a [Synopsis by Steven Greer](#)⁶⁶³. There is also a [report and summary by Dr Garry Nolan](#)⁶⁶³ and a [report on Radiographic Imagery \(X-rays\) of the being written by Dr Ralph Lachman](#)⁶⁶⁴. Neither the film nor the documentation give a definitive answer for what “Ata” actually is. The film briefly discusses that tests show that the mitochondrial DNA is more human-like than non-human. Curiously, there is no discussion of any nuclear DNA tests on the being.

I must question Greer’s interest in this skeleton, considering he has never mentioned or shown interest in the “Starchild” skull, discussed in chapter 21. (Lloyd Pye told me that he showed the skull to Greer in the early 2000s and Greer just said something like “Oh... it’s very interesting.” Perhaps Greer was briefed on the Starchild Skull and so knew what the plans for it were...)

[An analysis of some of the “Ata” photos by “Paolo V”](#)⁶⁶⁵ suggests “Ata” it is indeed a foetus and not a 6-year old child. Paolo V – suggests the lower 2 ribs have not developed and so there are only 10 in total. He points out the lack of developing/developed teeth (which would be seen, in some form, in a 6-year old child).

UFO’s, Free Energy, 9/11 and Secrecy

The “Sirius” film jumps around between different areas of evidence – and has a lot of “flash editing” in many places – switching between one of Greer’s

lectures or “retreats” and then segments of witness testimony. Topics covered include sightings from the 1950s onwards, Wilbert Smith (captioned “Wilbur Smith” in the film), the “Tether” incident (Space Shuttle Mission STS-75)⁶⁹⁶, footage from one or more CSETI expeditions and then the 1992 Gulf Breeze sightings (Florida)⁶⁹⁷, which Dr Greer contends was initiated because his group was attempting to communicate with ET’s at that time⁶⁹⁸. There is coverage of the Phoenix Lights (1997) with Dr Lynne Kitei and other similar topics we have covered in this book. The evidence is not as well-presented as in James Fox’s 2003 documentary “Out of the Blue”⁶⁹⁹ (which Greer was also involved with).

The film covered many different important topics – with perhaps only 1 or 2 minutes devoted to each one. Energy related topics include a mention of John Searle⁷⁰⁰, Thomas Townsend Brown⁷⁰¹, Dr Eugene Mallove⁷⁰², T Henry Moray⁷⁰³ and Tom Bearden⁷⁰⁴. Dr Tom Valone⁷⁰⁵ also appears several times to discuss some of his research.

The events of 9/11 are covered very briefly, and a, somewhat generalised, statement is made that “it is hard to concretely prove 9/11 was a false flag attack”. This is followed by short coverage of Kennedy’s “Secrecy” speech⁷⁰⁶, Cynthia McKinney’s question to Donald Rumsfeld on 10 Sep 2001⁷⁰⁷ about “the missing trillions” and there is mention of SAPS, USAPS and Black Projects. Importantly, no kind of link between 9/11 and Black Projects is implied or openly stated – the only possible clue that is given is that these things are covered one after the other in the film... No mention is made of the direct, established connection between the “free energy” issue, cold fusion and 9/11⁷⁰⁸, as shown in the research of Dr Judy Wood²³⁰ in her book “Where Did the Towers Go?²³¹” (Later in this chapter, we will cover some likely reasons why this most important evidence was omitted by Greer and/or his producer.)

Also introduced in the film is the “Sirius Technology and Research Initiative⁷⁰⁹” – yet another reboot of the earlier free energy information and money gathering scams, it seems.

Consciousness and Contact

One of the other topics mentioned is the all-important one of Consciousness. The analogy of our consciousness being something like a TV set, which we can “tune” to allow us to decode certain signals or frequencies, is briefly presented. Also, several segments of Greer’s CSETI retreats – to different locations – are intermingled with other footage. (Some of this footage has selected faces of people pixelated out). It is mentioned that Greer has been involved with training people to contact ET’s using methods such as Coherent Thought Sequencing and Remote Viewing. Absent in the discussion of “contact” is *what* is being communicated – and *who* – or *what* is on the other side of that communication.

“Unacknowledged” – Assisting the UFO Cover Up

“Unacknowledged” was the title of the film that Greer promoted in 2017. I chose the title of this book as a “play” on the title of this film – which was marketed in a similar way to the 2013 “Sirius” film, discussed earlier. “Unacknowledged,” like the “Sirius” film, was [made available on a “pay per view”⁷¹⁰ basis and a DVD version and a companion book were also released.⁷¹¹](#) Between May 2016 and November 2017, before the release of the film, I received over 20 emails about it from Greer’s mailing list. Here is a screenshot of a portion of an email sent on 20th March 2017 (and a similar or identical message was sent on 22nd March 2017).

Monday April 24, 2017 - Los Angeles, CA

“Dr. Steven Greer’s new documentary “UNACKNOWLEDGED” that presents brand new, top-secret evidence supporting Extraterrestrial contact including witness testimony, classified documents, and UFO footage while also exploring the consequences of ruthlessly enforcing such secrecy. Do not miss this historic opportunity to attend the world premiere in Los Angeles at the Regal Premiere Theater at LA Live!

Red Carpet with celebrities and Dr. Greer - 6:45pm-7:30pm. Presentation by Dr. Greer at 7:30pm. Movie begins at 8pm until 9:45pm. After Party 10:15 pm - midnight.

April 24, 2017 is the FIRST showing of the film to the public!
Digital viewing will be available May 9th.
Be a part of the excitement with Dr. Greer, media & celebrities to kick off our campaign to:

**“End Illegal Secrecy-
Begin a New Civilization!”**

[General seating - \\$30](#)

[Premium seating - \\$50](#)

[VIP seats - very limited - \\$250 each](#)
Includes poster and “Unacknowledged” book signed by Dr. Greer

[Exclusive afterparty only \(theater seating not included\) - \\$500](#)
You will be notified of the afterparty venue at the theater.

[All access seats and afterparty - \\$1000](#)
Includes: VIP seating, spend time on the Red Carpet with Dr. Greer and be a part of the Red Carpet excitement with media and stars, receive a book and poster signed by Dr. Greer and attend the exclusive afterparty following the showing of the film.

For all ticket options click [here](#).

In December 2017, I posted [Richard D Hall’s review/analysis of this film/movie⁷¹²](#). I suspected that, like the Sirius film, the “Unacknowledged” film and book would be a diluted, repackaged version of the 17-year old interviews that had first been presented in “The Disclosure Project” in 2001. (At least we can be thankful that most or all of these videos are available free on [Sirius Disclosure’s YouTube Channel⁷¹³](#)...)

Yes, he was offering a \$1000 ticket/package for the premiere! Below, I will heavily quote Richard D Hall’s analysis of “Unacknowledged.”

Hall stated:

There was nothing new in the film. Every speaker and piece of information I had seen before. It was very “broad brush” - no technical details. It was emotional, with Greer crying at one point. The film used highly emotional music throughout.

The moon landings were mentioned as being real on more than one occasion.

Richard D Hall and I have covered the Apollo Hoax extensively. For example, [Richard made an important programme \(number 249\) called “Analysing the Astronauts.”⁷¹⁴](#) I also wrote about the Apollo Hoax extensively in [“Finding the Secret Space Programme”⁷⁴²](#).

Hall notes:

Edward Snowden was mentioned as an example of a real whistle-blower who has exposed Non USAP (Unacknowledged Special Access Programmes) information - information less secret than alleged UFO related projects. Please see Richplanet programmes 240⁷¹⁵ and 247⁷¹⁶, which show that Julian Assange is not what he claims to be. One of Wikileaks most prominent “whistle-blowers” is Edward Snowden who I believe is a controlled CIA or NSA asset. Therefore making “mainstream media-aligned” claims about Snowden is aiding CIA/NSA operations, in my opinion. [i.e. Snowden hasn’t revealed anything about 9/11 or the UFO cover up.]

Hall further notes:

There is contradiction in what he [Greer] claims those running the cover up are doing. On the one hand the film goes to some lengths to show that mainstream media is controlled and ridicules the UFO and ET phenomenon, which is all orchestrated by those running the cover up. I would agree with this. But on the other hand, he claims that cattle mutilations and abductions are all being done by the military purely for the purposes of psychological manipulation of the public, to make people think UFOs are hostile. Presumably if they are making people think they are hostile, it means they are making people think they are real. This is a contradiction of his previous argument that their policy is to ridicule the subject to make people think aliens are not real. No evidence is presented for this alleged psychological operation, and no evidence is presented to show that the military are carrying out mutilations or abductions.

Hall also gave more details about the film being “old information” such as the fact that the film contains a discussion of the [Robertson Panel](#)⁷¹⁷, Condon Report, Blue Book, Paperclip, Nazi research, Ben Rich quotes etc. An old interview with Philip Corso was featured briefly, along with a few Roswell witnesses. There were a couple of new interviews, but no new information.

Hall noted that in the section on suppressed energy, no actual devices were discussed in any detail and, for example, Cold fusion/LENR was not mentioned. Eugene Mallove was shown very briefly, but not talking about cold fusion, he was just making some generic comments. Stan Meyer was mentioned and Greer stated that the authorities removed a “toroidal object” from Meyer that tapped energy from the zero point. No specific details were given.

There was no mention of the [TR3B](#)⁷¹⁸, [no mention of Ed Fouché](#)⁴⁴¹, even though there was much talk of development of secret craft from back engineered alien craft, as was discussed in some detail in my other book, [“Finding the Secret Space Programme”](#)⁴² Hall also noted there was no attempt to explain how the secret propulsion systems work. ([Richard Hall and myself have attempted to give this sort of explanation](#)⁷¹⁹, based on the information we have acquired and what we know of science etc.)

The development of secret weapons was mentioned, but no mention of 9/11 was made in this context. There was one shot in the film, very briefly of the building 7 “collapse”, but this was not linked to weaponry.

Hall stated he does not agree that the mutilation phenomenon is merely a psy-op, because mutilations have been occurring regularly for decades, all over the

world. Hall suggests that what is presented in the film may be to help *confuse* the mutilation phenomenon - to stop people looking for a *reason* for the mutilations:

He is effectively saying there is no physical or medical REASON for the surgical procedures and for the precise removal of organs and blood which are never recovered, and that it's just about creating FEAR.

The soft tissue and blood are not being removed for a purpose other than fear? So he is claiming that they take all of the blood without leaving any traces on the ground (which in the case of a horse is 40 litres), and they then dispose of the blood somewhere away from the mutilation site. They have no use for the 40 litres of blood that they take, they just transport the 40 litres of blood away from the site and dispose of it to “create fear”.

Hall states Greer is helping to cover up the true purpose of the mutilations and he also observes that Greer:

...seems to accept the fact that the energy technologies have been covered up, because there is NO argument in the film to request for them to be released. Instead he asks that people who are researching their own devices contact him for funding. Why does he not campaign for those people who are in the black world to send him designs for the devices anonymously? Or ask them to post them on public websites? We know from Greer's work on past free energy initiatives that he has actively collected intelligence on people who are working on new energy technologies, but so far, he apparently has nothing to show for it (after over 15 years).

In the next few sections, the truth about Dr Steven Greer should become a lot clearer. Hence, we can better explain the preceding analysis of his films and initiatives.

Dr Steven Greer – an “Open and Shut Case”?

In the previous sections, we saw the evidence of Greer's true intentions regarding the release of free energy technologies. We can see these intentions, from a slightly different viewpoint by considering what he said in a “workshop” he gave in April or May 2014, in Washington DC. (From what I saw of this, I couldn't tell if it was any different to a “lecture.”) Portions of this “workshop” were posted on YouTube, while [the full version could be rented or downloaded from Vimeo](#)⁷²⁰. In a second “free excerpt” from this [workshop](#)/⁷²¹lecture, he stated, at the beginning:

There was a time when I was willing to kind of play along with some of these inventors with their secret “proclivities” and that was a decade ago.

His voice and body language then imply he does not want inventors to keep secrets any more:

At this point the answer is no, “niet,” never going to happen... and the reason is if I know what the result is going to be at the end. You'd be insane to start it at the beginning, alright? So it isn't for nothing that since 1992 and 1993 I've been having meetings and doing briefings for the head of army intelligence... and the CIA director... and putting together presidential briefings and moving around with... you know... getting Rockefeller to host the Clintons at the ranch... to go through all this stuff with them... What I

have learned is where I started. **Disclosure. Complete openness about all these technologies.** You cannot fix this problem from the consciousness that created it.

However, only at about 8:25 into this same extract of the lecture:

You know at the World Economic Forum at Davos ... couple months ago, it came out that there [are about] 17 people in corporations ... that have about the equivalent of the net worth of the lowest 50 percent of the world's population... some of these folks I have met with - and briefed over the years. And in fact very recently, as some of you may have heard, **I can't go into any details about it. I was asked to go to an island, in the last few months, with about 120 world leaders - and people from Goldman Sachs and McKenzie and Boston Consulting Group and various people and I wasn't allowed to bring any assistance.**

Here, it seems Greer is stating he was involved in *secret meetings which he can't talk about* with some of the world's powerful business leaders etc. This is his version of “disclosure” is it? As we have seen, the above two quotes do seem to be quite in line with the way he has run his energy development initiatives. That is to say, that whether it was SEAS Power, Aero2012, Orion Project or Sirius Disclosure Technologies, Greer has consistently asked for money to supposedly fund free energy technology development, but rather than publicly demonstrate any device, it just seems he has been involved in “secret meetings he can't talk about.”

Dr Steven Greer and 9/11.

The section below is almost entirely copied from chapter 6 of my other book “9/11 Holding the Truth.”²⁸⁶

It is clear that Greer has been reluctant to tell the truth about 9/11 – such as when he wrote, in 2007, in an article entitled “Transformation of Risk” [originally posted on his Aero2012 Website](#)⁷²²:

This overview explains how the current risks of environmental global warming, air pollution and public health challenges, energy resource scarcity and competition, global terrorism and current electric grid obsolescence and vulnerability are transformed by these out-of-the-box technologies.

Years earlier, [Greer posted an article soon after 9/11, on his Disclosure Project Website](#)⁷²³. He wrote:

This is not to excuse in any way the evil, monstrous and inhuman acts of Osama bin Laden or others of his ilk. There can be no rationalizing such horrific deeds. But we can understand it: Why him, why us, why now: why. Fanatics like bin Laden are hell-bent on running America out of the Middle East because they view our presence there as a virtual invasion of their land, culture and values. They view us as an imperial power colonizing their region in order to secure cheap oil, and it is resented. To a lesser extent, they are concerned about our support for Israel, but bin Laden himself has made it very clear in numerous speeches that their main concern is getting the US out of Saudi Arabia, the land containing the most holy sites in the Islamic world.

However, on 21st November 2015, at the end of a 3 hour + talk⁷²⁴, Steven Greer faced a question from a seemingly informed member of the audience. Greer’s response seemed to clearly underline his support for the cover up of what happened on 9/11. He did not discuss any real evidence - nor did he wish to. Instead, he said very little of note. One might even perceive what he said as a warning - to *not* look at the available evidence...

Question: There’s compelling evidence that not just the towers, but the entire World Trade Centre Complex was destroyed by perhaps a directed energy type of weapon something that was operating on a technology of molecular dissociation - that seems to be very much related to what you’ve been talking about. Have you looked at that?

*Answer: I have looked at it - you know, I have bigger fish to fry... 9/11 was terrible - um we lost 3000 people... it lead to 2 huge wars and trillions of dollars... [Pause] I will tell you this. I’m not going to get into specifics. I mentioned] a gentleman named Richard Foche 3rd highest guy... Richard Foche at the Naval Research Labs he was in meetings with the then Vice President of the United States - Cheney - and he said “Absolutely it was known about in advance - and there was involvement at that level.” And he told me - and I have witnesses, multiple witnesses to this - that if he were to speak of this... (Now he’s passed away...) That he, his wife, his children and his grandchildren would all be killed. That’s all I am gonna say on the 9/11 issue. But there is a lot to that story - I’ve never shared publicly what I just said... but the man has passed away. So it’s not hard to ... and I think most people... get into these **grand conspiracy theories...** Basically all you have to do is stand down. There’s constant threat - there is terrorism out there... you don’t even have to hoax an event in that case ... You just have to stand down the systems that would’ve intercepted it. You understand what I am saying? So it’s like when you’re doing a ‘code blue’ ... “Boom! Clear!” You say “clear” before you do the electric shock. So you just clear the system and let it come in and hit... Now, what I think happened on 9/11 is more like what I just described and I have very good reason to believe that because someone of that integrity and rank had a front row seat - and knew about it - and I’ve never spoken of this before right now. But I think that .. it’s disturbing, it’s enraging, but it’s a minor rounding error compared to what’s coming if we don’t end this cartel’s hegemony on the secrecy related to UFO’s, ET’s what have you. 9/11 is going to be a very minor blip on the screen. So that’s my warning to people - you can take it or not. **But I’ve known what you’ve just asked about since it happened. My whole security team lit up** like you wouldn’t believe when that happened...*

If Greer had “known what you’ve just asked about since it happened” (i.e. the use of an energy weapon), why was he pushing the Bin Laden fable in his 2001 article, referenced above?

As a peculiar footnote to this subsection, I include a quote from page 285 of his 2006 book “Hidden Truth - Forbidden Knowledge”⁴⁷⁴:

*I am a big advocate of people acknowledging and being tolerant of people who are gay and lesbian, because I’m quite certain it is a natural variant of human existence which is present at the time of birth. The kind of wholesale bigotry that is attached to gender and sexuality will be a thing of the past. **It is already, unless you are part of the immoral minority who really do believe gays, lesbians and feminists caused 9/11!** The moral questions of*

our day have nothing to do with those issues whatsoever; it is a distraction from the real moral questions that should concern us.

Greer and SAIC

Science Applications International Corporation - SAIC were defendants in Dr Judy Wood's 2007 9/11-related Qui Tam Case⁷²⁵. This company was mentioned by several Disclosure Project Witnesses as significant benefactors of Black Budget Programmes. In 2013, SAIC split into 2 companies – and so they sometimes now go under the name LEIDOS. From SAIC's website (page 31 of the referenced PDF), we read⁷²⁶:

Following the September 11, 2001, terrorist attacks, we responded rapidly to assist a number of customers near ground zero in New York City and in Washington, D.C.

SAIC are involved in research or manufacture of Directed Energy Weapons Systems/Components⁷²⁷ (Listed as LEIDOS). SAIC oversaw ground zero security from 13.11.01⁷²⁸. Another speciality of SAIC is running Psychological Operations (PsyOps)⁷²⁹.

I think Steven Greer knows a lot more than he said here. Even going back to 2005, in an interview for Hustler magazine⁷³⁰, he says:

Q: Who else is making these phony UFOs?

A: The companies involved are SAIC [Science Applications International Corporation], TRW, Northrop, Raytheon and EG&G. We have enormous intelligence on this. I know the buildings where this stuff is going on. This needs to come out so people know the truth.

Why doesn't Greer show everyone, on a map, where said buildings are? Wouldn't that be some “disclosure”? Later in the same interview he states:

Q: Who's in this covert group?

There's a committee of 200 to 300 people who are on the policy board for this issue. Admiral Bobby Ray Inman, who went from head of the National Security Agency to the board of SAIC - which is one of the crown jewels of this covert entity - is a member. So is Admiral Harry Trane. George Bush Sr., Cheney and Rumsfeld are involved, as is the Liechtenstein banking family. The Mormon corporate empire has an enormous interest in this subject; they have much more power than the White house or the Pentagon over this issue. And there are secret cells within the Vatican.

I will just briefly mention here that Steven E Jones is a Mormon.⁷³¹

Greer says some interesting things on page 157 (or thereabouts) of his book, Hidden Truth, Forbidden Knowledge⁷³² (HTFK):

At a subtle level of electromagnetism, you can transmute elements, and also transfer something from one place to another - and infect or harm someone electronically. This is a very lethal application of a science that could be used to heal people. Unfortunately, right now, the worst elements of humanity currently possess these technologies.

When people worry about these technologies being disclosed, I say: “Forget about it. The worst elements already have them!”

From “Testimony of Denise McKenzie, former SAIC employee, March 2001”, Page 308 – 309, “[Disclosure Project Briefing Document](#)”⁷³³

Essentially SAIC is one of the crown jewels of the super-secret, black project world and is connected to UFO technologies and covert funding. Former NSA head Adm. Bobby Inman is heavily involved with SAIC, it should be noted. Here again, we see the revolving door between military and corporate projects described by Dr Rosin .

Greer and William Pawelec - and SAIC

This section doesn’t quite fit, due to the subject being Steven Greer himself. However, I couldn’t decide where else to put it in this book.

[William Pawelec’s interview/ testimony was recorded in year 2000 but only released in 2007](#)⁷³⁴, due to a request from Pawelec that it should be withheld until Pawelec’s death. William Pawelec was a defence contractor for a number of years. The link to this section of the book is that [Pawelec worked, for a short time for SAIC](#)⁷³⁵.



William Pawelec and Annie DeRiso

Pawelec seems to be an excellent example of someone who was disclosing real information – as much as he could – and at some personal risk.

He describes how he was working, in the 1970s and 1980s on implantable chip technology. This was very similar to RFID technology used since then. Pawelec mentions a “shadowy” but powerful group that seemed to “step in” to various projects he was involved with. In his 2000 interview, he stated:

*they have agendas totally unlike what our governments – what we perceive our government’s agendas really are and that they are able to **track unbelievably what’s going on around them – at a minute level.***

Also of note were statements attributed to [Pawelec’s widow, in an article by Mary Joyce, posted in 2011](#)⁷³⁶. Annie DeRiso reported:

“Bill and his friends also were involved with the development of the RFID chip. When they learned about the nefarious plans for its use, ‘The Powers That Be’ stole the technology. Two of those friends were assassinated and Bill’s own death remains suspicious.”

She also stated Pawelec had knowledge of a project to reverse engineer a craft, and this was at the Tonopah Test Range:

Even though Bill had seen a craft in the skies,” she explains, “what he saw in the secret facility beneath the Tonopah Test Range in Nevada left no doubt in his mind that beings from other worlds are here on Earth. Because of his profession, Bill knew all the buzz words to get someone’s attention which often led higher ranking individuals to tell him ‘secrets’ above his clearance level,” she says. “During one of those conversations, he was taken to a building at Tonopah where a large section of the floor is actually an elevator that goes down many floors. I don’t remember how far down they went, but Bill was taken to an area where they were reverse engineering a typical

saucer shaped alien craft. This is what he is talking about when at about seven minutes into the “Disclosure Project” video he kind of laughs and says ‘Our guys used to chuckle about the model not being quite right.’

According to DeRiso:

Another project Bill worked on was at Area 51... It was his job to upgrade the perimeter security systems for Area 51 and it was his idea to install cameras in fake rocks. It was during this time that he learned about the Tonapah base which is more remote and inaccessible than Area 51. It also was where Bill’s rose-colored patriotic glasses began to cloud over.

DeRiso also described what happened when Pawelec was attending what he thought would be a project status report at Tonapah, “held in a heavily controlled room that was built like a Faraday cage making it impossible for communications to come in or out of the sealed room.” She said

“Briefcases, papers, pagers and any form of identification were not allowed at that meeting,” Annie says. “Only the generals could be recognized by their uniforms. The tension was really high and Bill was surprised at how nervous the high-ranking generals were. He knew something BIG was up.

A private jet escorted by two of military jets landed and rolled all the way to the building where the meeting was scheduled.

“A very imposing man stepped out of the jet and entered the room. He was relatively tall, and wore a very expensive European suit. His shoes and briefcase were equally luxurious and there was an aide or bodyguard by his side. His demeanor was very aristocratic and he spoke with a High German accent.

“The room was electrified with nervous tension as each person gave his status report and answered questions. When everyone had spoken, the German man thanked them for their good work and simply left. He was never introduced nor identified in any way. It is believed he was [Baron Jesco von Puttkamer](#)⁷³⁷, one of the Germans who came to the United States with Werner von Braun.

DeRiso stated that it was this incident that drove Bill and a few close friends on a quest:

The men also wanted to discover the true alien agenda and the reasons they were interacting with humans... They concluded that while there are many benevolent extraterrestrials, the negative or dark ETs were using the Nazis, the Illuminati and the Bilderbergers as pawns in their plan to take over Earth and claim it as their own. They learned that a parallel battle for Earth has been going on in space for thousands of years.

Also of note is that. Pawelec stated that there were “factions of the New World Order” who were fighting each other for control. [However, it seems that in 2004, Pawelec made certain “apocalyptic” predictions which turned out to be incorrect – or at least, he got the dates wrong.](#)⁷³⁸

Greer and the CIA

In 2017, a [YouTube video](#) was posted of a radio/podcast interview with Dr Greer, in which he said the following⁷³⁹:

“In the 90s, I had 3 people on my team assassinated including a... very close friend.

[What has shifted now...]

*There were people in the agency who really wanted us to succeed – and I was gonna shut down this whole project when this happened... and they said “NO! You have to keep going... we need **someone on the outside - this has to be known...** our planet that’s going off the rails here...*

*I’m an emergency doctor working in an ER, taking care of shootings and all that stuff and I said “You know what? This is just getting to be too ridiculous..” and they said, “**Do you want executive protection?**” and I said “Whatdya mean?” and they said... “**Do you wanna be... have a [assisted?] protection - you and your team?**”*

*This was after the **CIA Director Bill Colby - who was going to help us bring out one of these free energy devices and bring it out to the world** – was found floating down the Potomac river – assassinated. And I said “Well, I really don’t like to play that game... it’s a very dangerous game – it’s called wet works..... But if they’re targeting my people, I said ‘I believe in self-defence – make it happen.’ So, I won’t say who this person is... still a very senior person – science director at the CIA – offered this protection and some other folks and I said ‘yeah let’s do it.’ So, since then, we’ve had no problems.*

Is this an open admission that Steven Greer is working for the CIA? It seems to me, then, that Dr Greer is controlled by the CIA and is therefore simply not able to tell “the truth, the whole truth and nothing but the truth.”

Greer Himself

Greer’s 2006 [semi-autobiographical book “Hidden Truth - Forbidden knowledge”](#)⁴⁷⁴ has quite a lot of revealing information about him. For example, on page 18 of HTFK, he talks about having a difficult/abusive childhood:

As a young adult, I once attended the movie “Mommy Dearest” with my twin sis-ter. Afterward, we looked at each other and said, “My God, that would’ve been the best day of our childhood!” People are horrified to hear this. Because of parental alcoholism, and home conditions that often attend it, we children also lived with elements of abandonment, neglect and abuse. I remember, as a little pre-schooler, eating cigarette ashes, sand, and dirt when nothing else was around. As a medical doctor, I now realize this was at least providing some of the mineral supplements my body needed: one of those instinctual cravings demanded by the body to enable survival. I was frequently very sick, especially every winter, with terrible pneumonias and bronchitis. My lungs still have scar tissue from those bouts.

This is not what I would have expected to read about the early life of someone who became an ER doctor. What else happened in his childhood? If he was literally starving because of neglectful parents, as he seems to be describing above, was he taken into care? Whose care was he taken into?

Another interesting statement on page 225 of the HTFK book is that he lived in Israel for 3 years (but he doesn’t say exactly when or why he went there).

The Dreaming

In chapter 9 of the HTFK book, he Talks about a precognitive dream he had, where George Bush’s plane was attacked and destroyed by a missile. He talks about having a dream of being with Barbara Bush dressed in black, going to the funeral. He phoned the secret service and told them all the details and he later read they’d changed some of Bush’s plans and also found evidence of a contract being put out on Bush’s life. On page 68, he talks about a “follow-up” dream he had:

After calling the Secret Service, that night I had another very lucid dream. Except this time, I was with Barbara Bush and we were all dressed in white, and riding white horses, and everything was light and very happy. It was clear to me then that the President would be safe.

Greer makes no comment about what President George Bush has done for world peace. A more appropriate version of this story would be:

“Whilst President George Bush was responsible for starting an illegal invasion of Iraq and he has lied about the events of 9/11, I must tell you about this precognitive dream relating to him, that I had...”

Greer doesn’t even make reference to what Bush’s father, [George H.W. Bush](#), a former director of the CIA, said in response to questions about UFO’s (acknowledging that he “knew a fair amount.”)²¹ This is of great concern, considering that Greer is [frequently heard to talk about concepts such as “Universal Peace.”](#)⁷⁴⁰ Why doesn’t Greer make some type of contextual reference to, for example, [the sordid truth about the dealings of the Bush family](#)⁷⁴¹, who supported the Nazi regime and helped Hitler? Does this indicate that Greer is, in fact, somehow tied in to the hidden power structure of the elite? Was he actually quite close to the Bush family? Were they, or someone closely associated with them, involved with Greer’s childhood, if he was taken into care, as we considered earlier?

Greer and Cancer

Greer tells of him being diagnosed with metastatic cancer on page 150 of his HTFK book:

By 1997, Shari and I knew that we were being targeted with increasingly powerful EM weapons. And so it came to pass that, within a short time span, Shari, a supportive Congressman and I got metastatic cancer. I am convinced that these were electronically induced.

The supportive Congressman that Greer doesn’t name here was [Steven Schiff](#)⁷⁴², who’d been asking [serious questions about the Roswell incident](#).⁷⁴³ [He died in 1998 of cancer](#)⁷⁴⁴. On page 283 of the HTFK book Greer writes:

Diseases that appear now to be incurable, ranging from cancer to AIDS to other infectious diseases— even severe injuries— will be curable.

He makes no mention of [Cannabis Oil](#)⁷⁴⁵, the [Gerson Therapy](#)⁷⁴⁶ or any other of the safe, non-toxic treatments and cures for cancer that have been available (if you know where to look) for decades. Also, I could not find where in the

book Greer describes how his own cancer was cured / successfully treated. I have never heard him talk about this either.

Rockefeller and Wolsey

Another area where Greer doesn't seem to have said much is in relation to the influence that some of his connections appear to have. [For example, the Rockefeller Family](#)⁷⁴⁷ have set up many foundations and institutions around the world – seemingly to fund initiatives which actually maintain the status quo in relation to things like energy, health care and so forth. In developing the original Disclosure Project, Greer was funded by Laurence Rockefeller. Was this just because of the philanthropist's “innocent interest” in the UFO subject, or was it so that Greer was controllable and the Rockefeller's would quickly get access to information he obtained in relation to “free energy” inventions? [It seems that the latter explanation is the more likely one, as described by a fully-referenced blog posting \(I couldn't find an author's name, however\).](#)⁷⁴⁸ But of course, [Rockefeller was one of the good guys really...](#)⁷⁴⁹ right?

[It's also worth reading an interesting analysis by Joel van der Reijden of Greer's other connections.](#)⁷⁵⁰ (However, this article also throws “the baby out with the bathwater” and does not examine any of the UFO/ET related evidence separately to the stated “web of connections” and seems to dismiss everything all the witnesses said, thus “Update: It's clear at this point that all of Greer's witnesses are intelligence assets and disinformers.”

This is fairly typical of those who are more interested in the seedy world of covert geopolitics than they are in subjects like human origins and other evidence discussed in this book. That is, they are essentially fundamentalist reductionists at heart...)

Do things like the Rockefeller connection indicate Greer was “groomed” so that he could circulate in elite circles, and then claim he has “briefed” high officials – such as James Wolsey, former CIA director under Clinton, on the UFO issue? As we can read, [Wolsey disputed Greer's claim back in 1999.](#)⁷⁵¹

Acknowledging Dr Steven Greer

In conclusion, I advise you therefore not to support Greer's activities – financially, or otherwise. (I sent Greer money several times between about 2003 and 2005, not realising what he was actually doing). He will likely continue to operate his dishonest money-making schemes. The evidence presented here should make Greer's agenda clear enough that you should know not to trust him. Perhaps his 2006 book should have been called “Forbidding Truth, Hiding Knowledge.”

Having said that, do not then simply distrust all the important witness testimony he gathered for the Disclosure Project itself, which in its original form seemed to be a mostly genuine effort to present truthful information about enormously important secrets.

24. Limited Hangouts? Disinformation?

Almost all UFO/ET researchers have been accused of putting out disinformation and you can certainly find various [lists of names on the web which claim to be accurate and forewarn readers of this problem](#).⁷⁵²

Here, following on from the previous chapter, I will document a little of my own experience with a few researchers and also include observations and some opinions.

As you have probably already realised by now, I tend to view most researchers through the “lens of 9/11 evidence.” I have known, since 2008, the most important aspects of what happened to the WTC on 9/11 – as Dr Judy Wood said, “The WTC Towers did not burn up, nor did they slam/fall to the ground. They turned mostly to dust in mid-air.” All the “veteran” researchers should know this as the truth by now. They should know that the towers *were* destroyed using a directed energy weapon of some kind and that this isn’t a theory, nor is it an opinion nor is it a hypothesis or “a view.” It is the truth – and it is knowable by studying the enormous quantity of evidence which shows this truth. 9/11 was the most important event in modern history – and most adults are aware of the event. Hence, it is the most important thing for researchers to “get right.”

If they don’t know this truth yet, then it means they have been lazy or not “paying attention.” So, when confronted with this evidence, for me, there are only two appropriate/honest responses which researchers should give. They are:

- “Yes, I already know this.”
- “Sorry, I haven’t studied the evidence enough yet, but will do so as soon as I can. Thanks for alerting me.”

If they, as “disclosure” researchers cannot learn this truth and speak this truth, I judge them to be unreliable. As such researchers, they cannot really come out with the same sort of excuses as mainstream figures do – because they are already operating in a field which does not accept official narratives. They should have learned to think for themselves and evaluate evidence properly. Again, the truth about what happened to the WTC is the ultimate “litmus test” for researchers. Those same researchers should be interested in and know that SAIC were involved in the events following 9/11 as well as [being involved in energy weapon research](#)⁷²⁷ – and black programmes. If they can’t discuss this blindingly obvious and important connection, they are not reliable. I encourage readers to ask their favourite researcher to evaluate [the evidence on Dr Judy Wood’s website](#)⁶⁷⁶ (once they have evaluated it and understood it for themselves) and then you can judge for yourself how a particular researcher responds.

So, my main message is, use discernment at all times.

Linda Moulton Howe

She has been working in the UFO/ET research field for many years and has, perhaps like Steven Greer, brought out or hosted a great deal of important information (for example, she featured the June Crain/James Clarkson Roswell interview that I referenced in chapter 5). William Cooper speaks highly of Linda Moulton Howe (LMH) in his “Behold a Pale Horse” book, noting that, like Bill Moore, there was an attempt to use her to put out disinformation. The attempt employed a character we mentioned earlier – [Richard Doty, who has repeatedly been shown to be involved in disinformation operations](#)⁷⁵³ (He was interviewed for Greer’s “Sirius Disclosure”⁷⁵⁴ and “Unacknowledged” films too.)

I had some contact with LMH in 2006, when I helped her set up an interview with Gary McKinnon. Since then, it appears that something may have happened to Linda Moulton Howe, [who won’t tell the truth about 9/11](#)⁷⁵⁵. [She won’t tell the truth about Climate Change](#)⁷⁵⁶ or [vaccinations](#)⁷⁵⁷ either – instead, she just repeats mainstream thinking (or “what ‘scientists’ claim is the truth” about these issues.)

Also, LMH has promoted Elon Musk’s alleged Mars exploration programme – which is less advanced than the NASA programme was 30 years ago. [In a 2018 conference panel “Q and A” about disclosure issues, she said:](#)⁷⁵⁸

There is A jump-start that is coming and it is Elon Musk. If he does what he says, he will be launching to Mars in 18 months, in the year 2020 and if Elon must survives, and we have then a public discourse of a base on Mars, automatically the six o’clock news around the world is going to be getting reports from Elon Musk on Mars. Once we are in that environment, which could be in two years from now, we already have gone from an earth-based news and human earth population - to Earth and Mars and that, to me, will be the beginning of a whole new... it doesn’t matter who has announced or confirmed... we will already be a new space-faring civilization.

Clearly, Howe has not studied the situation carefully – I hope she reads my [“Finding the Secret Space Programme”](#)⁴² book.

Additionally, when Richard D Hall contacted LMH in 2009 in relation to his investigation of cases of animal mutilations, [she suggested photos of a Brazilian human mutilation case were the result of exposure to Agent Orange](#)⁷⁵⁹! Not only did this not explain the way the corpse was horribly mutilated, LMH seemingly had no information on who was releasing Agent Orange in Brazil...

Stanton Friedman

Much as I like Stanton Friedman and his methods, mannerisms, approach and demeanour, he seems to be mainly focused on a few aspects of the UFO/ET tapestry. He is very good at responding to emails and even sent me copies of some of his documents free of charge, a few years ago. (This included a copy of his [“Cosmic Watergate” paper](#)⁷⁶⁰.) Though he has probably made *some*

money out of his books and lectures etc, this has never struck me as being his prime objective.

He seems much more focused on the gathering and analysis of documents and some witness testimony. However, he does seem to stick within certain boundaries and doesn't seem as responsive to investigating certain related topics as I would hope. I was happy when I actually met Stanton Friedman in September 2015 at Gary Heseltine's "UFO Truth" conference, at which point I presented him with a copy of Dr Judy Wood's book "Where Did the Towers Go?" – the importance of which can never be understated. Following my gift of the WDTTG book to him, in July 2017, I decided to email him for a comment about it.

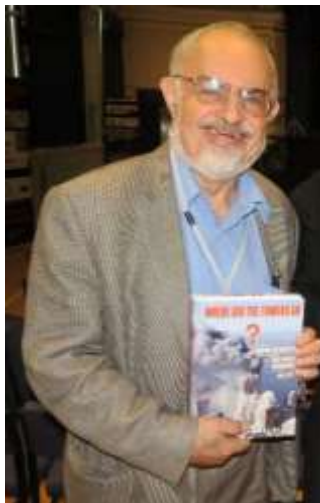

Stanton Friedman at the UK
UFO Truth Conference, 19 Sep
2015

I attached the photo shown here to remind him of the occasion. I did not receive a reply. About 3 weeks later, in early August 2017, I emailed him with a subject of "What are your thoughts

on the [Peruvian Mummy](#)⁷⁶¹ - I know what mine are! :)", and asked him for comments. (I suspected, myself, that this was a hoax, though I admit I didn't thoroughly investigate the case, which was heavily promoted on Social Media.) Stanton's response arrived in my "Inbox" under 3 hours later... (This had been my experience previously, that he was very prompt at responding to emails.)

One thing that surprised me, however, was when I wrote to him on 8 September 2004 and expressed to him my agreement with Steven Greer regarding the importance of the energy phenomenon in relation to UFOs, and other elements of the Disclosure Project. Friedman replied in a few hours:

From: Stanton Friedman <fsphys@rogers.com>

Sent: 08 September 2004 15:51

To: ad.johnson@ntlworld.com

Subject: Re: Hello from the UK

Andrew:

Thanks much for the detailed letter....

I think he missed the boat in Washington by not using the Government's own documents (Blue Book Special Report 14, the Congressional Hearings, The Condon Report, the Bolender memo, the blacked out and whited out CIA and NSA documents).. these should get the press salivating. Personal testimony takes a great deal of effort to verify.

*But this is what the government said and these are the lies they told. and here is what they blacked out or whited out.... **Also I think it is a bad***

mistake to mix so called free energy devices (he provided no evidence they exist .. even if they do, are they cheap enough for common usage) and flying saucers.

This struck me as rather odd - Friedman did work on Nuclear Based Rockets in the 1950s or 1960s⁷⁶² and so one would have thought he would have a keen interest in the subject of “free energy” and similar topics. However, if one looks at his website and listens to his interviews, he mainly focuses on the Roswell Case (he was the first civilian investigator) and a few other crashes, the Betty and Barney Hill case (particularly the “Star Map” aspect of this) and the “Flatwoods Monster⁷⁶³” Case. Another one of his major contributions has been the study of various government documents, such as Special Report 14 and the so-called Majestic Documents, of which he states that he hasn’t been able to prove them fake.

He has invested a lot of time and money (of his own) in doing very detailed investigations, but as I have stated many times about other researchers, seems to be missing the point of some things. He has done an excellent job of demonstrating the UFO/ET cover up in his analysis of documents (see the afore-mentioned “Cosmic Watergate” paper⁷⁶⁰, for example.) But somehow, he does not seem passionate about the implications of the cover up – and has never, to my knowledge, discussed the weaponisation of black technology – surely a logical conclusion from both the research he has done and his involvement in secret, technological programmes related to ballistics?

Again, perhaps it is just a character trait, but he doesn’t really seem to care about the results of decades of secrecy and I have rarely heard him speak in any detail about things like propulsion technologies or the deeper implications of the physical evidence of UFO cases. Another example of this was related to me by my friend Lloyd Pye, who had a table at a conference which happened around the time of the 60th Anniversary of the Roswell Crash. Lloyd had, on that occasion, taken the *real* Starchild Skull to that particular conference. He was on a table near Friedman’s and repeatedly invited Friedman to come and hold the skull and examine it. Friedman did not take up the invitation and seemed disinterested. In common with many other UFO/ET researchers, Friedman never seems to mention the Starchild Skull.

He seems happy to just quote his summary, thus:⁷⁶⁴

THE UFO CHALLENGE - December 1997 - By Stanton T. Friedman

As a nuclear physicist who has had a serious interest in flying saucers since 1958, I have reached four major conclusions:

- 1. The evidence is overwhelming that Planet Earth is being visited by intelligently controlled extraterrestrial spacecraft. In other words, SOME UFOs are alien spacecraft. Most are not.***
- 2. The subject of flying saucers represents a kind of Cosmic Watergate, meaning that some few people in major governments have known since July, 1947, when two crashed saucers and several alien bodies were recovered in New Mexico, that indeed SOME UFOs are ET. As noted in 1950, it’s the most classified U.S. topic.***

3. *None of the arguments made against conclusions One and Two by a small group of debunkers such as Carl Sagan, my University of Chicago classmate for three years, can stand up to careful scrutiny.*
4. *The Flying Saucer story is the biggest story of the millennium: visits to Planet Earth by aliens and the U.S. government's cover-up of the best data (the bodies and wreckage) for over fifty years.*

Stanton was saying the same thing when I became much more familiar with his research in the 2003 – 2005 period and, 13 years later, has not added anything. However, this is not to say that he has not made an enormous contribution to the field of UFOlogical research in the last 60 years!

Steve Bassett and Disclosure Advocacy



Steve Bassett April 2017

Some of this section is from chapter 12 of my other book, “9/11 Holding the Truth,”⁹³ but because Steve Bassett has been directly involved in UFO/ET disclosure initiatives, it was appropriate to include it here too. However, in the other book, I do provide some further commentary on several other UFO/ET researchers who do not appear to be being honest about what is known about 9/11, so please consider reading that volume too.

I first wrote to [Steve Bassett in March 2004 to congratulate him on an appearance on Fox News](#)⁷⁶⁵

in relation to a film of UFOs that was released by the Mexican Military, after UFOs were tracked and filmed by them for an extended period. [This story received international coverage](#)⁷⁶⁶ and, as far as I know, remains unexplained (at least, in the white world...) Bassett made a good presentation and was taken seriously.

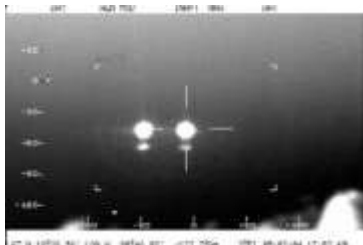

Still from Mexican Military Patrol
Film shot by Infra-red cameras

However, Steve Bassett has been in a “holding pattern since I first heard his name” - and has repeatedly suggested that the US President was about to disclose information about UFOs and ET’s etc.

So who is Steve Bassett? [From his website](#)⁷⁶⁷:

Stephen Bassett is the executive director of Paradigm Research Group founded in 1996 to end a government-imposed

spoken to audiences around the world about the implications of formal “Disclosure” by world governments of an extra-terrestrial presence engaging the human race. He has given over 1000 radio and television interviews, and PRG’s advocacy work has been extensively covered by national and international media. In 2013 PRG produced a “Citizen Hearing on Disclosure” at the National Press Club in Washington, DC. On November 5, 2014 PRG launched a Congressional Hearing/Political Initiative seeking the first hearings on Capitol Hill since 1968 regarding the extra-terrestrial

presence issue and working to see that issue included in the ongoing presidential campaign.

For example in, May 2000, Bassett wrote:⁷⁶⁸

The status and power acquired by the military/intelligence complex during the Reagan years and the end of the Cold War symbolized by the dismantling of the Berlin Wall in 1989 set the stage. The senior Bush was the perfect president to have in office. It is this author's belief the process of disclosure was thus set in motion to occur early in Bush's second term (1993). The same circumstances set Col. Philip Corso in motion toward his eventual 1997 memoir, The Day After Roswell.

I think this description relating to Bassett's previous statements, from a site called UFO Watchdog is accurate⁷⁶⁹:

Bassett has developed the idea that Disclosure is something that insiders want to do, but that it depends upon who is President before that can happen. He says the Cold War precluded Disclosure and since the Cold War it has depended on the correct President. Bush 1 would have worked, but he didn't get re-elected. Drats, delayed again! Clinton would not work, and neither would Bush 2. At the 2009 "X-Conference" Bassett gave President Obama an ultimatum that "He better disclose by May 31, 2009 or else another country probably will before then." Apparently he had high hopes for Obama, the perfect president to invoke Disclosure, who just hasn't come through for him either. It must be a great disappointment.

However, this is a sceptical website whose goal is to downplay the significance of the UFO/ET issue and ignore evidence when it suits them. (If you listen to their Podcasts/recordings, you will find some of them overly antagonistic. Additionally, for example, if you listen to the one with Lloyd Pye⁷⁷⁰, they criticise him and/or the evidence he presented - after the conversation has ended, when he has no chance to respond.)

Bassett is interested in the weaponisation of black technology. This came up in a round table discussion on Sat 28 June 2014, (at 21:40 in)⁷⁷¹ at the 2014 "Secret Space Conference" held in San Metino California⁷⁷². He said

*One of the very possible reasons why the secrecy has been so profoundly maintained is that the power of the energy systems and technologies being worked on as well as the antigravitic technology – **if it gets in the wrong hands could be a serious problem.** I'd like to mention something you may have forgotten about. Back in 1991/92 there were articles which I read that the military kind of had a problem in that they had been developing a huge range of sophisticated weapons and were very frustrated that there wasn't a war they could use them in....*

He then mentions Saddam Hussein and Kuwait and he talks about the Gulf War and how it was shown on TV in graphic detail. Then at about 24:30 into the discussion, he says:

Maybe the secrecy is because these weapons, if they get in the wrong hands, could be dangerous. I would like to make the suggestion that they are already in the wrong hands...

Of course, if Steve Bassett had referenced or described Dr Judy Wood's book at this point, he would have been able to illustrate that he was, indeed, correct! *He would have been making an observation, not a suggestion.* Would that not have

increased his credibility – referring to a comprehensive, publicly available investigation by a scientist, [part of which had been submitted in a court case](#)⁷⁷³? This investigation (contained in “Where Did The Towers Go?”) even includes reference to certain antigravitic effects discovered by John Hutchison and inspected by Col John Alexander in 1983⁷⁷⁴. I mentioned Col John Alexander, because Steve Bassett should know about him as a [UFO commentator – Alexander has strong military ties and knowledge](#)⁷⁷⁵.

Here is what Steve Bassett said when asked if he believed the official [account of 9/11 at the UFO truth Southern Conference on 29 Apr 2017](#)⁷⁷⁶:

Q: Steve, do you believe in any way the official version of [the events of] 9/11?

A: Well the answer is... do I believe that the investigation of 9/11 – which they didn't want to do until they were forced to by the women victims Which was an utter insult to the American People – unbelievable – the investigation is not full, is not adequate and there are major discrepancies. We do not know the full story. We have 100 theories, all of which cannot be right. So essentially, one of the most important events in American History. And again, just like so many other things – left unresolved - because “you don't need disclosure” – you're just people. As far as what's going on and my principal focus here.... **I know Richard Gage very well... The number one problem for the government is Building 7...**

Why would Bassett highlight that he knows Richard Gage? To confirm that they are both members of the same “cover up crew?”

As with Dr Steven Greer, Bassett should be honest about what is known about 9/11 and how it connects with the UFO/ET issues. As with Greer, Edgar Mitchell and many others, he seems to be deliberately (or based on instructions) adopting a “limited hangout” position. Not only that, but in relation to 9/11, at least, he promotes disinformation.

Similarly, Bassett has [promoted the CIA-run fake disclosure initiative called “To the Stars Academy”](#)⁷⁷⁷, which we will cover in more detail next. Bassett has also been reported in the mainstream press as [saying that aliens prevented the onset of World War III](#).⁷⁷⁸

Will Tom De-Long “Take us To The Stars”?

On 11 Oct 2017, Tom DeLonge (“TDL” below) [former member of Rock Group “Blink 182”](#)⁷⁷⁹ and author of a book called [“Sekret Machines”](#)⁷⁸⁰ hosted a live streamed presentation titled “To The Stars Academy” (referred to as TTSA below) from a large room or hall (which either had no audience, or a very quiet one). [I wrote about this event in a detailed article, posted on my website in October 2017.](#)⁷⁸¹ The text in this subsection is a summary of that article.

The event had received considerable coverage in the alternative media for quite some time before the “live stream” event – portraying it as the next big thing in the UFO/ET Disclosure movement. Over a year later, figures involved in the initiative are still receiving media attention.

Introductory Video

The presentation started with a sort of “trailer” video that Tom DeLonge (TDL) made in 2015, giving a summary of his previous exploration of “a topic that had already over 70 years of research, opinion and quite frankly effective disinformation.” In 2015, he met with someone in the DoD who worked in Special Access Programmes in an area called “Watertown” – also known as area 51. He reported that following this, he had a number of clandestine meetings at different places in the USA. From these meetings etc, he learned

1. Certain things should never have been secret
2. There were secrets that were justifiable at the time but should now be disclosed
3. There are things which are so unimaginable that certain interests believe that they should never ever be made public.

I don’t know if TDL has given any examples from the first 2 categories and explained why they were kept secret.

According to their own statements, TTSA took in about [\\$1 million in donations](#)⁷⁸² in a short period following the presentations.

DeLonge’s Lengthy Introduction and “Science Fiction Stories”

DeLonge then goes into the main presentation and gives a little personal background and reported that after he had been paid for a record deal, he bought himself a personal computer so that he could “research the possibility of intelligent life in the Universe.” He said he then catalogued and highlighted small pieces of data. He said, “my passion helped me envision a more interesting existence for us all.” He then explains how he used his “notoriety” as a musician/artist as a “door-opener.” He explains he started a company called “To The Stars” which was a “creative machine” to help him discover, comprehend and communicate large themes about the human race.

He started a company that could *create science fiction stories* that would “inspire entertain and galvanise thinking.” He said that we would be surprised to learn how difficult it is for major film studios to “create progressive content that is relevant, modern and just plain cool.” He said that he had met with all of them and their “hands are tied in many ways.” He said he believes “To The Stars” are filling a void in the content creation space. He characterises his efforts as a “science fiction Disney for adults”. He wants to write a historical fictional account of the UFO phenomenon and “our dealings with it.”

He said that while his Rock band was “unravelling in the press,” he was travelling to meet people from NASA, DOD and other agencies and he kept this process secret from his fellow band members. Then, he said stories about his meetings with “insiders” came out in the Music Press and elsewhere (e.g. an article in the Wall Street Journal - WSJ). He said he started to tell “the story of the millennia in his book *Sekret Machines*” and in one particular meeting, he “was put in his place” because of the enormity of the UFO subject. The book he had written apparently caused telephone “calls to be made” and the person he met said to him “you know things you shouldn’t know and I don’t

even know who the hell you are.” He says he was humbled by, and respectful to, the people he met and that he was an advocate of “men and women in uniform” (I am guessing he meant he was respectful of the people working for the military, police and emergency services). Interestingly, he mentioned his brother had a career in the Special Forces.

He said that following the WSJ article, he was contacted by other people (insiders, we might assume) and “a strategy was developed.” He said that we must first understand that “*the DoD has a culture of secrecy*” – not out of disdain or distrust for its citizens, but because it’s appropriate to “*protect the lives of its people, technologies and methods.*”

Here, I think he is saying that DoD people get special treatment and aren’t really going to tell you any secrets anyway – because they would then be at a strategic disadvantage. This basically means that in any environment where there is a military force working in secrecy, there won’t be any planned voluntary disclosures at all by them. He then said “*it’s not in their job description to help you and me understand the universe, past events or why certain actions were taken on the UFO phenomenon 70+ years ago – they were too busy actually dealing with it.*”

I think he is saying here that there *is* a cover up of the UFO phenomenon, but the people that are on this panel will *not* talk about it.

He then says he has worked for 2 years to construct a “missing mechanism” – one that can take the biggest, most controversial secret on earth and surround it with three ground-breaking strategies that will innovate, educate and “wildly entertain.” So, is “surrounding the secret” like “covering it up”? I thought disclosure involved breaking the cover that is over a secret, not putting something else around it? (It could be said that he is telling us he can only do “limited hangouts” with any information he might be given.)

This is how he characterises his “To the Stars Academy of Arts and Science” He said, truthfully, he wanted to define a future and not be victim to one.

He then mentions the difficulty of approaching a subject which could potentially change the world – considering it contains earth-changing technology, the need to understand a coming tidal wave of information and “the story of the millennia.” He said he wants to build a funding machine to “continuously attack those 3 things” and lists the categories of Science, Aerospace and Entertainment. He says “we have a plan to bring the unimaginable, the stuff of dreams to the world.”

TTSA aims to “communicate historic events and forward-thinking ideas through motion pictures, and that includes ongoing scientific discovery and building an exotic craft that includes an energy source that can revolutionise the world.”

He then talks about crossing an invisible boundary that “forces us to make the same mistakes over and over again” (he looks slightly less comfortable when he says this).

The Panel

He then mentions members of his team – Jim Semivan – a *career spy* and former Senior Intelligence Service member in the CIA’s directorate of operations. Semivan is a strategist with “the ability to help the ‘To the Stars’ Academy navigate all the many sensitivities involved either with government or with others who may eventually want what we have.”

DeLonge then introduces Dr Hal Puthoff as

*...a theoretical physicist and a program director for numerous CIA and DoD classified programmes. Dr Puthoff is the creator of the CIA’s own revolutionary **Psychic Spy programme - still used to this day** and his breakthrough science dealing with the engineering of space time is crucial to potentially understanding the technology observed.*

(Perhaps the statement about the present day and ongoing use of “psychic spies” is the only real disclosure of the whole presentation.) It is hardly surprising to see Puthoff’s name here – it seems very likely to me that Puthoff knows quite a bit about black programmes – and [he seems to appear wherever “fringe science” projects are started](#)⁷⁸³.

He then reports that Steve Justice will lead the aerospace division, now that he has retired as a Director of Advanced Systems at Lockheed Martin Skunkworks. TDL states that “to this day, Skunkworks is the Top Tier Aerospace Organisation for the development of advanced aircraft that meet *our urgent national security needs*.” This probably means we won’t be seeing any disclosures of any kind from Skunk Works. Perhaps we should therefore value, even more highly, what [Boyd Bushman told us](#)⁷⁸⁴.

DeLonge then introduces Luis Elizondo, who is also reported to have “just retired” as Director for the National Programme of Special Management Staff (but his agency is not stated, though I guess it was either CIA or NSA) and TDL says he will be creating/building partnerships with some very sensitive places to help protect some of the Technology that “To The Stars” will be building. He essentially says Luis Elizondo will “Protect us and protect technology to achieve the extraordinary...”

Chris Mellon is then introduced as the chairman of the “To The Stars” National Security Policy and Scientific Advisory Board – he has a long career at the DoD as Deputy Assistant Secretary of Defence for Intelligence and minority staff director of the senate intelligence committee. He says that Chris Mellon was involved in reviewing many of the US’s most “sensitive activities” over the course of his career.

Chris Mellon

In his discussion, he talked about combining science and entertainment in a single company. He discusses Sputnik (yes, really!) saying that because Sputnik was not kept a secret at the time, this triggered the development of the space race. He talks about learning through reading “stories” and rational inquiry. He notes how “we’ve adapted our story telling.” He mentions a UFO incident with an aircraft carrier – the USS Nimitz. He recounts the incident and says

that you can search for details using keywords “Nimitz UFO 2004 There I was.” Hence, this is not new information. The incident is still being discussed in the media a year later. Mellon suggests that congress should ask for a briefing, asking that if they don’t “How can they accurately assess *threats to our forces and our military requirements?*” Is this a way of saying that by scaring members of congress, more money could be earmarked for black programmes...?

He says “We are a corporation with a public purpose and we are all about combining the light of reason and passion of art to stimulate new thinking and discoveries.” Notice that he doesn’t talk about disclosing secret information.

Luis Elizondo

Elizondo reported that his work involving assessing “Advanced aerial threats – unidentified aerial technologies.” And he continues “It was in this position that I learned that the phenomena is indeed real.”

The rest of his discussion is essentially about logging UFO/UAP observations, using Phone apps and so forth, so that people can observe things in real time and log and network their observations too. (Will this mean an even quicker response time for black ops teams to come in when an incident happens? I doubt it, as it appears that Black Ops people have far better detection systems than the regular human senses... Maybe they use Psychic Spies...)

In his 2018 Lecture [Richard D Hall analysed one of Luis Elizondo’s interviews and concluded that he was deliberately misleading people with some of what he said.](#)⁷⁸⁵

Steve Justice

In his presentation, the former Director of Advanced Systems at Lockheed Martin said, “One of the things I wanna do is figure out what those technologies are in this observed vehicle and I want to build *that*. I wanna build something that absolutely stimulates the imagination. To the Stars Academy is structured to do just that.”

Completely absent here is any suggestion of captured or already constructed technology, such as that discussed in earlier chapters of this book.

The rest of his talk is about how he would like things to be in the future and he again reveals nothing about any secret research he was involved in or has knowledge of – he just talks mainly about how white-world technology has got better (which we all know about already.)

Promotional Video

[The live-stream included the showing of a fairly well-made and somewhat glitzy promo video](#)⁷⁸⁶. I noticed the video includes “one eye” and obelisk symbolism and it gives no information about what has already been achieved (in secret) - instead it, again, talks about doing things in the future, not about what was done in the past. This video features Hal Puthoff who says “We

know warp drive is not out of the question.” Jim Semivan says he wants to “get to the bottom of ESP and telepathy” even though they were investigated by the CIA over 40 years ago. Why doesn’t Semivan talk to Puthoff? [He would be able to find out about the projects which involved Uri Geller and Edgar Mitchell.](#)⁷⁸⁷

In the video Elizondo says “there are physics we don’t quite understand – it doesn’t mean they are not real.” This is misleading, as we know what happened on 9/11 involved a black programme of a developed and tested technology. Elizondo also says “The fact is, *we might not* necessarily be alone.” This is just a limited hangout. Saying “The fact is... we might...” is meaningless anyway. He should know craft have crashed previously and been recovered - as have bodies – as already discussed in this book (and many, many others!).

There is a very brief clip of a few frames from the [TR3B CGI hoax video](#)⁷⁸⁸ (there are several different postings of this video, said to be in different places.) The rest of the video is just “feel-good” superficial material, again mentioning “unique story-telling experiences.” The video shows a military plane in a hanger, a satellite, a chemical rocket and a model plane.

Following the video TDL made various other statements, including that they want to launch satellites into space with lasers (another [20-30-year-old idea](#)⁷⁸⁹). There is no real talk of disclosing secrets and ending black programmes – [it is essentially all just a glossy marketing exercise.](#)⁷⁹⁰

Further Comments and Analysis

A few things stand out from this presentation. The phrase/word “storytelling” is used quite a few times and reference is made to “movies” and “entertainment.” It’s almost as if truly thought-provoking films like “Close Encounters of the Third Kind” and Paul Davids’ “Roswell” TV Movie from 1994 are ignored. Even films like “The Matrix” could have been mentioned. The use of a lighthouse in Chris Mellon’s presentation reminded me of the Masonic Torch symbol/motif.

It appears this TTSA company is essentially CIA-run and perhaps just another honeypot to attract punters and maybe even some whistle-blowers. This seems to be essentially what Steven Greer’s Disclosure Project, as is discussed elsewhere in this book, has now become.

At the end of the presentation, TDL encouraged people to go to his website and “Join us and own a piece of this and go and invest on the website...” However, if you are a smart investor, wouldn’t you be asking “What am I investing in?” In the presentation, only general ideas are specified and no *specific* projects are discussed. One “mock up” prototype aircraft (which doesn’t look like a flying saucer, nor does it look like a conventional aircraft) is shown. Another reference is to the idea of using a 30-40-year-old technology – to use lasers to launch a craft. So, if you invest money, will they tell you secrets?

TDL suggests that “these guys went out on a limb” But did they? What have they disclosed? I want to see every single member of this TTSA panel read and comment publicly, accurately and honestly on the contents of [Dr Judy Wood](#)²³⁰'s book “[Where did the Towers Go?](#)²³¹” When they have acknowledged the truths therein, then I will consider listening to them.

In the next section of this book, we will discuss evidence of another phenomenon which is often connected with UFOs/ETs and aliens, although once this phenomenon has been studied, these apparent connections don't seem to be as strong. However, there is at least one group or agency which has involvement in both phenomena.

Part II

A Mystery in the Fields

25. Introduction and Overview of Crop Formations

In this section, by looking at the available evidence, we will attempt to gain a better understanding of the “Crop Circle” phenomenon. It is more accurate to use the term “Crop Formation” or “Crop Glyph,” rather than “Crop Circle” – as there are many “Crop Circles” which aren’t actually circles!

This section is largely based on a presentation I compiled in about 2009. Most of the quotes I use come from the period between about 2005 and 2010. I won’t be covering the full breadth of the phenomenon – there are other books the reader can access, such as [Circular Evidence: A Detailed Investigation of the Flattened Swirled Crops \(1990\)](#) by Colin Andrews and Pat Delgado⁷⁹¹ and [Freddy Silva’s Secrets In The Fields: The Science And Mysticism Of Crop Circles \(2013\)](#)⁷⁹². Many superb photographs have been taken by [Lucy Pringle](#)⁷⁹³ and [Steve Alexander](#)⁷⁹⁴ and others. Also, in the past, I was asked why I hadn’t really discussed some of the mathematical elements that seem to be present in many formations. However, [the person that asked me this describes himself as a “flamboyant story teller!”](#)⁷⁹⁵

My understanding of the formations, though, is probably rather different to most other authors and in this set of chapters, I will attempt to explain why, based on my own observations and assessment of the research of others mentioned above. Some readers will not be too surprised to see that my approach is quite similar to that of Richard D Hall. As well as looking at basic aspects of physical evidence, it is important to consider the context of this evidence and also study and consider the parties that have expressed an interest in the phenomenon and we should also consider the way that that interest has been expressed.

Also, I can openly state that I have never visited a Crop Formation, neither have I sat or stood inside one. However, I am not at all sceptical of the reality of non-mechanically created formations, but I do question some of the statements made by some researchers, who may be “missing out” some important considerations.

A History of Crop Formations

Some of this section is derived from perhaps the most scientifically oriented [Crop Formation website – BLT research](#)⁷⁹⁶. We will discuss the research from this site later.

Pre - 1970



One of the earliest descriptions accompanies some drawings of two U.K. Crop Formations described in “A Natural History of Staffordshire (1686) by Prof. Robert Plot. Plot examined multiple such formations and states that the soils

“under all of them were much looser and dryer than ordinary, and the parts interspersed with a white hoar... much like

that in mouldy bread, of a musty rancid smell, but to the tast[e] insipid.”



This Crop Formation, from the same era (17th Century), also from the “A Natural History of Staffordshire” publication, occurred in St. Gile’s fields at University College. The cloud and trumpet-like diagram illustrates Plot’s hypothesis that Crop Formations...

“must needs be the effects of Lightning, exploded from the Clouds” ... in this case, the clouds “breaking first in a quadrangular, and after in a wider circular forme.”



A later story comes from 1678. A pamphlet tells of a farmer who, refusing to pay the price demanded by a labourer to mow his field, swore that he would rather that the Devil mowed it instead. According to the pamphlet, that night his field appeared to be in flame.⁷⁹⁷ The next morning, the field was found to be perfectly mowed -

supernaturally perfect, in fact.

The Mowing - Devil :

Or, Strange NEWS out of

Hartford - shire.

Being a True Relation of a Farmer, who Bargaining with a Poor Mower, about the Cutting down Three Half Acres of Oats, upon the Mower's asking too much, the Farmer swore, That the Devil should Mow it, rather than He. And to it fell out, that that very Night, the Crop of Oats grew so fit, had been all of a Flame, but next Morning appeared to neatly Mow'd by the Devil, or some Infernal Spirit, that so Mortal Man was able to do the like. Also, How the said Oats lay now in the Field, and the Owner was not Power to fetch them away.



Years later, in July 1880 the prestigious science journal Nature (Vol. 22, pp. 290-291) published a letter from British spectroscopist J. Rand Capron, describing his discovery and examination of several flattened circular areas of wheat on a farm in southern England. He described areas of crop

“forming ... circular spots [with] a few standing stalks as a centre, some prostrate stalks with their heads arranged pretty evenly in a direction forming a circle round the centre, and outside these a circular wall of stalks which [have] not suffered.”

Capron then suggested that these had been formed by “some cyclonic wind action.” He added a sketch of the “most perfect” of these

circles but this was not published.

There are reports of circles in the 1900s, as noted on BLT's site:

Modern farmers and land-owners, in cases where the land has been in the family for generations, regularly recount that their fathers, grandfathers, and in some cases great-grandfathers, did find Crop Circles in their fields from time to time—often in the same fields now affected by the phenomenon. A few photographs also exist of English Crop Circles which occurred in the early 1900s. Many of these Crop Circles seem to have been simple circles, or circles with rings, but some of them are reported to have been more complex in design.

These anecdotal accounts have been obtained from farmers in several different countries in Western Europe and in North America and seem to rule out the idea that modern technology is responsible.

In the 1990s, some aerial photos started to emerge, suggesting there were some formations seen in the 1940s and 1950s. [Later research by Greg Jefferys using Google's Historical Maps](#)⁷⁹⁸ also seemed to reveal [some Crop Circles in the years prior to the 1970s – for example, in 1945.](#)⁷⁹⁹ There was an archive of 1945 aerial images of parts of the UK which was available through Google Earth for some period of time (it isn't obviously available now, but may be hidden away somewhere...)



Greg Jefferys notes:

“This Crop Circle from Great Bookham (above), is a classic Crop Circle, even showing a suggestion of that little vertical twisted tuft in the center of the circle that has been photographed so many times in modern Crop Circles. From the shadow on the hedge the photograph appears to have been taken about 11.30 am and the field of grain is not mature.

Saucer “Nests”

As might be implied by the title and content of this book, it is sometimes assumed there is a strong link between the topics of Crop Circles and UFOs/aliens. However, when all the evidence is studied, it seems that the link is not particularly strong (we will discuss this area more later in this book). In the 1960s, at least one UFO sighting was associated with a type of Crop Circle.



1966 – Tully Saucer Nest⁸⁰⁰ of swirled reeds, floating in a lagoon.

In Tully, Australia, at 9:00 am on 19 January 1966, George Pedley, a 28-year-old banana farmer was driving a tractor near a place called Horseshoe Lagoon which was on the property of Albert Pennisi, in the tropical far north of Queensland. At a distance of about 25 yards from the lagoon, he heard a hissing sound, louder than the noise of the tractor – and the tractor seemed to be misfiring. As he tried to work out where the sound was coming from, a grey saucer-shaped object, about 25 feet in diameter and 9 feet thick in the centre, rose from the lagoon – to a height of about 30 feet, tilted a little to one side, and then shot off towards the south-west at phenomenal speed.

Pedley then jumped from the tractor and ran to the lagoon and saw a large circular area of rotating water – and the reeds had been removed there.

Later that morning he went back to the lagoon and found “a swirled mass” of reeds that had, by then, floated to the surface. The reeds had been swirled in an anticlockwise manner, and were still green but by mid-afternoon when he returned to the lagoon with Albert Pennisi, the reeds had turned brown.

The case was picked up by local media, police and the RAAF and others. Some of the reeds were sent for testing at the Physics Dept. of the University of Queensland in Brisbane. Further investigations near the site revealed other smaller “nests” and even a set of possible footprints which may have been an indication that occupants left the craft and walked away. More details about this case are included in a [2016 YouTube video](#).⁸⁰¹

The 1970s and 1980s

I haven't come across many notable Crop Formation photos or reports from the 1970s, although there are allegedly photographs from circles in

Switzerland taken in 1975 and 1976. A few years earlier, [Bryce Bond](#) and [Arthur Shuttlewood](#) were the first “modern” Crop Circle witnesses in [Warminster, on the night of August 12, 1972](#)⁸⁰²: Bryce Bond is quoted in Shuttlewood’s 1977 “Flying Saucerers” book:

Suddenly I heard a noise - like something crushing the wheat down ... and there, before my eyes, a large depression was being formed. The wheat was being crushed down in a counter clockwise position. It too was shaped like a triangle and measured about twenty feet from point to point ... Speaking of the field, Arthur pointed out some landing impressions in the section fronting the farm barn: a circle about thirty feet in circumference, with another depression spotted, but this one in a long cigar shape. All the depressions, recently made and noticed, were in a counter clockwise fashion.

It seems the circles began to proliferate in the UK in the 1980s, with formations (mostly circles) reported in Leicestershire, Hampshire, Wiltshire and other counties.⁸⁰³ Below, I have included a photo from [Colin Andrews’ archive](#)⁸⁰⁴, with his caption, in which he notes a characteristic “swirling” of the laid-down crop:

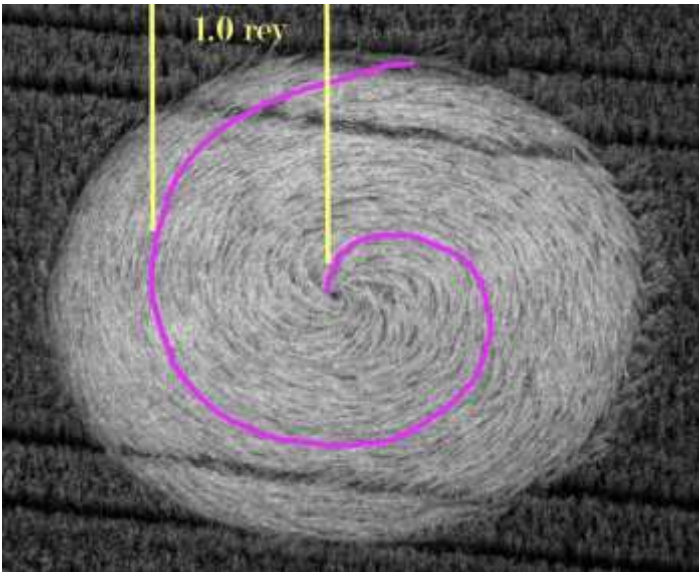

31st July, 1985 at Longstock, Hampshire in England. One of five found together by Busty Taylor, each with similar signature. Copyright: Michael Green, 1985. Annotation by Colin Andrews

Andrews himself took a photo of a similar circle in 1989:



5th August, 1989 at Winterbourne Stoke, near Stonehenge, England with the signature almost radial. Copyright: Colin Andrews 1989.

Andrew Johnson Photographs some Circles!

During a visit to see my elder brother in Wiltshire in July or August 1987, we were walking near Silbury Hill. Two people can be seen in the central circle:



When I took this photo in 1987, I had no idea what I would later learn...

The 1990s – Circles Become Pictograms...

It was in this year that [Lucy Pringle](#) began documenting the formations in detail – from the air using a microlight aircraft.⁸⁰⁵ The montage below is from her photos.

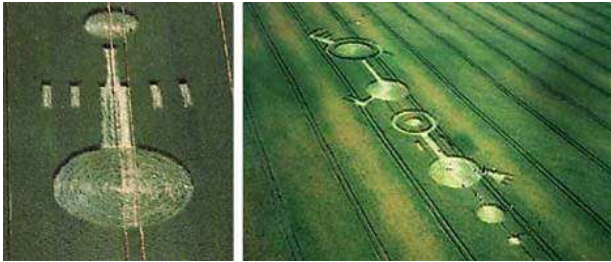

Lucy Pringle's July 1990 photos of formations in Crawley Downs, Hamps (left) and Alton Barnes, Wilts (right)

On his website, [Freddy Silva](#) has an account⁸⁰⁶ of a particularly interesting formation shown in the right-hand photo.

On the night of July 10, 1990, the inhabitants of the village of Alton Barnes heard a peculiar buzzing sound which caused all dogs in the village to bark incessantly throughout the night. As the dawn light bathed the Vale of Pewsey, none of the farmers' cars would start. And as they approached their fields no one could believe their eyes- a 603 ft pictogram lay majestically in the wheat.

The Alton Barnes formation was famously used on the cover of a 1990 Led Zeppelin album (but don't forget to do some research on the occultist [Jimmie Page](#), who bought [Aleister Crowley's house](#)⁸⁰⁷, which burned down in 2015.⁸⁰⁸ Page had sold the property some years earlier, however.)

Silva and others argue that some of these symbols have cultural significance. On the page referenced above he states:

It was later discovered that the 'trident' design in this and other formations of the year bore a close resemblance to traditional and esoteric symbols associated with transformation. How appropriate this explanation becomes in light of the circumstances, for here at last was a Crop Circle that single-handedly transformed thousands of people of all races practically overnight.

We will consider this concept more deeply later. We will also study the increasing interest from the media and the military – which Colin Andrews has written and spoken about.

Crop Circles “Growing!”

On the BLT research website, several cases of Crop Formations growing are noted.⁷⁹⁶ Nancy Talbot writes:

In a number of cases every summer geometric formations with clean, crisp edges have been discovered in fields which subsequently—often within one or two days—show evidence of having been re-visited by the circle-making energy system.

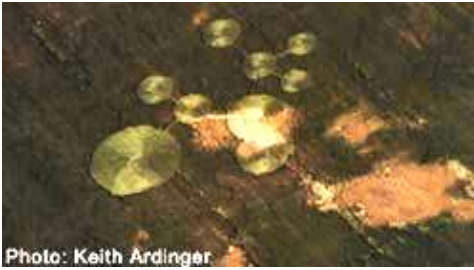

When this multi-circle formation in Washington state (left) was first photographed on June 21, 1998 all of the circles had crisp, distinct edges—and there were only a few patches of randomly-downed crop in the rest of the field.



When re-photographed on July 8th patches of randomly-downed crop covered the field, damaging the edges of many of the original circles.

This is certainly a part of the phenomenon which isn't talked about so frequently.

Early 2000s – Complex Formations

Pringle's database/library of photographs has become an invaluable resource, as has that of other researchers like Steve Alexander and they clearly demonstrate a fairly rapid increase in the complexity of the designs throughout the 1990s and 2000s. Two incredible examples are shown below:



Milk Hill, 14 Aug 2001⁸⁰⁹



Milk Hill (Alton Barnes), 21 Jun 2009⁸¹⁰

In the left-hand formation from 2001, which was about 1500 feet from the edge to edge, consider the total number of “component parts.” This was truly incredible, compared to earlier formations.

At this point, we can note that development of the personal computer in the 1980s and 1990s also parallels the development in the complexity of Crop Circles. Also, we saw some Crop Formations which had fractal designs – in the form of a [Julia Set](#)⁸¹¹ (1996) and a [Mandelbrot Set](#) (1991)⁸¹² – these were

common things to see on home computer screens (BBC Micro, Amiga etc) at that time. Later, we will explore a possible connection between these factors.

Rather than now showing a gallery of Crop Circle images, we will look at particular examples and also several areas of research into aspects of the circles which reveal certain important patterns (no pun intended).

UK – Yearly Crop Circle Counts

In updating my “Crop Circles” presentation in 2016, on which this section of the book is based, I decided to try and find or work out how many formations had been reported each year. This wasn’t that easy, as only one site had detailed data, but it was just a set of collated reports, not an online database. However, I ended up using counts from 4 different sources:

- The Crop Circle Centre
- Crop Circles Database
- Crop Circle Research.com
- Lucy Pringle

The right-hand column in the table below shows the World Count total from the Crop Circle Centre website.

Depending on which counts you use, from particular countries or locations, the “peak” occurs in different years. A clear peak seems to be shown in 1992, with smaller ones in 1999 and 2003. Some researchers have tried to correlate these peaks with things like sunspot activity, although as you can probably agree, due to the nature of this phenomenon, it is not easy to know what proportion of formations are never reported or not discovered. Hence, any counts we use may not be all that accurate. Also, are the high counts in the 1990s only representative of the “peak in the public interest” in the phenomenon in those years?

Crop Circle Count Graphs

This graph, for example, clearly shows a peak in the UK in 1999:

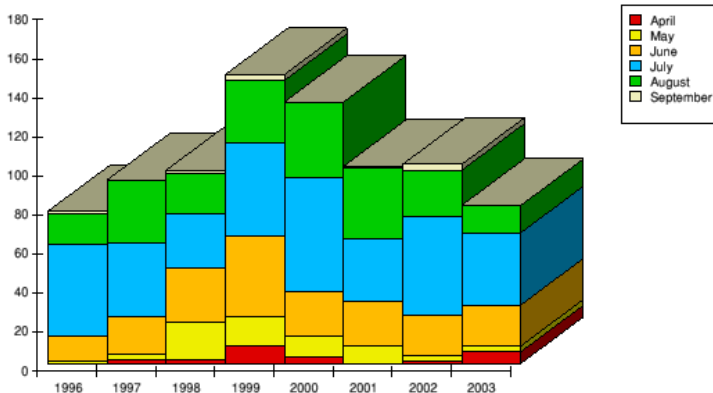

Graph from Crop Circle Research Dot Com⁸¹³

Crop Circle Counts by Year

	CCC ⁸¹⁴	CCDB ⁸¹⁵	CCR ⁸¹³	Lucy	CCC
Year					World
1990	166			3	249
1991	176			3	254
1992	257			3	312
1993	155			4	218
1994	212	18		9	277
1995	168	22		17	221
1996	148	13	78	19	294
1997	133	13	94	37	247
1998	126	23	99	66	277
1999	170	40	148	43	270
2000	150	41	134	57	287
2001	114	33	101	50	224
2002	114	29	102	39	259
2003	92	30	81	41	275
2004	80	23		42	243
2005	80	37		43	221
2006	57	18		23	185
2007	58	49		41	171
2008	85	46		46	177
2009	94	66		59	153
2010	71	42		33	144
2011	71	34		34	125
2012	77	42		36	139
2013	42	27		22	95
2014	51	29		20	104
2015	38	25			87
2016	47	43			66

Crop Circle Counts by Year

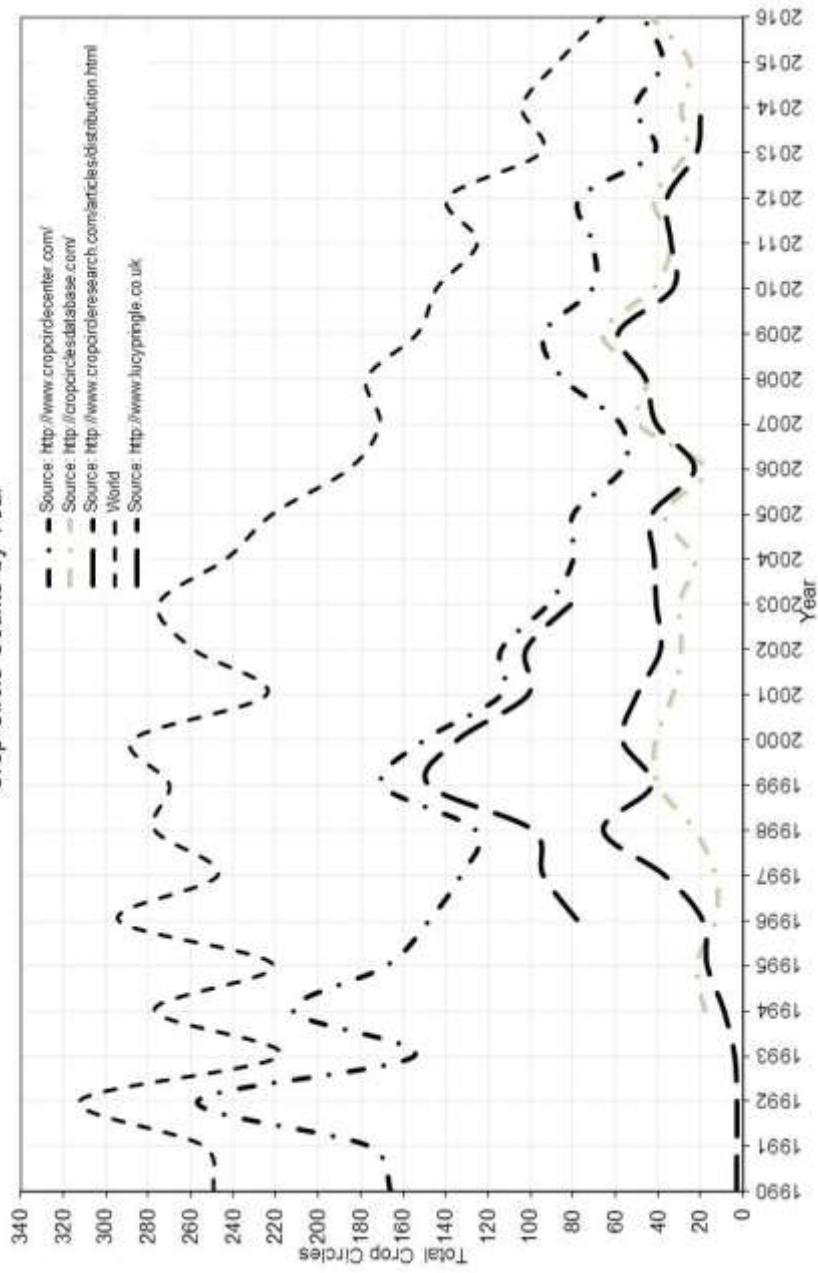

Graph generated in late 2016 from various sources (see table above) by Andrew Johnson

Natural “Crop” Circles and Formations

Before we dig deeper into the phenomenon, we will briefly cover some natural phenomena which some have said are relevant to the Crop Formations.

Fairy Rings



Fairy Rings on golf green.
Courtesy Joseph Krausz, TAEX, 1996.



A [fairy ring or fairy circle](#)⁸¹⁷, or a pixie ring, occurs naturally – it being the growth of a ring or arc of mushrooms. Such rings may grow to be 10 metres in diameter, becoming stable features as the fungus grows down towards food sources in the soil. Even if no mushrooms are seen, the fungus may still be present underground, causing a withering of the grass directly above.

In English folklore, Fairy Rings got their name from the stories of pixies or fairies dancing around in a circle, flattening the grass beneath their feet. Similarly, the “älvdanser” in Scandinavian folk tales, were said to be the results of “elf dances.”

Non-Geometric Crop Flattening

This is a factor which should always be considered and is described [thus on the BLT research website](#):⁷⁹⁶

Non-Geometric Crop Formations: ... anomalous plant changes documented in “geometric” Crop Formations (those in which a recognizable design is apparent) are also found in many cases of non-geometrically flattened crop. Called “lodging” by many farmers, and thought by them to be the result of intense weather systems impinging upon plants already weakened by over-fertilization (if too much nitrogen is applied to the growing crop, the seed-heads grow larger and weigh more, thus making the plant-stalk more susceptible to wind and rain).

Testing of quite a few of these non-geometrically flattened impressions (particularly when they are found in vicinities where geometric formations occur regularly) has, in a number of cases revealed the same plant abnormalities found in “geometric” events—and to a greater degree in most instances.



Laboratory tests on plants taken from non-geometrically downed areas like these, in many different countries, often reveal the same changes found in plants from Crop Circles of more geometric” design.

The BLT site notes that natural crop flattening and that seen in geometric formations does overlap:

Patches of randomly-downed crop are often seen in conjunction with, or overlying, recognizable designs in the fields.

We will discuss the plant and other associated changes later.

26. Some Researchers and Some Research

In this section, I will discuss some of the researchers involved in the investigation of Crop Formations. There are many that I have omitted in this first section. I will reference several other researchers in later chapters, but not give as much detail about their backgrounds.

I thank them all for their research and contribution to the understanding of this phenomenon.

Colin Andrews

Andrews worked as an electrical engineer by profession and as a former senior officer in British regional Government. As a result of his persistence, the subject was raised in the UK House of Commons.



From his website, we read⁸¹⁸:

Colin Andrews is an electrical engineer by profession, is the man who coined the term 'Crop Circle'. Among his many accomplishments: he started the first research organization, Circles Phenomenon Research (CPR); designed high-tech surveillance operations attempting to film a circle being made; and advised Prime Minister Margaret Thatcher's cabinet and Queen Elizabeth on the mysterious phenomenon. He compiled the largest

database in the world on the subject. Colin has written numerous books including the classic Circular Evidence (1989) with co-author Pat Delgado, chosen by the Queen for her prestigious Summer Reading List. He is frequently highlighted in documentaries on the subject and was a consultant with the Mel Gibson movie "Signs." His most recent book, co-written with Synthia is 'On the Edge of Reality' which was preceded by "The Complete Idiots Guide to 2012" and "The Complete Idiots Guide to the Akashic Record" also with his wife, Dr Synthia Andrews. He is currently making his archives available to the public in books such as "Government Circles," "The Andrews Catalogue" and "The Assessment."

Andrews is not over-stating his contributions to the research and his website is a compendious and very important resource for anyone researching this topic and others that are closely related. I will quote him frequently in the following text. Also, on his "biography" page, Andrews references his use of dowsing in Crop Circle research, which is interesting and useful, but rarely 100% reliable. However, we will reference its use later.

We can note in what he wrote above, his movement into what might loosely be called the "New Age" scene – away from the nuts and bolts of engineering. (Readers of my earlier book "Finding the Secret Space Programme"⁴²) may remember my criticism of Andrews for not accepting that Edgar Mitchell was *not* a hero of the New Age movement – rather, he was an asset who was working for the CIA. Andrews, like so many in the "truth movement," should study the evidence properly and then accept that Mitchell lied about his moon landing experiences and threatened people who were trying to reveal certain truths.)

Andrews is seemingly an honest, decent and ethical man – and should not be blinded by “New Age” opinions and thinking. Would it be inappropriate of me to ask if he has been subjected to a bit too much government or intelligence service influence or control? Perhaps by the time you’ve finished reading this book, you will have knowledge which might help you to answer that question.

Rockefeller Funding

Andrews did receive some of this and was asked to keep this information confidential, [as he states in a 2015 article on his website](#)⁸¹⁹:

In 1999, I received a grant from Laurence Rockefeller for two Crop Circle projects: to look at hoaxing and to conduct research into magnetic anomalies found in Crop Circles. I was told to keep the source of funding in confidence. I asked who else might be doing interesting research, but was not told who else was being funded.

Colin Andrews, Dr Steven Greer and Cancer

In chapter 23, we took a detailed and critical look at a key figure in the UFO/Disclosure field – Dr Steven Greer. It is no secret that Greer and Andrews worked together at certain times – and both of them received Rockefeller funding. [On Andrews’ website, on a page about the testimony of the Computer Specialist William Pawelec](#)⁸²⁰ (which we also covered in chapter 23), Andrews notes that four people – of which he was one – got the same type of cancer at about the same time. Two of them died – Sheri Adamiak and congressman Steven Schiff. Andrews’ cancer was successfully treated at a Yale Medical Centre. I could not find details of how Andrews was treated - and neither have I asked him about that). Perhaps it is therefore unreasonable of me to suggest, as part of his cancer treatment, that Andrews was “influenced” to make sure he would not reveal certain truths about people he has met and praised – i.e. (again) alleged moonwalker and CIA asset [Edgar Mitchell](#)⁸²¹ and [Dr Steven Greer](#)⁸²² – both of whom I have written about at length elsewhere and in this book, carefully documenting where they have not been truthful.

BLT Research and Plasma Energy

The “BLT” stands for the surnames of the three main people behind the site – [John A Burke](#),⁸²³ [W.C. Levensgood](#)⁸²⁴ and Nancy Talbot. Nancy has compiled a very important resource for us all on her site. Levensgood was, essentially, the Scientist in the team – having completed B.Sc. in Physics and Mathematics in 1957 an M.A. in Bioscience in 1961 and an M.Sc. in Biophysics in 1970. Levensgood had his own Lab. Burke and Talbot had other experience – [Talbot as a music producer and Burke as both a businessman and someone who had a keen interest in geomagnetism and electromagnetic theory](#).⁸²⁵ We must remember therefore that BLT are just one of several “unofficial” teams of researchers.



John A Burke (1951-2010)



W.C. Levenson (1925 – 2013)



Nancy Talbot

There are a number of papers by W.C. Levenson posted on the BLT research website⁸²⁶. Whilst I note, below, Colin Andrews' criticisms of some of Levenson's work, I don't want to "throw that baby out with the bath water" (again). You will later see that other researchers showed similar results/ observations to those of Levenson, regarding plant stem effects within Crop Formations etc. A published paper entitled "Dispersion Of Energies In Worldwide Crop Formations"⁸²⁷ by Levenson and Talbot has the following abstract:

The findings reported here lend further support to a decade of research which suggests that over 95% of worldwide Crop Formations involve organized ion plasma vortices that deliver lower atmosphere energy components of sufficient magnitude to produce significant bending, expansion and the formation of unique expulsion cavities in plant stem pulvini, as well as significant changes in seedling development. Here we demonstrate that, in a number of formations, quantitative node alterations can be directly related to fundamental concepts of electromagnetic energy absorption through the atmosphere. Also, in a detailed field study of simulated Crop Formations, we show that overfertilization or gravitropism cannot account for observed physiological alterations. In addition, we demonstrate that details of flattened, intertwined crop patterns can be described by the application of fluid dynamic principles governing the interaction of rectilinearly moving vortex pairs.

This paper is indicative of BLT's focus – which was more about trying to understand and explain the process or mechanism of formation of the Crop Circles rather than explaining their geometric or other designs.

Talbot was interviewed for a 2004 discovery Channel Documentary,⁸²⁸ which like most documentaries, was not balanced and focused on hoaxing⁸²⁹. In the documentary, however, Talbot stated what most serious researchers have considered:

I know that there is something which will enlarge our concept of reality by studying this... We will learn more than we know now about what we call reality...

My personal experiences have suggested the possibility that this energy system is conscious ... has a consciousness, somehow or other interacts with consciousness...

As these results are made public, I hope they'll inspire more scientists and eventually we have enough people asking enough questions maybe we'll have an answer to what this is. I hope so. That's our purpose anyhow.

I strongly identify with Nancy Talbot's statements here – and it is likely most other researchers would too. However, as with other fields of alternative research where different individuals and groups are operating, disagreements arise, with accusations of “bad practice” or “erroneous conclusions” and so forth. Colin Andrews, who has perhaps done the most work in the field of [Crop Circles](#), documented a number of problems with the BLT research and felt that Nancy Talbot was not being totally honest about certain results that Levensgood had claimed, when he was sent samples gathered by some of Andrews' research associates, from two separate areas of the same field.⁸¹⁹ In one case, one sample was from a circle and one was from a naturally flattened area, but according to Andrews, the results Levensgood produced did not appropriately distinguish between the two. Andrews also points out (as others have) that there were issues with Levensgood's credentials where he seemed to suggest he had a PhD when he did not. Andrews essentially stated that BLT had “fudged” their studies to support pre-determined conclusions regarding the energies involved in the creation of Crop Formations. However, most researchers could be accused of similar actions and, indeed, it could be said that Andrews himself has certain pre-determined conclusions (and perhaps so do I!)

Before we get too drawn into all that, let us remember that there is important data on both the BLT website *and* Colin Andrews' website. (We will cover some more of Andrews' own research soon.)

I would like now to consider some of the interesting writings of [John Burke](#). He said in a 1998 article he wrote called “[The Physics of Crop Formations](#)”⁸²⁰ where he discusses the possible mechanism behind some of the formations:

Plasma was first hypothesized as the cause of Crop Formations by English meteorologist Terence Meaden. He suggested the plasma was in the form of a vortex produced meteorologically. Unfortunately Crop Formations did not seem overly dependent on any set of weather conditions, and this model did not explain non-circular formations.

Burke then suggests how an ionospheric, lower energy plasma could be involved. He mentions the [lightening phenomenon, seen high in the atmosphere, known as “sprites”](#)⁸³¹. He notes:

...there are frequent exchanges of electric cargo between the ionosphere and a storm 90% of the way to the earth's surface. We believe that sometimes the exchange may cover the other 10% of the distance as well, and actually reach the ground.

Something similar is known to happen every night everywhere when plasma penetrates part-way down (causing perturbations in the geomagnetic field). Normally these attempted penetrations are bounced back the way they

came by the reflective layers of the ionosphere—the same reflective layers which AM radio waves bounce off to communicate over the horizon. At night these layers weaken and rise (which is why you can get AM radio reception over much greater distances late at night).

They are weakest in the predawn hours, when most Crop Formations occur. The ability of plasma to penetrate these reflective layers is directly proportional to its “vorticity” (i.e. the tighter and more rapidly spinning the plasma cloud, the further it can penetrate toward the ground). The “magnetic pinch” effect insures that as such a plasmoid descends toward the earth’s surface, it shrinks in size and spins faster (much like spinning figure-skaters accelerate by pulling in their arms).

Burke had a particular interest in the apparent energy systems associated with Crop Formations and he often related this to “earth energies” that seem to be associated with Stone Circles and similar megalithic sites. With this area of research in mind, [he and his colleague Kaj Halberg published an interesting book in 2005 called “Seed of Knowledge, Stone of Plenty.”](#)⁸³²

Rockefeller Funding

According to [BLT research’s Website](#)⁸²⁵, they, too received funding from Laurance Rockefeller:

In 1999 an opportunity to carry out some new research presented itself when New York philanthropist Laurance S. Rockefeller offered funding. In order to meet Mr. Rockefeller’s requirements Ms. Talbott sought and was granted non-profit, tax-exempt status, and BLT Research Team Inc. was created, with Ms. Talbott as President.

Dr Terence Meaden and Plasma Vortices

Burke’s article leads us on to a discussion of a possible mechanism which could explain some of the simpler Crop Formations. Burke referenced the [British \(among other disciplines\) Physicist Dr G Terence Meaden – an Oxford University don](#)⁸³³, who favoured a “plasma vortex” explanation for Crop Circles⁸³⁴. Meaden, however, was “caught out” in a 1991 Channel 4 “Equinox” documentary about the circles suggesting that a planked-formation had been created by plasma energy.⁸³⁵ His comments following the revelation that he had suggested a “hoaxed” (planked) formation was “genuine” (i.e. made by plasma energy) were as follows:

I have to admit that some people, at least if they are scientifically trained, are capable of perpetrating at least one hoax. That does not, however, negate all the positive evidence, which has been gathered over the last 10 years in favour of “genuine” circles.

When a scientific theory is complete, then it would be possible to distinguish between hoaxed circles and genuine circles, but we are not yet quite at that stage. The theory is undergoing development and modification according to the incoming data.

It appears that much of the BLT research shown on their website tends to support Meaden’s ideas – that some type of Plasma and/or Earth-induced energy causes the formations to appear – and this same energy causes changes

in the plants. I am in complete agreement that some (“non-stomping” and “non-planking”) energy is definitely involved in many formations and we will discuss this in later sections. For now, let us consider some more evidence and ideas relating to Meaden’s theory. Please note, the images and research below are not Terence Meaden’s - they come from a [booklet called “Crop Circles: The Final Solution”](#) (referred to as “CCTFS” below), compiled in 1991 by the late Derby Based Researcher Omar Fowler⁸³⁶, with contributions from Paul Foster and Jeff Whitemar (PRA). The contents of this booklet were posted on Fowler’s website in about 2004, though this is now only accessible through the “Internet Archive” link, referenced above.

EMF Ground Waves and Plasma

The CCTFS booklet documents some measurements taken in Husbands Bosworth, Leicestershire, UK where a formation appeared on a hilltop for the fourth consecutive year around 3rd July 1992.

Here a “Microdet” - an instrument capable of detecting a wide band of radiation between 20Hz to 12 GHz, was used and the “Microdet” detected a “High Frequency (HF) blanket of radiation” on the hill top, but the source could not be identified at the time. Later measurements showed this field had disappeared. A similar measurement was made at Mansfield Woodhouse (Nottinghamshire, UK), following the appearance of three circles on 1st August 1992. Once again, the instrument detected a HF energy field in the immediate area, although the source of the emission could not be located. The CCTFS authors stated:

Using a “Microdet” meter, readings were taken, which showed an Electromagnetic “field” layer between about 6’ and 12’ above ground level (top/bottom of hill)

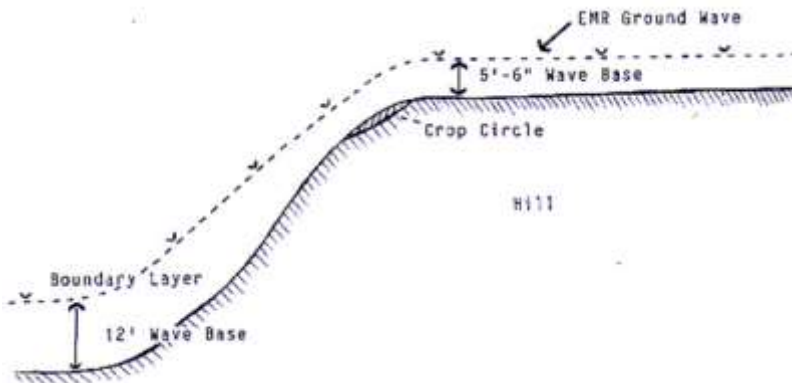

Further study was undertaken using an ionisation meter and the authors of the CCTFS booklet considered that an “existing ionisation charge, played a major part in the energy concentration formed in the Crop Circle area.” They state:

It appears that early dawn (approx. 4am) is likely to be the time that the phenomenon will manifest itself.

*Sampling instruments showed that under optimum conditions, a strong negative ion charge was likely to form over a wheat field in the early hours of the morning. This was particularly noticed in damp conditions, when the negative ion charge increased at ground level. This is probably due to the fact that each droplet of moisture carries a negative charge. *Reddish points of light have been reported dancing over wheat crops in the early hours (Husbands Bosworth Leics. 1992).(See wheat head diagram below)*

The CCTFS authors include an interesting diagram suggesting how an electrostatic field could form around the head of a stem of wheat:

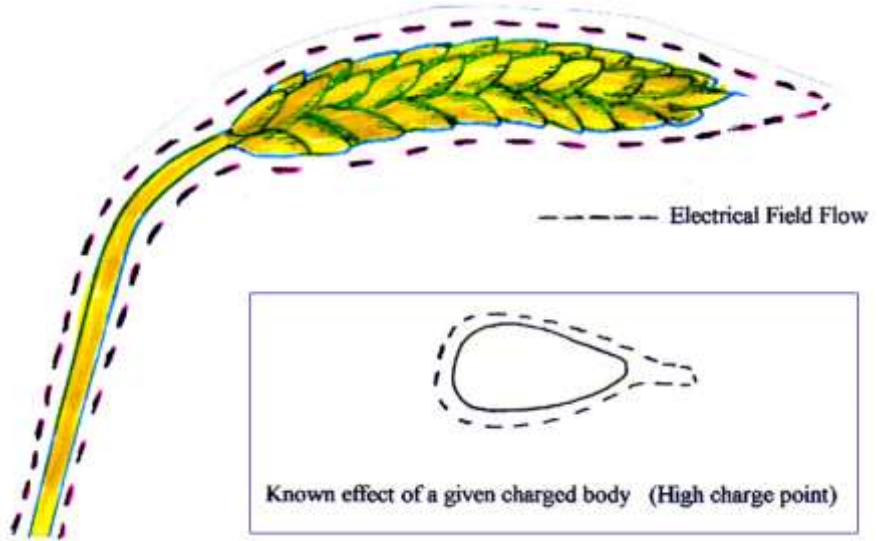

Perhaps the wheat head could build up a charge of static electricity in dry conditions. It's not difficult to imagine that when blowing continually in the breeze, a sizeable voltage could build up (think of stroking a cat, taking a pullover off etc).

Some years after the publication of this PRA booklet, Omar Fowler wrote a short piece in his November/December 1999 OVNI journal. Omar gave a talk to the Derbyshire [Ecclesbourne Farmers Discussion Society](#)⁸³⁷, on 5th October 1999 at the 'Cross Keys' public house at Turnditch, Derbs, in which he included some information about Crop Formations. Omar reported that, during his talk, one of the farmers remarked "Oh -you would be interested in the 'Corn Ripening Lightning' then." Other farmers apparently agreed that this was an observed phenomenon. When the corn is about to ripen, a static charge builds up over the cornfield, resulting in a white flash of light ("Corn Ripening Lightning"). We can obviously ask the question related to how any charge build up might vary with different crops – such as wheat, corn, barley etc. (Although, I have not been able to find references to similar phenomena observed elsewhere.)

The CCTFS authors then include a discussion of how the charge that has built up in the crop may then interact with conditions created by the solar wind which would then trigger formations.

At a point just before dawn, the Earth's energies are at their maximum level. The highest charges are being formed along the Earth's terminator point where particle interaction, magnetic interaction, chemical effects and electrostatic effects are all taking place. All these forces combining to give a massive "kick" of high energy through the atmosphere.

Although they don't name Terence Meaden, they include a diagram which seems to illustrate the same things Meaden spoke of:

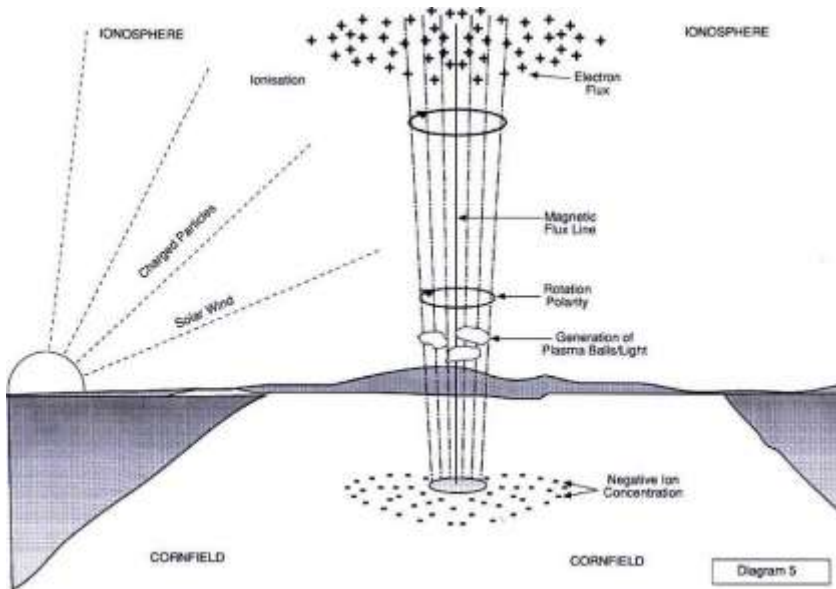

Their description continues:

Action of electromagnetic lines of force results in particle interaction, causing ionisation in the upper atmosphere. The electrostatic/electromagnetic effect of the phenomenon can result in photons being given off, this may appear in the form of glowing balls of light or even a column of light.

When reaching the earth, the energy field is likely to produce ground currents in the Crop Circle area and one would expect to find anomalies in any soil samples taken from the site. The effect of (DC) ground currents would be likely to induce magnetic and chemical changes, although there may be some variation, depending upon the type of soil in the area.

Of course, as with Meaden's theory, there is no discussion of how geometric designs would form – and with an increasing complexity... We should note, however, the reference to light phenomena (in the form of Plasma Balls) – which seem to be quite common in Crop Circle reports, as we shall see.

In the CCTFS booklet, some interesting points are made in the conclusions:

(4) What could account for a "mist" often seen shortly after the formation of a Crop Circle.

Answer: The water molecules are being oscillated by the energy, which is causing them to vaporise and form a mist.

It also asks about dehydration:

(6) What is causing the disappearance of large volumes of water from Crop Circle areas (Empty water troughs & paddy fields etc.).

Answer: The intense energy beam causes a resonance effect on the water molecules, which is part of the total “cascade” effect of the phenomenon. This includes particle action, molecular vibration, ultrasound and chemical action.

The authors mention the use of microwaves in creating the formations and the resulting residual energy fields they measured. This, I think is very significant and a factor which has been mentioned by Colin Andrews, BLT research and others. We will explore this more in the next section.

Paul Vigay

Paul Vigay visited many formations and had also made some “electric field” and “residual energy” measurements similar to those mentioned in the last section.⁸³⁸ I had the pleasure of meeting Paul Vigay only once, in 2006 at the late David Kingston’s Dorchester conference (which covered the subjects of UFOs and Aliens). I had been asked to do my talk on Antigravity technologies there.

Paul was a very knowledgeable chap, with expertise in software, internet security, encryption and electronics. I have quoted his website - www.cropcircleresearch.com elsewhere in these chapters. One of his theories was that Crop Formations were representations of higher dimensional objects seen from different viewpoints.

Vigay worked with many other Crop Circle researchers, such as [Colin Andrews](#)⁸³⁹ and [Lucy Pringle](#)⁸⁴⁰ and he was very highly regarded.

Also, of note is that Vigay was perhaps the first person to “decode” the “Alien Head” message which we will cover in some detail in chapter 30.

I never realised, until years afterwards, that Paul also [ran several other websites](#)⁸⁴¹ – [including one about 9/11](#)⁸⁴². (I must point out, because of my special interest in 9/11 and my authoring of two books about it, that Paul repeated a fair proportion of the 9/11 disinformation that many other researchers still repeat today.)

Sadly, Paul Vigay was found drowned in the sea near Portsmouth in Feb 2009. Suicide was implied, but the inquest returned an open verdict about his death.

News reports about the circumstances before his death seem to contradict each other. For example, [the Portsmouth News](#)⁸⁴³ wrote:

Claire Diestler, 39, from Bedhampton, said she visited him for a cup of coffee last Tuesday. She said: ‘He was absolutely fine, that’s why I am so shocked.

However, [a report in the Daily Telegraph](#) stated⁸⁴⁴:

Miss Smith, who shared a final meal with her former boyfriend before his death, told the hearing: "It was not aggressive. It was just emotional.

"He was crying, I was crying. I said, 'this is it'.

"I think it has come to the end of the line now."

The story goes on to state that Paul Vigay was heavily in debt, but also quotes Vigay's father:

His father, John, told the inquest: "He had very firm beliefs and he would stick to them. He did not believe in suicide."

Further thoughts about Vigay's death can be found in a [blog post by Syd Walker, which was written shortly after this tragic occurrence.](#)⁸⁴⁵

I have to suggest that Vigay was working in some sensitive areas – if he was talking about protecting privacy, 9/11, Crop Circle energies and other related topics. Perhaps his death was related to his other advocacy work and had little or nothing to do with his Crop Circle research. It is clear from his website, however, Paul was definitely "thinking big" and had studied many of the tricks and deceptions that are constantly played on us.⁸⁴⁶

A peculiar footnote to this affair involves another posting on BLT's website regarding Robbert Van Den Broeke's apparent "channelling" of photographic images of Vigay and David Kingston⁸⁴⁷. I am not entirely sure what to make of the posting, except to say I found it odd that a very similar image to the one shown of David Kingston could be found online, although I couldn't find a similar one of Paul Vigay. I am not sure, either, what Nancy Talbot was really trying to tell us in this posting – which is on a website which is meant to be about Crop Circle research. [You can read more about this "episode" in a comprehensive article by Joel van der Reijden.](#)⁸⁴⁸

27. Plankers and Stompers

(or should this chapter's title be “Plonkers and Stampers...”)

Doug Bower and Dave Chorley



The main explanation put forward by reductionist sceptics is simply that Crop Formations are *all* made using planks of wood, rope, string, maps and markers. As with much of the evidence discussed in this book, because some of it *can be faked*, to the closed-minded reductionist, *all of it must be fake*. The Crop Circle phenomenon was, of course, “explained” in 1991 when the press carried, with the usual dishonest fanfare, the “confession” that two men – Doug Bower and Dave Chorley had been “planking” circles for years.⁸⁴⁹

On 10 Sep 1991, a few weeks before the Channel 4 “Equinox” documentary in which Terence Meaden was “set up,” the “Today” newspaper ran the feature shown

here, across several pages. This time, it appears the victims were Pat Delgado and Colin Andrews. Knowing the timeline a bit better, this probably came as a result of what happened about a year earlier, when Andrews and Delgado were involved in Operation Blackbird, which we will discuss later.

As an example of how ridiculous the claims of Chorley, Bower and the “Today” newspaper were, we can note that already by 1991, formations had appeared across the world – which would have kept them very busy! This point is made in an [extremely detailed and well-researched November 2016 article](#), covering much of the same ground that I cover in these chapters (and more!), by Joel van der Reijden called “Behind The Crop Circle Mystery: Researchers, Sceptics And Hoaxers Secretly Cooperating? The Ultimate In CIA, MI5 and AIVD Psyops”⁸⁴⁸ Also, even after the confession of this dishonest pair, the formations continued to appear – with an apparent peak in 1992, by my calculations.

Circle Makers – “Team Satan”

Some people are not aware that there is an organised, disclosed group of people who purposely go out and make Crop Circles, often for Corporate Sponsors. [The group call themselves “Circle Makers.”](#)⁸⁵⁰

Three of them are John Lundberg, Rod Dickinson and Wil Russell. They use [the following equipment:](#)⁸⁵¹



1. Stalk-stomper, two-piece 6 ft model.
 2. Stalk-stomper, one-piece 4ft model.
 3. Ball of pre-stretched nylon string.
 4. 2 ft long marking pole.
 5. 100ft plastic surveying tape.
- Not shown here:
6. OS Pathfinder map (field boundaries

and pathways). Optional equipment includes: Infrared image intensifier, Dowsing rods/pendulum.

They make no secret that they have been employed [in several TV documentaries to create circles – sometimes to “fool the believers.”](#)⁸⁵²

The Circle Makers have also been given money to create complex formations for advertising campaigns – a couple of examples are shown below – and there are [quite a few more on their website.](#)⁸⁵³

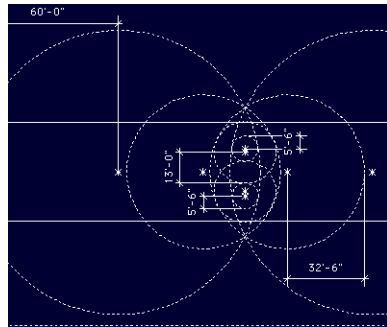

They were commissioned by O2 for this “display,” above, on Blackpool beach⁸⁵⁴, for the August 2003 bank holiday. The design shown is just for the figure 8. On the left we see [their creation for a Nike advert – one of several they did in a “tour of Italy” funded by Nike.](#)⁸⁵⁵

MI5 and the Circle makers?

In [Richard D Hall’s 2009 documentary, “Crop Circles – Hidden Truth,”](#)⁸⁵⁶ he presents evidence of possible links between members of the group and the British Intelligence (or lack thereof) Service MI5. Hall notes:

[John] Lundberg studied Fine Art at Middlesex University, then in 1992 took a Masters in Sculpture at the Slade School of Fine Art in central London... literally next door to his art school was the anonymous headquarters of MI5 [at 140 Gower Street, London]. It housed the Director General and some of the most top-secret and controversial of MI5’s active service units. ... It’s well known that intelligence agencies often recruit agents in their final year of university.

Hall also notes that Lundberg actually started making Crop Circles in the early 90s which presumably means - after he finished art school in 1992 -⁸⁵⁷ shortly after leaving Slate Art college, which was next door to MI5. Hall discusses some interesting features on the Circle Makers Website, which includes hidden references to the CIA and MI5.

```

1 <!DOCTYPE HTML PUBLIC "-//W3C//DTD HTML 3.2 Final//EN">
2 <HTML>
3 <HEAD>
4
5 <META NAME="Keywords" CONTENT="crop circle makers, mi5, security
service, serious crime, british security service, spy, security,
intelligence, terrorism, espionage, proliferation, corn circles,
circlemakers, circle makers, crop circles, pictograms, cerealogy,
fractals, weird shit, aliens, ufo, hoaxers, hoax, hoaxing, fake,
fakers, faking, paranormal, weird, fortean, cerealogy, John
Lundberg, Rod Dickinson, Wil Russell, Robert Irving, Jim Schnabel,
Julian Richardson, Doug and Dave, Doug Bower, Dave Chorley, CIA,
MI5, MBF services, MIB, men in black, apocalypse, 2000, aliens,
UFOs, black watch, landscape art">
6 <META NAME="Description" CONTENT="circlemakers: Home of England's
crop circle makers. Making the world a more interesting place.">
7
8 <SCRIPT LANGUAGE="JavaScript">
9 <!--
10
11 if (document.images) {
12     var nav1off = new Image();

```

HTML source code from “New Documents” page on Circle Makers website⁸⁵⁸ on 16 Feb 2019

Hall also noted a 2004 “News Update” on their site (see bottom of “New Documents page”⁸⁵⁹)

NEWS UPDATE 06-03-2004:
Well, it looks like veteran crop circle researcher Colin Andrews (pictured right) might be forced to go get a real job! He's posted an urgent [appeal for funds](#) on his website stating that "unless funds are secured within the next four weeks, the complete operation will close". If you want to help Colin out, you can make a tax deductible [donation](#) via his website.



We'll be meeting up with Colin at the edge of a field in Wiltshire in the next few days to hand over a brown envelope "stuffed with cash". We hope he can sort out his finances, because if he does bow out of the crop circle research field he would leave a huge void in his wake. Colin, can we suggest that you give Freddy Silva a call, as - if he is to be believed - sales of his crop circle screed "Secrets in the Fields" have now topped twenty thousand, I'm sure he'd love to plough some of the profits from the book back into crop circle research, eh Freddy?

If all else fails maybe Colin could join [MI5's](#) psy-ops department and retrain as a crop circle maker...

From the Circle Makers website. Why are “MI5 Psy-ops” mentioned here?

Hall also looked into Lundberg’s financial background and [found that he set up three companies in September 1999 with non-descript names](#),⁸⁶⁰ filed with non-descript business types. One of these companies was dissolved before

trading and the others had minimal assets and were dissolved within three years of their creation/filing.

Hall completed land registry checks on Lundberg's London residence and found that Lundberg's apartment (and 3 neighbouring properties), built in 1995, had probably not been sold since the apartment building was constructed. It was registered as being on a neighbouring plot of land, rather than where it actually was. Hall's enquiries showed that Lundberg's rent was being paid by someone else.

Hall notes what Lundberg has said in interviews about keeping his art anonymous⁸⁶¹ – the opposite of the way in which most other works of art are presented.

Hall also notes possible clues to how Lundberg could keep his operation going...

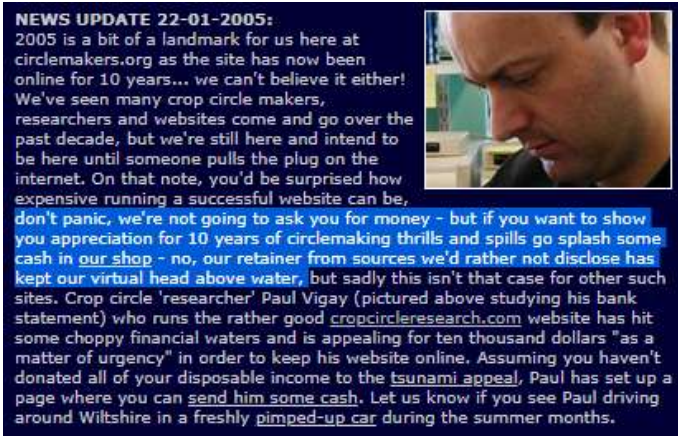

NEWS UPDATE 22-01-2005:
2005 is a bit of a landmark for us here at circlemakers.org as the site has now been online for 10 years... we can't believe it either! We've seen many crop circle makers, researchers and websites come and go over the past decade, but we're still here and intend to be here until someone pulls the plug on the internet. On that note, you'd be surprised how expensive running a successful website can be, don't panic, we're not going to ask you for money - but if you want to show you appreciation for 10 years of circlemaking thrills and spills go splash some cash in our shop - no, our retainer from sources we'd rather not disclose has kept our virtual head above water, but sadly this isn't that case for other such sites. Crop circle 'researcher' Paul Vigay (pictured above studying his bank statement) who runs the rather good croppcircleresearch.com website has hit some choppy financial waters and is appealing for ten thousand dollars "as a matter of urgency" in order to keep his website online. Assuming you haven't donated all of your disposable income to the [tsunami appeal](#), Paul has set up a page where you can [send him some cash](#). Let us know if you see Paul driving around Wiltshire in a freshly [pimped-up car](#) during the summer months.



Who was funding CircleMakers?

Circle Makers – Coincidence and Weird Happenings.

Even the “confessed hoaxers” have reported strange events connected with their activities. For example, in a posting titled “Round in Squares,”⁸⁶² the Circle Makers site explains one formation they created in August 2004, but also notes a related “coincidence.”



Woodingdean

“At the beginning of August 2004 circlemakers John Lundberg, Rod Dickinson and Wil Russell were asked by National Geographic TV to create a demonstration formation in daylight opposite Silbury Hill in

Wiltshire for a documentary on the Crop Circle phenomenon. We decided to create a 200ft formation incorporating a square spiral. Until now square spirals have not appeared out in the fields, probably because unlike a circular spiral - a square spiral is a complex geometric form and difficult to create accurately. It took 3 of us a very sedate 5 hours to create, with lots of breaks in construction for filming.”

“As far as we were aware at the time, no previous Crop Circle design had incorporated a square spiral, or water snake as it is sometimes called. But in one of **those cosmic coincidences that happen frequently in a subject like this, we’ve now seen reports of a square spiral formation at Woodingdean in East Sussex (pictured right)** which appeared a few days before we created ours on camera, although unlike our formation its construction seems somewhat haphazard.”

Another posting by Julian Richardson reports⁸⁶³ a 1992 sighting of an orange or amber ball of light:

Towards the end of the 1992 season, our circle making team decided to test our refined techniques by attempting to produce what was, at the time, probably the most complicated design ever. It was whilst creating that formation that the following event occurred: As the sky grew darker, we slowly walked along the narrow footpath that ran alongside our intended canvas for the night. I knew we had to start early if we had any chance of completing the formation before daybreak.

“... After about an hour, we three circle makers converged on the same point and began quietly discussing our progress. **Suddenly my attention was drawn to a light that had appeared from nowhere. It was a few hundred yards away and directly in front of us.** As soon as I’d registered its presence, I alerted my colleagues. Amazed, we stood there gazing at this football-sized orange light as it hung motionless, about forty feet above the surrounding countryside. After an estimated five seconds the light began to slowly descend. Within another five seconds, it had descended about ten feet and had faded into invisibility. With little time to spare, we excitedly returned to our work, always hopeful of a repeat performance.”

“Subsequent daylight checks revealed no evidence of the light’s existence. That year also saw a large increase in the number of luminosities reported around circle sites. **Did we witness a naturally occurring phenomenon - or were we really being scanned by the genuine circlemakers?**”

Similarly, another posting by John Lundberg discusses his sighting of bursts of light during their activities in 1994.⁸⁶⁴

Hoaxers and Skeptics Unite!

Hardly surprising that the circle makers site celebrated the 90th birthday of the hoaxer Doug Bower:⁸⁵⁹

NEWS UPDATE 25-06-2014:

Circle makers Commander-in-chief Doug Bower - who swirled his first circle in 1976 - is 90 years young today.

All of us here at Circle makers HQ wish him a happy and mischievous birthday! Circlemaker John Lundberg spoke to Doug earlier today, and was told “I’m making myself a new stomper!” See you in the fields Doug!

Of similar note is their co-operation with sceptic/debunker Mark Pilkington and others such as the deceitful journalist John Ronson, in the making of the film “Mirage Men.”⁸⁶⁵

Stomped Signatures

Colin Andrews and others have noted that it is often possible to tell, from the lay of the crop stems, if it has been mechanically created.

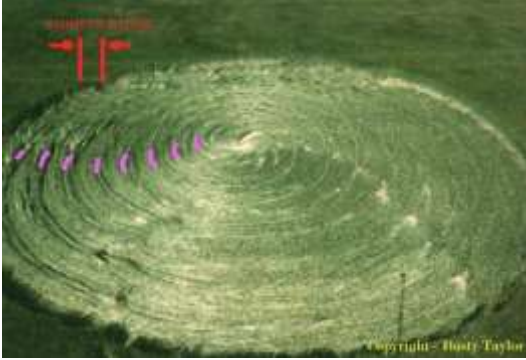

This photo shows a formation made by Doug Bower and Dave Chorley in May 1989 near Cheesefoot Head, Winchester, England. Note the numerous rotations of the spiral fingerprint – consistent with being made with a 1.2 meter-wide ‘stomper’ board.

Researchers David Cayton and Robert Hulse have repeatedly noted how stems show “board marks” where they have been slightly damaged by the edge of a board.⁸⁶⁶ They also note how these aren’t always easy to see – especially later in the growth of the crop – and therefore easily missed, leading to the wrong conclusion about how the formation was made.

Characteristic Crop Circle “Swirls”

Colin Andrews and others have argued that non-mechanically produced (NMP) formations showed particular patterns of “swirling” of stems in the flattened crop. This is illustrated in one of Andrews’ archived articles thus⁸⁶⁷:



14th August 1986, one of the first circles discovered with a single concentric ring but again note the ‘swirl signature’ which is around 0.25 of a rotation. No stomper board marks or multiple rotations present. Copyright: Colin Andrews 1986.

We will return to this “swirling” characteristic later.

In the next chapter, I will discuss several other phenomena witnessed in relation to the creation of Crop Formations which can help to distinguish between those mechanically and those non-mechanically created.

28. Phenomena Associated with Crop Formation Appearance

In this chapter, we will look phenomena associated with Crop Circles/formations which should give us some clues as to the method of their creation.

Before going in to more detail, we can mention one feature that has been seen in some formations, such as [the one in Ogbourne St. George, Wiltshire, 15th Jun 2003](#).⁸⁶⁸ In Richard D Hall's "Crop Circles – Hidden Truth Documentary," Hall, David Cayton and Robert Hulse note how the crop stems in this formation had *not* been flattened to the ground.⁸⁶⁹ Rather, the formation only had *partly flattened* crop stems – meaning the formation looked quite “faint” when viewed from the ground, but looked much clearer when viewed from the air. Once again, this rules out the sceptic’s explanatory refuge of mechanical creation.

Changes in the Plants/Soil in Crop Formations

We will re-visit this particular area in a later chapter, but for now we will note some research from [the afore-mentioned CCTFS booklet](#)⁸³⁶, along with some quotes/data from the archives of BLT research.

Burn Marks and Exploded Nodes

These have been observed on many samples. The CCTFS booklet includes the following images:



Barley Mansfield, Notts, 6th July 1991



Wheat - Sutton on Trent, Notts, 6th July 1991



Wheat - Husbands Bosworth, Notts, 7th July 1990

The darkened areas on these stems should not be there – they tend to indicate that some type of anomalous heating has taken place.

More Burn Marks, Exploded Nodes and Plant Abnormalities

An interesting and detailed posting on BLT's website shows similar burn marks along with other abnormalities.⁸⁷⁰ The article reports:

The physical changes (listed below) documented in Crop Circle plants by Michigan biophysicist W.C. Levensgood have been determined by evaluating hundreds of sample plants—both downed and standing—taken from inside the overall perimeter of each formation against hundreds of control plants taken at varying distances outside each formation, in several directions. More than 250 individual Crop Formations from multiple countries, over a 10-year period were examined in-depth. Although many of the formations studied were relatively “simple” in overall design and/or relatively “small” in overall size (primarily because of BLT’s financial and/or personnel limitations, particularly in Europe), many larger and more “complex” formations—those whose overall design included intricate geometric shapes with multiple design elements of varying sizes—are represented here.

The following types of changes are reported:

- On the microscopic level, abnormal enlargement of cell wall pits in bract tissue (a thin membrane which surrounds the seed-head and through which nutrients pass to the developing seed)
- Enlarged (both laterally and longitudinally) plant stem nodes
- Bending around stem nodes

- Bending at the base of the plant stem
- Expulsion cavities
- Stunted, malformed seeds and germination effects

A number of photographs of the samples, all taken by W.C. Levengood, are included:



Expulsion cavity in corn (maize). Thought to result from intense, very brief bursts of microwaves which instantly turn the moisture inside the plant stem nodes to steam.



Sample plants with apical node elongation and extreme bending, in wheat from a Maryland, USA Crop Formation.

The photo on the right – and others in the article referenced above – appear to show similar “burn marks” to the stems from the UK Crop Formations, shown above.



Twisting and spiralling of the somatic tissues at the base of the seed-head. [Noted in another BLT article.](#)⁷⁹⁶

Enhanced or altered Growth

This has been noted in fields where crops have been grown in the year following the appearance of a formation. [This enhanced growth effect is also shown on BLT's website:](#)⁷⁹⁶



Top plant: August, 2000: Control plants from outside '99 formation area. Bottom plant: August, 2000: Sample plants from downed area inside 1999 "Dolphin," which are a darker green & taller than controls.

Levengood writes:⁸⁷⁰

5(d) Finally, when Crop Circles occur in mature plants with fully formed seeds, these seeds often exhibit a statistically significant massive increase in growth rate and vigor, with growth-rate up to five times the rate of the control seeds. Further, these seedlings can tolerate extreme stress (lack of water and/or light) for considerable periods of time without apparent harm.



Increased growth-rate of formation seedlings - (as opposed to controls), in seeds from crop which was mature when Crop Circle formed.



Stunted & dehydrated Maize seeds (on right). These occur when embryos are already formed, or partially formed, when Crop Circle occurs.

Levengood therefore notes that the growth and germination effects in later plants depend on when the parent plants were affected by the Crop Formation:

5 (b) When Crop Circles occur at a slightly later growth stage, in young crop where the seed is still forming, the developing embryo fails to grow normally. These seeds will be visually stunted (smaller), will weigh less than their controls, and will exhibit reduced or repressed germination. Here, the reproductive capacity of the plant has been compromised.

Crop Stem Creases

These have been observed in crops that have *not* been flattened by planks. As noted in the CCTFS booklet, regarding samples collected from 2 different sites in Nottinghamshire, UK:



Carlton on Trent, 9th July 1991

The disclosure that “bent stems” in Crop Circles may hold valuable clues to the source of the energy involved, has been publicised for the benefit of all researchers. After studying “Crop Circles” since 1985 and collecting and analysing plant stems from incidents up to 150 miles apart, one common denominator emerged. This was the discovery of single standing stems, with top sections bent over at a height of 55cm (22”) in an otherwise flattened circle of Wheat or Barley. (See graph below)

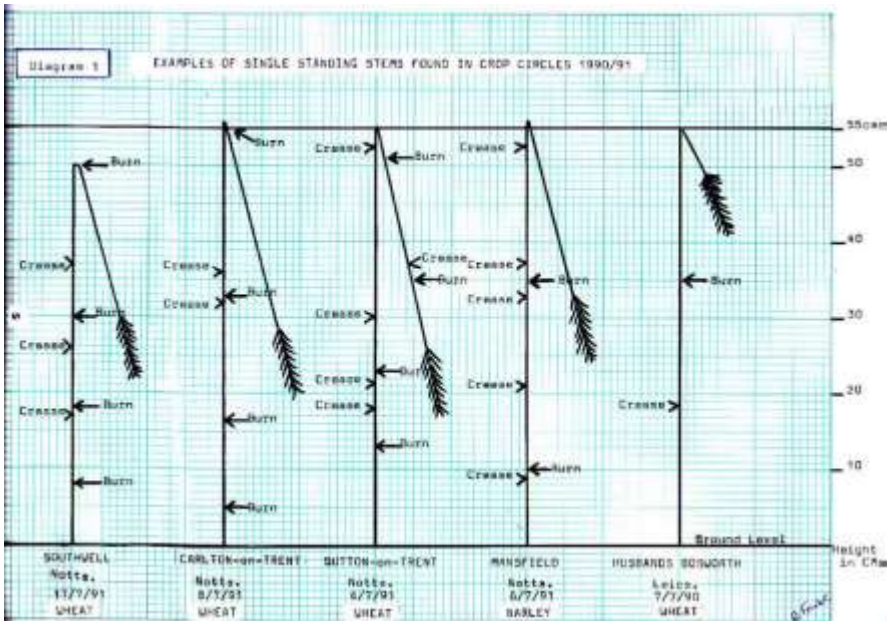

The CCTFS booklet continues:

It is believed that the 55cm stem measurement is indicative of H/F wavelength (Microwave) activity. The “crease” marks and small burnt areas which appear at regular intervals on the stems, could be consistent with Microwave action during the formation of a Crop Circle.

To explain this a little more, the wavelengths of microwaves are in the “centimetre” range which means that they tend to affect things that have this sort of physical length. The suggestion here is that the crop stems act like a “receiver” or “aerial” for the microwaves as they are “straight rods.” A wavelength of 55cm corresponds to a frequency of about 545 MHz⁸⁷¹ – suggesting that a frequency in this region might be used – either as a “main” frequency or a harmonic.

Magnetized Crop Stems

Thanks to information given to me by David Cayton, I learned that in 1995, Busty Taylor appeared on the ITV “Good Morning” programme to show Crop Formation stem and soil samples he’d collected in 1993.⁸⁷² This included magnetized lumps of “chalk and stone” and a magnetized crop stem or branch:



The crop stem is near the bottom left of the image.



Busty Taylor demonstrates the magnetic attraction on “Good Morning”

Of course, sceptics would just dismiss this and say a pin or needle had simply been inserted into the stem. I disagree...

Soil Effects

Magnetized Iron Spheres

This discovery, which is one I ended up attaching particular importance to, was made by W.C. Levengood, in soils from a 1993 Crop Formation at Cherhill, England. Here, some of the epicentre plants were coated with an iron “glaze,” shown in the image below, with Levengood’s caption⁸⁷³.



Photomicrograph (100 X) of 10-40-micron diameter, spherical, magnetic particles of the type regularly found in Crop Circle soils. EDS reveals these spheres to be pure iron; the fact that

they are magnetized reveals they were formed in a magnetic field.

The article states that the formation occurred during the Perseid Meteor Shower (an annual event, which takes place around 13th August):

Most often these highly magnetized spherical particles are found clustered around (or just outside) the perimeters of circularly-shaped Crop Formations, suggesting that centrifugal force is distributing this material out toward the edges of the flattened areas. However, we have also examined a few cases in which the major deposition of the magnetic material has been in the centers of the flattened circular components.

They suggest, however, that the iron came from meteoric dust:

... microscopic particles of meteoric dust (which are filtering toward earth constantly as meteors burn upon entering the earth's atmosphere, and which would be more abundant during an actual meteor shower) were drawn into the descending plasma system by the strong magnetic fields known to be associated with plasmas, then heated to a molten state by the microwaves (also known to be associated with plasma systems) prior to impact with the earth's surface.

This explanation seems doubtful to me – the chances of this actually occurring are minimal – particularly in view of how rarefied the meteoric dust is in the case of the Perseid shower. In any case, the article notes that such spheres were found in soils taken from other circles, such as one in Midale, Saskatchewan, Canada in September, 1999.

The authors again try to connect in the “Plasma vortex” theory to explain the effects observed. I think the correct explanation for what is happening here is rather different, as we will see later.

Heating and Crystallisation

BLT's website also includes a study on the soil in a Crop Formation which was found in Sept 1999 in Edmonton, Alberta, Canada.⁸⁷⁴ BLT notes that circumstances suggest this formation was probably not planked:

The fact that the field was infested with Canadian thistle, which made it almost impossible to walk in the field without high protective boots, tended to further rule out the possibility that this formation had been mechanically produced.

The design of the formation is shown in the diagram below:

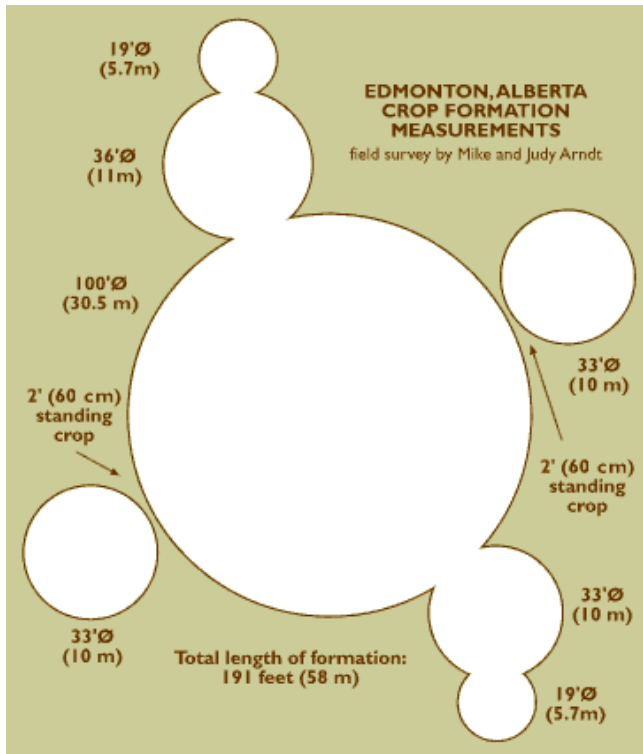

The article notes:

Clay minerals (illite/smectites) extracted from surface soils taken at the same sampling locations as the affected plants, were submitted to X-ray diffraction [XRD] analysis.

The results were submitted to Dr Robert C. Reynolds, Jr. of Dept. of Earth Sciences at Dartmouth College in New Hampshire. Reynolds was a well-respected scientist in the field of [XRD](#), which is a method to determine the structure of crystals.⁸⁷⁵ The BLT article includes a letter from Reynolds, and describes how the sampled soil contained mica crystals which had shown abnormal growth:

*In Reynold's words, "the possibility of crystal growth seems remote." The degree of pressure known to be involved in causing crystal growth in sedimentary deposits would have, had it been present, completely obliterated the plants. And the 600-800°C temperatures, over a period of several hours, known to be necessary to promote such crystal growth in the laboratory would have, in the Crop Circle field, incinerated any plant material present. **Additionally, the very brief bursts of possibly intense microwave radiation, thought to be the cause of node-elongation and the creation of expulsion cavities (through heating and expansion of internal stem moisture) could not account for crystal growth.***

(Reynolds, who has since passed on, said he could not explain the results. In July 2010, someone wrote to me about Robert C Reynolds and how they respected him – as he was their professor.)

In summary, this study suggests to me that within the Crop Formation, we see the effects of some kind of heating, but then it was extremely localised – not destroying the plants. What can do that?

UK Government Tested Samples in the 1980s

In his “Crop Circles - Hidden Truth” film, Richard D Hall notes that the British Government did do some investigation into Crop Circle plant and soil samples.⁸⁷⁶ These samples were sent to ADAS (Agricultural Consultants)⁸⁷⁷ and tested at a lab in Wolverhampton. According to what David Cayton said in the film, the lab reported similar findings to those of BLT’s W.C. Levengood and then the scientists doing the tests were sacked/fired from their jobs, some months later, following questions being asked in the UK Parliament about the “wasting of public money on investigating silly Crop Circles.”⁸⁷⁸

Light Phenomena

In an article I have already referenced several times, BLT research correctly notes⁷⁹⁶:

Light Phenomena: Ever since people began paying attention to Crop Circles strange balls of light (BOLs), frequently softball-size but sometimes smaller or larger, have been regularly seen, photographed and/or videotaped in and around the fields the circles historically are known to frequent. These BOLs are seen in daytime as well as at night, and have now been observed (and in many cases videotaped) in every country where Crop Circles are studied.

We will now mention a couple of incidents where these have been seen.

On a Coast to Coast Broadcast on 02 Nov 2005,⁸⁷⁹ Crop Formation researcher Ed Sherwood described some of his sightings of BOLs, one of which he appeared to interact with. Sherwood also noted that helicopters have intercepted these ball plasmas (and this is shown in a video clip from Colin Andrews, discussed later)

I've seen one from a distance create a Crop Circle formation... There's many things that would differentiate these plasmas... Also [they] do appear worldwide and they're known in a lot of different areas like in the Hessedalen Valley of Norway...

I asked on camera, with two of the witnesses, if it could show us that it was aware of our presence - by either moving dramatically, changing form... and/or increasing in brightness - and within seconds, it did all three. And it was four miles from us. So it showed that there was actually no distance whatsoever between the consciousness of the observer making that request and the ball plasma - four miles away - responding to the request.

A month after, a woman photographed [a ball plasma] ... she asked me how to photograph a ball plasma and I said “Well ask first...” She went up the hill... disappeared over the hill - and her car stalled... and this ball of light rose up behind the hedge and... She asked first she had the presence of mind to ask... it just sat there - and let her roll off a whole load of film.

Sherwood was then asked if he thought the plasma made the Crop Formation.

No... I feel that the ball plasmas are part of the creative process. They may be there, they may not be there. They may be there - but not visible. They may be in the vicinity. I've witnessed more than 100 ball plasmas in the last 15 years and I only saw one create a Crop Circle from a distance.

Colin Andrews and Others Film BOL in 1994

Andrews reported when a BOL was filmed, in the days following 21st July 1994, when a [new formation \(which looked like the CBS logo\) had appeared in a field in East Field, Wiltshire](#)⁸⁸⁰. Colin Andrews related the story in a video posted in 2009. This video also includes footage of the incident that Andrews and his colleagues filmed (the quality is not quite good enough to see the BOL, though the witnesses mention it.) [The military helicopter gets quite close.](#)⁸⁸¹ [Freddy Silva has a description of the incident on his website.](#)⁸⁸² Andrews?

If the media had been turned off by the premeditated hoax stories, the army certainly hadn't. In one blatant incident a CPRI [Colin Andrews'] research team was harassed on a road overlooking the East Field by two unmarked army helicopters. The craft was actually stooping so near the research team that it nearly collided with the nearby tumulus. As Colin describes: "one of us grabbed the video camera and filmed how one of the helicopters was roaring about us in a kind of low-level attack. The second helicopter, full of recording equipment, hovered a few feet in front of us. Minutes later they turned around, heading towards the pictograms already in the field, where one researcher was taking photos. He had to duck. Then the second helicopter shot toward a neighbouring field, seeming to have traced something, which we now saw and took film of: a luminous ball, about one foot in diameter, gliding through the cornfield. The helicopters went into tilting position, seeming to be filming the object before the object shot away. Then the helicopters turned around, leaving the area." The video of this incident was later confiscated by the authorities, but not before copies had been made.

BOL at Barbury Castle "Dolphins" Crop Circle in August, 1999



This formation was made on 23rd or 24th July 1999⁸⁸³ and was visited by a few people. [Martin Keitel has a report on the video, which he digitised himself, on his website.](#)⁸⁸⁴ The camera man, was Don Fletcher.

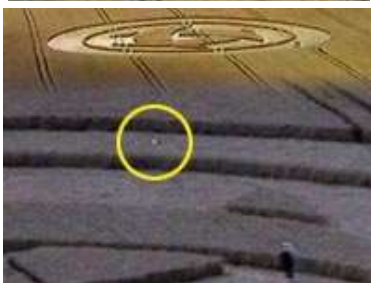

"The luminosities visible in this video were certainly present at the location, on that early August afternoon (sorry, I have lost the exact date). A totally different matter is what they really are...."

An interesting detail in the film is that none of the people present in the Crop Circle seem to notice anything. The possible explanation is that the luminosities are actually flying much higher above the field than it seems. It's very hard to determine the height, when there is no apparent shadow cast by the objects.

Another possibility is that the objects are partly transparent, so that they could be clearly seen only from an angle with a strong reflection.

Don [Fletcher] has a very balanced and tranquil attitude towards these phenomena, which I think is essential in order to encounter them. Additionally he is a very kind-hearted person and knowing him, I don't see any way how he could be involved in some kind of a conspiracy to fool people."

Nancy Talbot's 2001 Eyewitness Account in the Netherlands

Nancy Talbot of BLT Research and Robbert van der Broeke witnessed a beam of light in Hoeven, Holland, in the early morning of August 21, 2001⁸⁸⁵:

"About 3:15 am an intense white column, or tube, of light—about 8 inches to 1 foot in diameter flashed down from the sky to the ground, illuminating my bedroom and the sky as brilliantly as if from helicopter searchlights. The entire light display took 5-6 seconds; if the bawling cattle are considered to be part of this situation the total time would be about 10 minutes.

In a few seconds, a third tube of light flashed down to the ground. Robbert saw only two tubes of light,

Later that night Robbert reported that he had heard the dog next door barking furiously just prior to the appearance of the light-tubes."

Nancy reported:

At dawn the next day, from my bed, I could clearly see the new circle—which turned out to be, in fact, an ellipse of about 35 ft. in length (running East/West) and 20 ft. in width (North/South diameter), with a 20 ft.-long pathway adjoining the northern edge which ended in a crossbar (like the capital letter "T").

Further information can be found on the BLT website.

The Hessdalen Connection?

The Hessdalen Light Phenomenon, observed since the 1940s⁸⁸⁶, has been investigated by Erling Strand⁸⁸⁷ since the early 80s. It is similar to other light phenomena such as the Marfa Lights in the US and possibly similar to what Mike Freebury found when he was studying incidences of animal mutilation in Powys, Wales.⁸⁸⁸ I am not familiar with any Crop Circle reports from the Hessdalen Valley – or even if they grow any crops there! However, it is referenced here because of a particular associated phenomenon that has also been found there – Iron Microspheres⁸⁸⁹, which we mentioned in the "Soil Effects" section:

6. GROUND-SAMPLE ANALYSIS

Three ground-samples were collected close to a river near Vårhus , where a very close sighting of a light-orb was reported by Norwegian people. They consisted of:

A. Target Sample. Some grams of powder deposited on a rock which was showing to be slightly radioactive (0,020 mR/h).

B. Control Sample 1. Some grams of powder from a rock with no radioactivity which was about 10 meters far from the first rock.

C. Control Sample 2. About 1 Kg of earth which was extracted by means of the “carrotting technique” at about 10 meters from the target sample and at a depth of about 10 cm. The laboratory analysis, which was carried out at the SACMI Imola industry [see Acknowledgements], is described as follows.

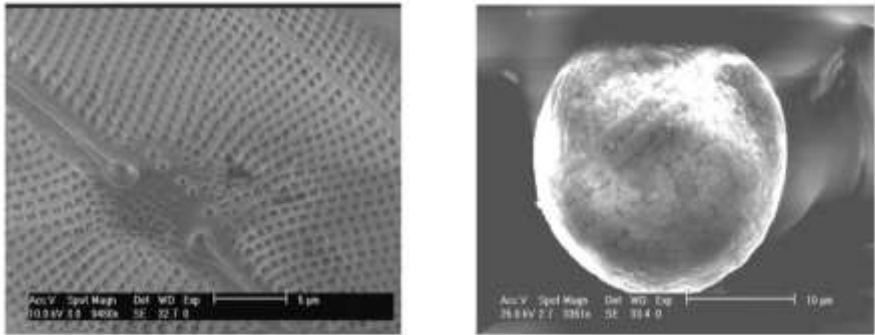

Figure 8. Electronic microscopic analysis. *Left:* Silicon tissue. *Right:* Spheroidal iron particle (luminous areas are due to signal saturation).

SEM images of Iron Microsphere – from soils collected when Hessdalen Lights are Seen

Magnetic Field Changes and Sounds

These have been reported by Colin Andrews and others. [Andrews reported in an interview on Paranet on 3rd Dec 1995](#)⁸⁹⁰,

Whilst the television camera was rolling, we recorded a sound... Also, that same sound has been heard before. I've heard it three times myself - it's 5.2 kilohertz in audible frequency.

A careful study of these sounds⁸⁹¹, suggests that at least in some cases (maybe all), it is simply a grasshopper warbler or similar bird. (Though a range of sounds have been recorded). In the instance Andrews describes in this interview, for example, he also says:

We're beginning to see the evidence now with the magnetometer surveys that are better being conducted that indeed the magnetic field of usually about 5 Gauss, in the Northern Hemisphere... is exceeded by 300% inside the Crop Circles themselves. Of course, this too cannot be replicated by people hoaxing them ...

Levitation

Freddy Silva Levitated

Before I include a portion of his account, I will include a little information about him.



Freddy Silva generally just discusses the more “mystical” and metaphysical aspects of the phenomenon, believing that it is largely the work of “higher” spiritual forces. The [biography on his website reveals little about his “non-Crop Circle” or professional experience](#)⁸⁹². From a different perspective, I am interested in what Silva has to say, which like Nancy Talbot’s earlier statements, relates to consciousness.

I agree with Freddy, and others who offer similar sentiments, that studying the Crop Circle/Formation phenomenon impacts on your consciousness and tends to “open things up.” For some people, this comes as a direct experience of either witnessing a formation being made, or sitting or standing inside of one and trying to work out how it was made, or what its function is.

To me, however, the key factor is arousing one’s curiosity and making one realise that forces that we can’t easily comprehend are at work. Some people don’t want to try and comprehend those forces and some *do want to comprehend them*. They then open themselves to the larger reality and usually, this change is not reversible.

Freddy has some very useful pages on his website, documenting the history of the phenomenon and I have already referenced these in this book several times.

Here I wanted to mention a brief account he gave in a Coast to Coast Interview on 23 May 2005.

I have no doubt in my mind from my personal experiences that there’s nothing but benevolence that comes from this phenomenon. I’ve seen balls of light... I’ve been levitated off the ground, in a Crop Circle - much to my amazement - which still baffles me to this day.

The host, George Noory asked Silva how high he ascended, but Silva said he had “no idea”:

It was 1997 when I went into a circle - and about a time when that everything about sound was concreting in my mind everything was pointing to sound for me again ... I played this tape of this music and I lay down in the Crop Circle in 1997 in England. A beautiful, beautiful pattern and I just remember being knocked out... a huge blow - just being hit on the back of my shoulders... Actually it didn’t hurt - it’s almost like as a joke like Dr Spock came up behind you and ... they pinched one of your nerves and I just sort of relaxed. I just began to rise out of my body - I could see my hands flying around me. I’m being surrounded by these very, very tall beings and just being loved. All I can remember was this incredible feeling of unconditional love - and this information was just being downloaded into me...

This account suggests that Silva was physically lifted off the ground by some type of “blow” although it is also suggestive of an “Out of Body” experience too. Noory asked Silva “how high” he ascended, but Silva stated he “didn’t know.”

Pat Delgado Levitated

In an article on Colin Andrews' website, we can read an account by the late Pat Delgado regarding an event which happened in 1989.⁸⁹³

The unusual events at White Crow occurred on the night of Saturday/Sunday 17-18th June, 1989, when six people climbed up Cheesefoot Head hill and sat in a Crop Circle at midnight.

*Standing at the southern position with Colin, I was controlled to reach out and sweep energy from the sound into Colin's body. I do not know why. Colin then left me and returned to the group at the top of the circle. I turned towards the sound and my arms were being pulled over the crop **with an even greater force and my body felt it was being pulled upward and forward out of the circle at some perilous angle.** With all the strength I could muster, I managed to withdraw my arms, gradually sink down and turn around so I was now facing north. I eventually laid down on my stomach and began to inch my way up the centre of the sloping circle floor, grabbing at bunches of flattened barley stems and pushing with my knees and feet.*

Again, we can read on Colin Andrews' site:



*I was becoming totally exhausted and at that moment I **wondered what I was fighting against.** There was nothing tangible, but I was **under the control of some force of incredible strength.***

Delgado describes struggling to get help from Colin Andrews, who was nearby, while Delgado was struggling against this force. After further efforts, they managed to break away from it and then Delgado reported:

For some minutes we sat there answering questions as to what had happened when suddenly some force levitated me to a height just brushing the flattened crop and floated me to the east side of the circle. Now I was feeling really scared. What force could have moved me a distance of about three metres while still in the same sitting position?

“What force” indeed...? Keep reading...

29. Microwave Energy, Operation Blackbird, and Crop Formations

We have already mentioned the possibly or even likely importance of Microwave radiation in the creation of Crop Formations – and it is a topic which most of the researchers are aware of and have commented on. We can also note that there is association between plasmoids, plasma balls, light phenomena and microwaves. [Indeed, people seem to have created light phenomena or ball lightening by putting a burning candle in their domestic microwave ovens!](#)⁸⁹⁴

Referring back to Omar Fowler’s CCTFS booklet, we find a list relating to Crop Formation effects that microwaves could explain:

- What force, normally invisible, is capable of such action within such a short duration of time (possibly 20 seconds).
- What can account for the ‘Plasma Balls’ photographed by Japanese and British scientists over the wheat fields in England, where Crop Formations have later been discovered.
- How can Crop Formations occur either during the day or night and without detection by local radar or night vision cameras. With or without any wind, for instance in a mist at night e.g. Wiltshire 27th June 1991.
- What could account for a ‘mist’ often seen shortly after the formation of a Crop Circle.
- What could be responsible for the ‘chirping’ and ‘tweeting’ sounds recorded in Crop Formations and thought to be caused by H/F radiation.
- Crop Stems show exploded nodes and localised heating effects.

We can therefore suggest that “tuned microwaves” are being used. Further, we can consider the use of much more advanced techniques such as [Phase Conjugation](#)⁸⁹⁵. Explaining this technique is beyond the scope of this book, I can only [reference a paper relating to the technique’s use with microwaves](#)⁸⁹⁶.

Colin Andrews on Micro Wave Energy

In an interview on a radio show hosted by Michael Corbin called “Paranet” on 3rd Dec 1995, Andrews talked about the Crop Circle phenomenon and shared his views on the use of microwave energy for the creation of them.

...Most of this activity is occurring [in] the largest out of bounds area - that is out of bounds to the public - a military area in Europe. It's called Salisbury Plain and the public do not have access. It's very secure and... the military have available to them a huge drawing board of reflective vegetation - for such experimentation - which might emanate from "airborne satellite..." techniques... But it's not the place that's chosen for the drawing board. It's in public areas, some of them are very close to major highways. And the phenomenon ... began actually before 1946... but was occurring in the period prior to the airborne technology - that you and I are now suggesting

may or may not be involved. My take on it is that this is not a military situation at all.

Well, whilst I personally would discount the satellite technology, I would not discount microwaves... There certainly seems to be evidence that the internal elements of the plants themselves the moisture has been extracted... removed from the plants during the construction (growing) phase. The scientific evidence now shows us... that the cell walls inside the plants involved - are fractured. That's certainly indicative of an internal increase in temperature... and experiments in the laboratory can pretty well replicate a simple circle by rotating a dish with growing plants on and you'll see a spiral effect - the plants collapse. The difference is very much though that whereas the plants in the Crop Circles continue to grow perfectly well, inside the microwave experiments (where the plants are microwaved) ... they die very very quickly...

Whilst it is peculiar for Andrews to say that “*this is not a military situation at all*” (as we shall see shortly), he makes a good point about the destructive effect of a microwave beam on living plants. This must mean that if microwaves are involved, as many researchers have said, they are not the same as the microwaves generated in a domestic microwave oven – those sorts of microwaves would be too destructive. Hence, they must be either pulsed or modulated or polarised in some way to achieve certain effects and not others.

Operation Blackbird – 1990

In the 1980s, it seems that the then [Prime Minister of the UK, Margaret Thatcher was asking questions](#)⁸⁹⁷ about Crop Circles and it was she that approved an Army-backed investigation into the phenomenon. It came to pass that in the summer of 1990, Colin Andrews supervised the largest surveillance project of its kind, called ‘Operation Blackbird’. It was an effort to film a Crop Circle forming, backed and supported by the British Army, BBC and Nippon television and was watched closely by the international media. [Andrews and Pat Delgado were seen on national and international media over a period of several days](#)⁸⁹⁸. It was also later revealed by Andrews that the Army were filming at another site at [Silbury Hill, 17 miles away from the site of Operation Blackbird](#)⁸⁹⁹.





Photos from Colin Andrews (left) – who, with Pat Delgado (right), is coordinating procedures with the army at Operation Blackbird.

Removal and Substitution of Video Recording of Formation

On 22 Dec 2005 on George Noory's Coast to Coast show (with Hilly Rose guest hosting),⁹⁰⁰ Andrews made new revelations about 1 important event in the Operation Blackbird project, where the (non-mechanical) formation of a Crop Circle was filmed, but the tape was removed and substituted for another tape showing nothing happening.

The tape that was given into the system... for analysis was from the same camera position as the one that captured the event, but it was filmed several nights before... It was known to have the same topography, the same landscape but it had a different event. What was different between the original [was] ... the replacement showed nothing happening... it showed a night when nothing happened. That was not intended and people behind this which was totally infiltrated by the military – [we] had uniformed military personnel with us on the site... The military [or] the government did not intend that material - if we were lucky enough to see this form ... They had enough personnel infiltrated into the organization to remove it... They did not want the public to see what eyewitnesses have seen.

Andrews also described why that site had been chosen as an observation point for Operation Blackbird.

Ray Barnes witnessed a Crop Circle form, in about 10 seconds - like all the other eyewitnesses around the world. Now here we are lucky enough to get something on tape and somebody decides ... It has to be nailed at the feet of the British government... [They decide] we are not going to be seeing this.

Ongoing Military Observations

Many Crop Circle researchers have both reported and filmed the presence of military helicopters right over formations⁹⁰¹ – and this seems to have been happening regularly, even after “Operation Blackbird” ended in 1990. A perusal of YouTube for relevant videos is definitely an interesting exercise.⁹⁰²

Farmer Witnesses Black Beams Disturbing the Ground

In his CCHT documentary, Hall includes a clip where a farmer named Albert Bull is interviewed (by Engineer Roy Dutton, who we will mention again in the next chapter) on site and he describes his sighting of vertical beams in a field of Winter Barley that he owned. The farmer described an event which took place on 24 August 1990:

It was overcast - no sunshine, sort of a dullish day. It's this field here (points). It was in winter barley at the time. It's a corn field most of the time... the first one [I saw], where I was stood in the field and nearby. Then, when that died away, the second one appeared - nearer the tree over in the far distance (points) and suddenly in front of me was a tube running up about a thousand feet or... I would say a thousand feet plus... coming down (from somewhere) out of sight onto the ground. This was not very many yards away from me.

The important point about it that struck me... was the circular motion of the ashes in the grit on the ground. It didn't appear to be being sucked up - the tube... it was just rotating at a high speed on the ground... About 2 feet wide - 2 feet 6 perhaps - on the ground. And the tube was vertical and perpendicular - and it didn't grow at the top or anything - and that was one of the unusual things about it. And this went on for several minutes and then died away... and then another one appeared about two hundred yards from me - then, in the corner of the field. This was a similar situation again lasting about the same time.

I've worked these fields for 50 years and I've never seen anything like it before. Nothing at all like this.

Dutton suggests that Bull was seeing an “unfocused” beam of energy, but the beam might have actually pushed the crop down. We will discuss this further in chapter 32.

30. Crop Formation - Symbolism and Messages

We can broadly split formations into three types: Circles, Graphic designs/ and symbolism and literal messages.

Several researchers argue that because some of the later Crop Formation designs are beautiful, they must be being generated by a benign agency, party or group. Whilst I have some sympathy with this suggestion, I think the truth is more complicated. Few researchers will come right out and say “it’s benevolent aliens doing it” – perhaps because there is so little evidence to suggest that this is true.

As with any symbolic design drawn by an unseen or unknown hand, we often have to guess what message, feeling or concept is being conveyed. Interpretations are subjective, although some Crop Formations do seem a lot clearer than others in their meaning.

In this chapter, we will look at some examples of designs and messages, but I refer the reader to other works (already referenced at the start of this section) for more information, thoughts and analysis.

Symbolism

“Swallows” - Milk Hill, Wiltshire, 4th Aug 2003

Some researchers think that the Crop Circles are created by a force or consciousness related to Gaia or “mother earth” and that she is trying to tell us something – perhaps that we should care “for the planet better.” (I will mention this idea again later.) I could easily fill a whole book with available photos of formations (mainly taken by Lucy Pringle and Steve Alexander!) which could be said to hold such a message. Here, I include one example:

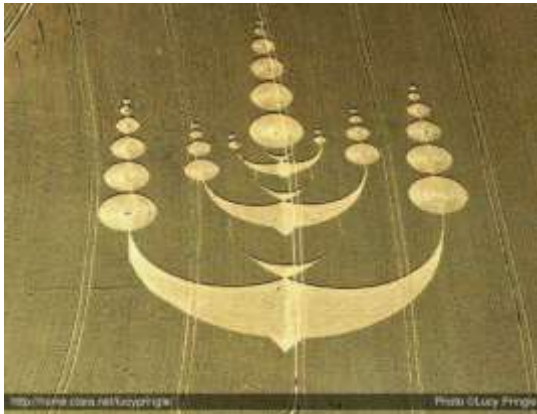

In this formation, some people will derive meaning from the arrangement of the circles and the number of them. Some will suggest that it shows the image of swallows, so the meaning is obviously related to that. Others will consider the date the formation was made, the geographical location and the orientation and try to associate meaning with those facts.

I agree that this is an aesthetically pleasing image – beautiful, in fact – though I could not be certain about its meaning, unless the creator of the formation told me what it was meant to represent.

Shoemaker Levy 9/Jupiter Crop Circle

For me, this next example does seem to be easier to interpret than some of the others I have become aware of. In 1997, [Kris Sherwood posted a very interesting article called “The Scorpius Hour of 1994”](#)⁹⁰³ outlining the design of Crop Circles which appeared around the time of the [collision of Shoemaker Levy 9 with Jupiter](#)⁹⁰⁴ – an event which took place between 16th and 22nd July of 1994, following the comet’s earlier fragmentation. Sherwood’s article discusses the formation which appeared on July 26th, 1994 at Oliver’s Castle, Wiltshire, UK. In the formation, the shapes of the letters “O” and “C” can also be seen - the initials of the place where the formation was.

In the article, Kris Sherwood points out some very interesting connections to the constellation of Scorpio over the time of this event and how a whole sequence of formations seemed to relate to astronomical events and “configurations” around the time of the cometary impact.



July 26th, 1994 at Oliver’s Castle (Photo by Colin Andrews)



[Jupiter’s atmosphere following impact of fragmented comet Shoemaker Levy 9](#)⁹⁰⁵

Was it the case that terrestrial circle-makers decided to use this astronomical event for a series of designs? Or was there, indeed, some type of symbolic communication occurring, between ourselves and some form of higher consciousness, trying to make us aware of a larger “cosmic picture” of some kind? Was it a reminder that life on earth could be extinguished by some type of similar cometary or asteroid impact, at almost any time?

Mayan Symbolism

For the first few years of the new millennium, it seemed that quite a few formations appeared which researchers claimed were based on Mayan Symbolism. Knowing little about Mayan Symbolism myself, for the purposes of this section, I will take those interpretations as being accurate (but of course as with all my other material, I am grateful to receive corrections or clarifications for anything I am mistaken about!)

I collected together several images for my Crop Circle Presentation, back in 2005 and I have included these in this section. I also found the same images on [a web page which also states these formations contain elements of Mayan Symbolism](#)⁹⁰⁶.



Formation showing Mayan Symbolism opposite Silbury Hill, Wiltshire 3rd Aug 2004.

Photo by Lucy Pringle

Like the following instances, it has been said the features of the design relate to Mayan Dates, according to some interpretations. In the image below, the central crescent shape is said to represent the Sun, and other features relate to dates in the Mayan Calendar. [It was claimed that the above formation was mechanically created across at least 2 nights, but these claims, according to Peter Sorensen are themselves hard to verify.](#)⁹⁰⁷ As we shall consider later, another agency – not aliens and not plankers/stompers may be creating these formations by non-mechanical means.



Left: Wheat formation estimated to be 320 feet in diameter, reported August 9, 2005, near Waylands Smithy, Wiltshire, England, stone circle and long barrow. Photo by Steve Alexander.

People argued that the 350-foot (approx.) diameter wheat formation shown left, which was reported on 13 August 2005 showed a complicated representation of Mayan Dates. As with the 3rd Aug 2004 formation, it appeared to be “added to” after its initial creation.

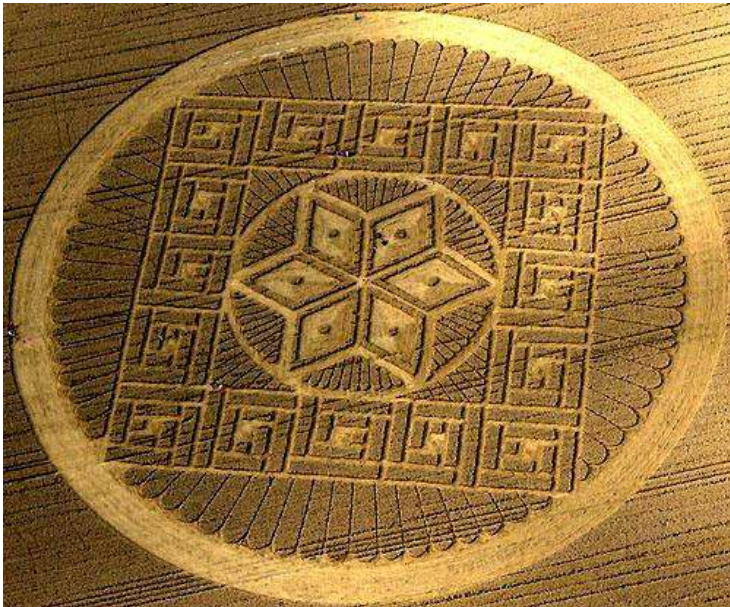

Woolstone Hill, not far from Uffington, Oxfordshire. Aerial photograph © 2005 by Jaime Maussan

Another formation with apparent Mayan Symbolism was reported in the UK Daily Telegraph newspaper on 08 July 2009⁹⁰⁸. The article read “350ft Crop Formation of an ancient Mayan symbol, said to be a sign of an impending apocalypse, has appeared next to Silbury Hill in Wiltshire.”



08 July 2009 – Mayan Headdress formation near Silbury Hill

The article stated:

The giant pattern - thought to represent a traditional Mayan head-dress - appeared next to the tallest prehistoric man-made mound in Europe last week.

Members of the Crop Circle community believe the mystic symbol is a signal of the end of the 5,126-year Mayan 'Long Count' calendar on December 21, 2012.

When considering these formations more deeply, it struck me as odd that a higher intelligence would want to show us Mayan Symbolism, supposedly relating to “earth changes” or “the end of the world” that would take place around the date given above. Back in 2005, I wouldn’t say I “totally believed” that these changes would take place, but I was perhaps less “jaded” about such ideas than I am now. Considering that Dec 2012 was over 6 years ago, as I write this in early 2019, it seems that any such earth changes were only incremental and I find it fairly easy to argue that human consciousness has not “elevated” very much at all. I find it easy to argue that human consciousness has actually “descended” to some extent.

In relation to the “2012” date above, we can agree that we saw a preponderance of Mayan Symbolism in crop formations before that date. However, I ended up asking myself why did we not see Hindu or Vedic symbolism? Why not a mixture of easily identifiable cultural or religious symbols? What have been the symbolic themes that have emerged since 2012? Have symbols which have repeatedly appeared in crop formations since Dec 2012 shown that “humans have failed the consciousness-raising test?” And in any case, what were Mayan symbols doing in the corn and wheat fields of the English countryside? Flipping that question around, I asked myself were

Christian symbols appearing in Crop Formations in fields in South America?
(I am not aware of any.)

Christian Symbolism

The first time I remember asking myself questions about why particular types of symbolism (Mayan) were appearing in formations, it was around the same time as I was giving a “Crop Circles” presentation in Watford, UK in September 2010. It was actually sometime after this I found [the headline “Jesus images ‘crops up’ beside motorway: Religious images spotted in fields by the M4”](#) in a UK Daily Mail article,⁹⁰⁹ which included the following image:



The text of the article included details about this unusual pair of formations, but there was no explanation for them:

The two almost identical circles, both 250ft in diameter, seem to portray Jesus Christ in an image resembling the world-famous Shroud of Turin.

The two Crop Circles [appeared] in fields of wheat either side of the M4 near Hungerford, Berkshire.

This is the only example I know of that appears to show overtly Christian imagery. Was the Crop Circle phenomenon interacting with me?

Crop Circle Messages

One of the aspects of Crop Formations that seems to be less frequently discussed are the subtle and not-so-subtle messages that some of them contain. In this section and the next one, we will look at some instances of these messages.

Milk Hill, 1991 - A message?

[A 2001 posting by Robert Boerman](#)⁹¹⁰ describes a peculiar incident in August 1991 when an American - Erik Beckjord, allegedly stomped/planked out the

words ‘TALK TO US’ in a wheat field (although I haven’t found pictures of his design). If the story is to be believed, it seems that he received an answer only 1 week later.... in Hebrew letters!



According to descriptions, the formation was 55 metres wide and the “letters” were 5.5 metres high ... hmmm....

The Boerman’s posting gives details of how, eventually, 3 translations were produced:

Translator	Hebrew	English
Michael Green	‘Phehthi or Ptah, Ea-cheche or Ea-Enki’	The Creator wise and loving.
Gerald Hawkins	‘Oppono Astos’	I am against acts of cunning.
Simon Burton	‘Ocului Nunc’	I’ve hidden at present.
Robert Boerman’s friend	‘Sewet Cham Anasim Gadasim’	A New Breed of People

The final translation was produced after viewing a mirror image of the formation.

[A further commentary by Ernest Moyer suggests](#)⁹¹¹ that the message is actually indecipherable – and that the other translators made too many assumptions or used too much guesswork in determining their results. He also felt that if benevolent enlightened beings were trying to communicate with us, the message would be more obvious so the idea of “viewing it in a mirror” (let alone writing in Hebrew to a largely English-speaking people) was too cryptic. I tend to agree with Moyer, because the first three messages seem rather “random.” We can also note that the formation is fairly simple – consisting of only two circles and then a set of perpendicular straight lines.

The 2001 Chilbolton “SETI Response Message”

This formation, which appeared on 20th or 21st August 2001, has been written about fairly extensively already. For example, [a comprehensive article by Paul Vigay describes many pertinent details about the formation.](#)⁹¹² Two formations appeared at the same time – about 200 metres apart, as shown in the photograph below. Crop Formation researchers Charles Mallett and Paul

Vigay both visited the formations, framed in a similar manner, in a wheat field. The “message” formation was about 60 x 25 metres. The “face” formation was about 50 x 55 metres. Both are framed by wheat laid down in an almost identical fashion.

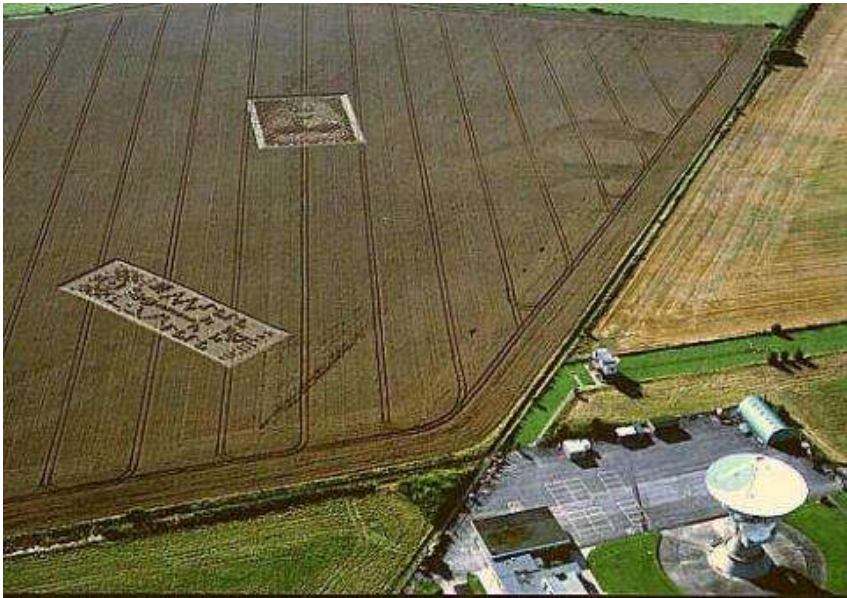

Having been “late to the party” in 2003, when I started to revisit the UFO/ET topic, I didn’t hear/read about this extraordinary “double formation,”⁹¹³ until about 2005. To this day it is, to my knowledge quite unlike most of the other Crop Formations (except, perhaps, the one we will discuss in the next section).



The smaller of the two formations is, without question, a face – a human, or perhaps a simian face. It is created from patches of varying sizes – surely quite a sophisticated way of creating a Crop Formation? Whose face was it? [Richard C Hoagland suggested it was the same face as the one seen in the famous Mars 1976 Viking Image](#)⁹¹⁴ (which I discussed at length in my “Secrets in The Solar System” book). However, as with the other messages, we cannot know for sure whose face is being shown – as we don’t know who

made the formation.

Of additional interest is the fact that these formations appeared right next to what appears to be a satellite receiving dish, but it is actually [part of an](#)

advanced weather radar system.⁹¹⁵ Hoagland usefully reports what the then manager of the facility said at the time of the formation:

According to Darcy Ladd, Manager of the Chilbolton Radio Observatory, in an interview with Colin Andrews, the image appeared “suddenly on the morning of August 14th.” According to Mr. Ladd, “No unusual activity was seen that morning, in the field or [in terms of] aircraft overhead, etc” According to the Manager, Chilbolton does have security cameras, but they are not equipped for night vision surveillance. The cameras captured “nothing unusual.”

Few researchers actually seem to treat this formation as being any different from the other formations and don't seem interested in its more direct interpretation as being of a face, rather than an abstract geometric design – or something relating to the position of planets in the solar system (as some other formations are said to have related to). For me, though, even more extraordinary is the other formation, which is drawn out in a “comparison graphic” below:

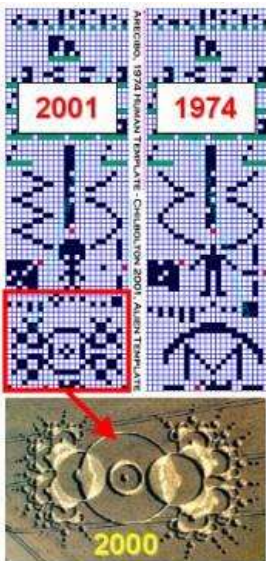

To explain this further, we must learn about a radio message that was designed by Frank Drake (who we mentioned in chapter 3) and sent out from the Arecibo Radio Telescope in Puerto Rico in 1974. The message – an idea of Gatekeeper Dr Carl Sagan - was an attempt to communicate with extra-terrestrials and was aimed towards the globular star cluster M13, 25,000 light years distant, in the constellation of Hercules. The message was encoded in a specific way (explained in more detail in Paul Vigay's article). The right-hand column/section of the graphic to the left shows how this message was essentially an array of pixels – a low resolution monochrome digital image or diagram – which showed details about humans, where we lived, and the type of equipment used to transmit the message. It included reference to our DNA, as well as the physical shape of our bodies (as can be

seen in the “stick man” about two-thirds of the way down the image on the right). We can see that the left-hand image has many similarities and quite a few differences – the most obvious of which is perhaps the “human” figure is no longer human-looking – it arguably looks like a grey alien. Also of interest is the lowest section of the image, which shows [a simplified version of another formation which actually appeared in the same field on 13 Aug 2000!](#)⁹¹⁶

Other researchers suggested that the authors of this message are showing us that they are in our own solar system, due to a part of the diagram which represents the author's position in the solar system being altered in their “response” message.

So, here we have a formation with a message which:

- Has unambiguous references to a message sent by scientists in 1974.
- Includes meaningful changes to that original message.
- Includes clear and specific reference to an earlier formation – in the same field!

Does this mean the formation was created by grey aliens? Not necessarily.

What I am trying to point out, again, is that this formation is very different to most or all the others that preceded it. To my knowledge, no one has claimed responsibility for these formations – and I am not surprised, because I find it difficult to accept that they could have been planned and then planked/board-stomped to produce the observed results.

Indeed, according to the words of Colin Andrews, as posted on Richard C Hoagland's site⁹¹⁴, Andrews seemed to agree:

*... The 'face' and the 'message' at Chilbolton presented different clues [from the previous Milk Hill formation]. The farmer, at my request, when harvesting the field, lowered his harvester cutting boom to approx. 1 inch above ground level. In my experience, this is an excellent method of finding underlay. What I found was VERY revealing indeed. Each pattern was set out first using a very accurate grid on which the designs were then formed or made. I will show photographs of the under lay later What we saw was a beautiful grid, all visible after the overlay of flattened plants had been cut and removed by the harvester. **There is no doubt in my mind that we have a different hand at work in these last three designs and IF it is people, then they certainly have military style precision and even possibly technology.** Too soon to draw conclusions but it's certainly damned interesting working through the increasing volume of data ...*

As the formation seemed to be a response to a message sent by the early SETI programme, it would have seemed appropriate [for SETI to comment on the "message" formation, which they did \(although that response is now tucked away somewhere and only easily available via the internet archive\)](#).⁹¹⁷ I quote some of this response below:

Despite the fact that many of the circles are known to be the work of pranksters, interest in Crop Circles has enjoyed a recent revival thanks to a pair of new patterns that appear in a field next to the Chilbolton Observatory in Hampshire, England. One is a modified version of the 1974 Arcibo message, broadcast in the direction of the globular cluster M13 in November of that year.

This is highly improbable. There is no evidence to suggest an other-than-earthly origin for these graphics. Some of the reasons why we are skeptical that this is a "signal" from afar are as follows:

If radio isn't their thing, why don't they simply leave a copy of the Encyclopedia Galactica on the doorstep of either the farmer or the radio observatory? They could arrange for a radio blast sufficiently powerful to reach every FM or TV set in a hemisphere, which would quickly convey far more information, and to everyone at once.

How come they look like us? Hollywood aliens always look pretty humanoid, but this is an anthropocentric conceit. Visit the local zoo, and you'll find

critters that share 3.5 billion years of evolution and a lot of your DNA. But they don't look like you - they look like fish, or alligators, or...

Although the author of this response is not named, it is probably the work of Seth Shostak. This matches Shostak's style of making flippant remarks and ignoring the main pieces of evidence. He expresses no interest in how this complex formation was created – he adopts the default “sceptic reductionist” position. [Richard C Hoagland has written about this in some detail, suggesting some reasons for SETI's behaviour, and some of the background to it.](#)⁹¹⁸ Hoagland implies (and I agree) that someone in the SETI programme (or someone closely tied to it) has “insider knowledge” regarding the truth about the UFO/ET question – and, perhaps the true nature of some of the formations.

“Alien Head” and CD Message - August 2002

As with the “Arecibo” message, I only came across this formation in about 2005 and I still think it is the most extraordinary Crop Formation I have seen and therefore was an obvious choice for one of the cover images of this book. It appeared near Crabwood Farm House in mid-August 2002, near Winchester, Hampshire and was reported on 15th August 2002.

This incredible image contains a binary encoded message in the disk – you can read it by decoding the sequence of 0s and 1's, from the inside out, (as a CD is read) into a set of ASCII characters, as shown below.

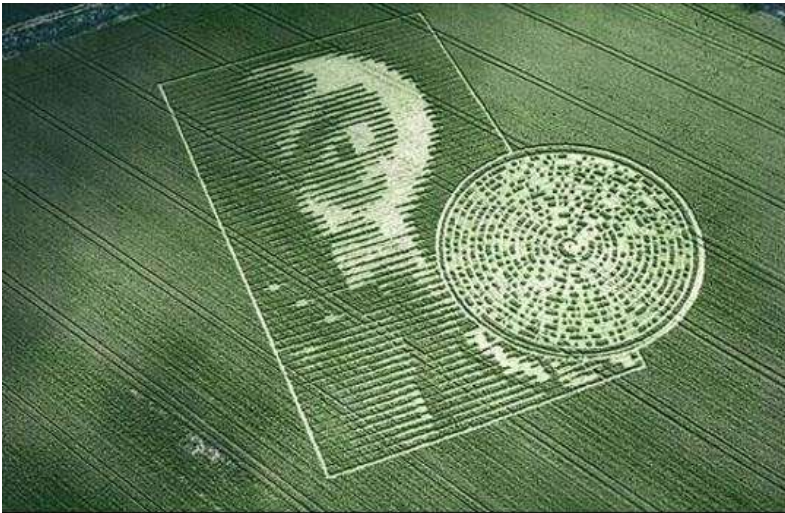

This formation was approximately 300 feet long and appeared on Crabwood Farm 14th/15th Aug 2002. (Some photos taken by Lucy Pringle)

Of course, this image “shook things up” – and was immediately characterised as an obvious hoax – due to the blatant imagery – and literal message it was made up of. This, of course, is quite ironic because sceptics are often heard to say “why can't these Crop Circle messages be in English?” As we will see, this one was! (And this only raises more questions!)

Other details in the formation include the appearance of the “head” itself – as that of a grey alien. Also, there is a line of three circles, each with an associated bisecting line, over to the left of the formation. [An article on the “Humans Are Free” website suggests this may be a reference to, or a representation of, the three stars in Orion’s Belt.](#)⁹¹³

The Message

The late Paul Vigay was one of the first people to decode the message and he has a [detailed analysis on his website](#)⁹¹⁹. He explains how we can read the message from the formation. The flattened crop segments are binary 0s and the raised crop sections are binary 1s. There is a sequence of raised/lowered crop segments, in groups of 8, with a “half-flattened” section of crop between each group of 8 (red blocks in the diagram below). This then forms a byte – and the decimal value of that byte can be worked out using standard binary to decimal conversion – that you can do on paper, or on most modern calculators.

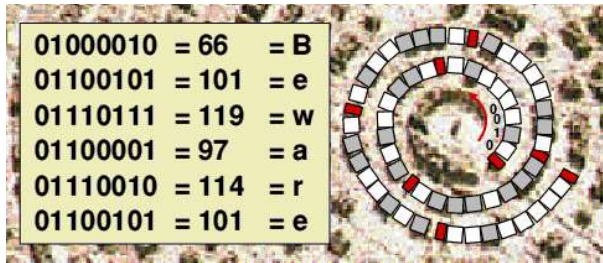

Raised/lowered crop represents binary digits – and bytes.

It was realised that the message was encoded in a similar way to data on a compact disc – which is read from the inside to the outside, as shown above. Putting all these things together, several people decoded the message. Due to some difficulties in clearly seeing the groups of “bits” from aerial photos, there was disagreement about the decoding of the message – some people thought there were errors in the message, but overall, there was strong agreement about most of the words in the message, which reads

“Beware the bearers of FALSE gifts & their BROKEN PROMISES. Much PAIN but still time. BELIEVE. There is GOOD out there. We OPOSE DECEPTION. CONDUIT CLOSING.”

The decoded message was [first published on Linda Moulton Howe’s site www.earthfiles.com](#)⁹²⁰, in a slightly different form. Vigay [summarised things thus](#)⁸⁴⁶:

I wrote a detailed analysis and decoding of the disc design. However, it was again my belief that this was an elaborate hoax, aimed at detracting from the true Crop Circles which were more subtle and contained mathematical and geometrical theorems. This formation was too blatant, ‘in your face’ and out of place with what I had come to understand from the genuine Crop Formations and their spiritual message. This view continued to be controversial but was generally agreed on by most serious Crop Circle researchers.

When I spoke to Paul Vigay briefly at the Dorchester Conference in 2006, he essentially repeated these sentiments. Though I respect Paul's expertise in many areas, perhaps he is missing something in his analysis, which I have already hinted at, but another researcher did an excellent job of addressing some of my thoughts about the message.

Researcher Maurice Osborn and some other people have pointed out subtle errors in the original "Earthfiles" translation⁹²¹ of the message, thus.

Osborn	Earthfiles
Beware the bearers of FALSE gifts & their BROKEN PROMISES. Much PAIN but still time. BELIEVE.	Beware the bearers of FALSE gifts & their BROKEN PROMISES. Much PAIN but still time. (Damaged Word).
There is GOOD out there. We OPpose DECEPTION.	There is GOOD out there. We OPpose DECEPTION.
COnduit CLOSING,	COnduit CLOSING (BELL SOUND)

Maurice Osborn, initially thinking the formation was a hoax, completed his own detailed analysis of the message therein, and [he explains some of this in a video he made](#).⁹²² (Osborn also explains the "Arecibo formation" mentioned in the last section). He suggests that the small differences, shown in bold above, are important.

Message Analysis

I very much liked his thoughtful analysis of the features of this message, and therefore have included much of his commentary below.

Notice how all of the letters in some of the words are capitalized, in order to add emphasis in some words... Let's examine what this message is actually trying to tell us.

The first sentence states "Beware the bearers of false gifts and their broken promises." This message is far too important to simply be telling us to be cautious of one another. Because this message appears to be of extraterrestrial origin, I believe that it is referring to the intentions of an alien race that could be offering us advanced technology and spiritual guidance. Although it does not specifically reveal whether false gifts have been offered in the past or will be offered in the future, it does say that those who offer the gifts have broken their promises in the past.

Since this is not common knowledge, it implies that secret communications have taken place between our government and extraterrestrials that have proven to be untrustworthy. This is telling us that we should be suspicious of any gifts that an alien race may provide and that we should not trust everything that they tell us. The second sentence says "Much pain but still time." Whoever wrote this is displaying compassion for human suffering, which they know exists on this planet. Although this does not indicate who is suffering, it can be assumed that the pain referred to here is caused by the bearers of false gifts and broken promises. However it does state that there is still time to overcome the pain.

The next sentence consists of a single word – "Believe." It is telling us to believe that there is still time for Humanity to end the suffering here.

The next sentence states “There is good out there.” It implies that there are good entities that can help us to stop the pain, although there is no indication of immediate help, we should believe that there are good entities that can help us.

... “We oppose deception.” This indicates the source of this message is coming from a group of beings that are concerned about the dangers to humanity [posed] by untrustworthy entities that seek to deceive us with false gifts. They are making it clear that it is their intention to oppose those who would take advantage of others through deception.

Osborn then argues that the final part of the message (“conduit closing”) refers to the closing of “a passageway or portal that enables the evil entities to pass into our world” and that “entities that are here are unable to leave and that no more entities can come into our world.” Osborn further argues that other versions of the message were translated in a way which reduced the emphasis on the “BELIEVE” word and also that the “Bell Sound” (ASCII character number 7) meant “end of message” whereas the correct version “,” (comma) implies there would be more messages to follow.

I would like to think that Osborn’s assessment is correct and the message was sent, in good faith, from a benign group or agency, especially when I consider what I have already covered earlier in this book – the possibility that Eisenhower really did meet with aliens in 1954 and make an agreement. Also, I have considered that both the Starchild Skull and the “Alien Interview” are very strong evidence that grey aliens are real and have been involved with human affairs in some way (and yes, this is exactly what abductees have said!) In both the Arecibo Message Crop Formation, and the “Alien Head” formation, we have again seen the occurrence of “grey-alien” related imagery. However, I must also entertain the “alien head” message itself is part of a larger psychological operation, which I will discuss more later. Whatever the truth is, I can say that I have not really seen another message like it since its appearance over 16 years ago (as I write this in 2019).

Responding to the Message

As an article on the YOWUSA website reports, [Maurice Osborn decided to travel to England to create his own “binary response message!”²³](#) Osborn has written several books about the UFO/ET subject and they are available on “Smashwords.” [On one of his pages there, he tells us more about his “response” message:²⁴](#)



In August of 2004, I and five other people from England placed a message in a Crop Formation at Market Lavington, England with the farmer's permission. It stated, "We welcome all who respect our free will. If you choose to help, then help us to help ourselves. There is good here too. We look for a reply." Although there has not been a reply to this message found in any subsequent Crop Circle formation, there has been a response. In September of 2008 at Avebury Down, England, an elaborate cross pattern was discovered in a crop

formation with a dot pattern next to it, that spelled out the word "Believe" in the same way as before.

In January 2019, I e-mailed Maurice Osborn to ask him how long it took him to make the formation. I also asked him if the "cross pattern," which he referred to as being next to the "Believe" response message he described, was the one shown below.



Large cross pattern and "bar code" in upper left reported September 28, 2008, in maize (corn). Estimated length is 700 feet. © 2008 by Tammi Paxman.⁹²⁶

Osborn replied:

To answer your questions, it took 2 full days of hard work in daylight to make our reply Crop Circle message. Also, I was unable to see "Believe" in the formation that you referenced of Christian symbolism. I wish you well with your efforts.

So, this gives us a measure of how long the "Alien Head" message might have taken to create if it had been "planked" – longer than 2 days in daylight. (No one has come forward to claim credit for the "Alien Head" formation, to my knowledge.)

In his "Smashwords" posting, Osborn referred to the response of "Believe" being present in the field near an "elaborate cross formation." However, it is

reported on the page, linked above, that the “bar code” message (seen upper left in the image above) actually reads “*Beware*.” I therefore wrote back to Maurice Osborn and asked him about this and he replied:

I am afraid that I cannot be of any further help with your investigation into Crop Circle messages. I am aware of the bar code next to the 2008 Crop Formation at Avebury Down that had “Beware” encoded in it, but I am not aware of anything else with the word “Beware”. I’m afraid that I cannot be of any further assistance.

I was disappointed with this response, considering what a comprehensive job he did on the original “alien head” message.

Osborn states on his “Smashwords” page that he had a horrible abduction experience in 2005 (three years after he made his “Crop Circles Decoded” video). I also note here that he has written a book about the Secret Space Programme – based on the non-evidential “disclosures” of Corey Goode⁹²⁷ – rather than more solid evidence (some of which I discussed in my previous “Finding the Secret Space Programme” book).

Location of the Formation

We can see from the image here, that the “Alien Head” formation appeared quite close to a telecommunications mast⁹²⁸ (which appears to have microwave transceiver dishes on it).



Formation was near a telecommunications mast.⁹²⁹

We saw with the Arcicibo message formation that it was in a field right next to the Meteorological Radar station. I don’t know if this is significant or not, but I found this fact interesting (both these structures are involved with beaming microwaves).

Motives and Machinations

I asked Crop Circle expert David Cayton what he thought about this formation, and whether he had visited it. David said that he had not been able to visit this formation, but was in agreement with Paul Vigay about it, in that it was a hoax. He suggested

The wording, how ever one interprets the actual words, is ironic, especially the words “ We Oppose Deception” and reference to “False Gifts”!! A great ‘send up’! The ET’s, in my book, would never do something as obvious and corny as this formation!

David therefore felt that some formations have been created by ET’s but not the “alien head” formation. David also said:

...it is pretty clear that it was created by the accomplished planking team of John Lundberg & Co. [That is, the “Circle Makers” group.]

Richard (Not Hall) and Judy (Not Wood) Show

David's reason for attributing the "Alien Head" formation to Lundberg and co. was at least partly because, a few weeks after it appeared, [the Circle Makers were tasked with creating a formation near Edinburgh, of a similar size, for the "Richard and Judy" UK daytime TV programme.](#)⁹³⁰ David argued that this formation, too, was quite complicated and so it would have been possible for them to create the "Alien Head" formation.

David noted:

They simply worked from one side, going across in plank width rows in straight lines, working all by numbers, leaving some places on each row as standing crop, thus building up the image bit by bit, much like the 'Raster' scan on a CRT! They admitted that the hardest part was Judy's hair!



Circle Makers' 2002 "Richard and Judy" image.⁹³¹

David also acknowledged, however, that "the message disc was constructed somewhat differently."

(One could observe that the "alien head" part of the Crabwood image was formed with a type of "raster scan"). The Circle makers website notes that the "Richard and Judy" project was kept secret and there was a large amount of media attention given to it on the day [it was shown on TV](#)⁹³². I haven't seen a similar set of media articles about the "alien head" formation, however.

Considering David's thoughts carefully, it is worth considering the relative complexity of the "Richard and Judy" (RJ) formation which we *know* was planked, with the "Alien Head" (AH) formation, which no one has claimed to have planked. Even at a basic level, the RH formation is simply a "copy" or representation of a single photograph. It has no embedded message. Its construction is also fairly simple – proceeding across the field in straight lines, starting and stopping the stomping/planking at the correct points.

However, I would be extremely sceptical of anyone who claimed they could plank (accurately) over 150 ASCII characters (that's over 1200 bits), so that the message was laid down accurately, in a spiral, so that Paul Vigay and others could successfully decode it...

Who composed the AH message and wrote it, to include and convey the subtleties Osborn highlights in his analysis? Do you think a group of plankers dreamt this up?

The appearance of the AH formation divided the Crop Circle research community precisely because the formation was so intricate, and so not at all likely to have been "planked," due to the time it would have taken and the size of it. However, it also could not "have been made by aliens" – because it was "too blatant" or "too obvious a message." This, to me, therefore, opens up a

third possibility – involving the use of “advanced black technology” to confuse, confound and create conflict.

Operation Black Jack (Not “Blackbird”)

Earlier, I suggested that the AH message might be part of a psychological operation (psy-op), even though I’d like to believe it was a genuine message from a benign group of beings (terrestrial or extraterrestrial). Sometime after I had first talked about the AH formation in presentations, I came across reference to another embedded/encoded message in a very unusual place - a “cartoon strip” in the UK Daily Telegraph newspaper. The encoding of this message is, superficially, similar to the “Alien Head” message but it used hexadecimal codes rather than binary. Was it the same agency (i.e. the intelligence services) behind the message?

The message appeared in a cartoon strip called “Operation Black Jack” which was about an imagined “nuclear” terrorist attack on London. One segment of the story shows an ID card from a member of “The Union of North America” (and the inclusion of this fictitious state raises its own questions)



Part 4 of Operation Blackjack – “The events portrayed here are imaginary”⁹³³ (It appears this same slide/image appeared in “Part 5” too⁹³⁴)

The embedded messages were picked up by some “Reddit” posters⁹³⁵.

As you can see, there is a very long number across the centre of the ID card, showing the digits (which I’ve copied down in pairs)

74 68 69 73 20 69 73 20 6e 6f 74 20 73 69 6d 70 6c 79 20 66 6f 72 20 65 6e
74 65 72 74 61 69 6e 6d 65 6e 74

If we then take the digits as pairs of hex digits⁹³⁶, each representing an ASCII code⁹³⁷, then we can look up/convert the code into an ASCII character. This is made easier by online pages which do this conversion for us⁹³⁸. The result is shown below.



The decoded Hex/ASCII message embedded in an imaginary Daily Telegraph Story So, the encoded message reads:

this is not simply for entertainment

The reddit thread also stated that there [was another slide](#)⁹³⁹ (shown below) which was deleted from the “comic strip” presentation, though the actual image file (JPG) was stored on the Daily Telegraph’s server for some time:

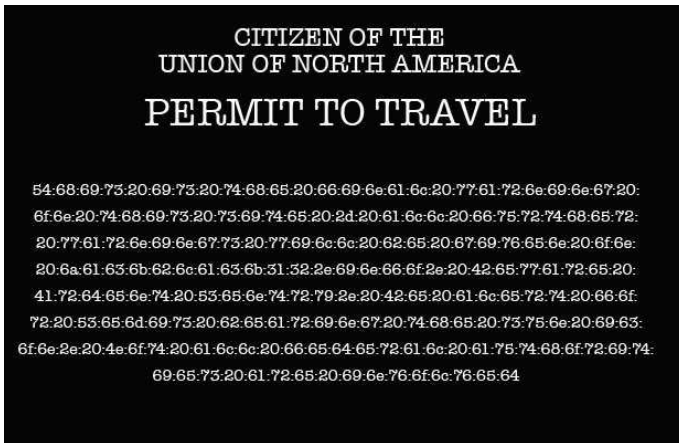

Original (deleted) Slide 17 of Part 4 of Operation Blackjack.

We can note that this image, again refers to the Union of North America. Using the same “ASCII hex pair” decoding method, described above, the message that appears is:

This is the final warning on this site - all further warnings will be given on jackblack12.info. Beware Ardent Sentry. Be alert for Semis bearing the sun icon. Not all federal authorities are involved

Hex to ASCII text converter

Enter 2 digits hex numbers with any prefix / postfix / delimiter and press the Convert button (e.g. 45 78 61 6d 70 6C 65 21):

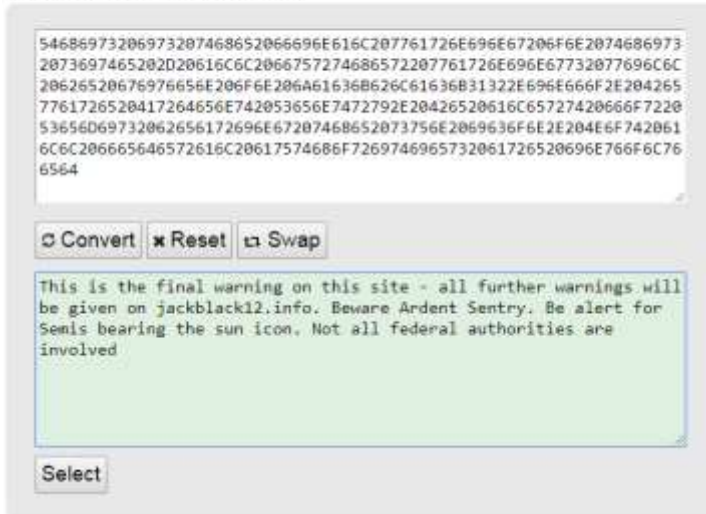

Decoded message from the deleted Slide 17.

As can be seen, the message mentions a website - <http://jackblack12.info/> this is currently not showing any content, but, as you can probably accept, they can use this website to track who has managed to find and decode the original message...

It seems fairly clear to me that these encoded messages are somehow related to intelligence service activities. Can we therefore suggest that the same “fingerprint” or “signature” is present in the AH message, thereby suggesting the same agency was involved in writing and encoding this message?

Summary/Conclusion

The complexity of Crop Formation patterns has increased in the last 20 years and there are many factors which rule out board-stomping as the sole cause.

There are at least three different and distinct types of message or concepts that have appeared in the formations:

- The “shape” and “graphically encoded” symbolism – e.g. the Mayan symbolism and even [illuminati symbolism](#)⁹⁴⁰
- Geometric or mathematical relationships (which I have not discussed in this chapter, but [an example of one such formation is where the ratio of \$\pi\$ \(pi\) was encoded in the design](#)⁹⁴¹).
- More “literal” messages – such as the “binary” encoding used in the “Alien Head” formation and the “Arecibo response” – which seem to be far rarer.

Do these three types of messages have three different types of authors?

31. Energy Effects and Residual Effects in Crop Formations and Elsewhere

This chapter is based on an article I originally posted in Dec 2015, following information given to me by David Cayton and Robert Hulse.⁹⁴² That article, in turn, was based on a short video/PowerPoint presentation I made in 2010 which illustrated a connection between characteristics related to the formation of Crop Circles and the evidence pertaining to the destruction of the World Trade Centre complex on 11 Sep 2001⁹⁴³.

Before going into a little more detail about the WTC destruction, I want to include some information which I think is relevant to the way formations are made. Please keep the title of this chapter in mind as you read the next few subsections.

Crop Formation Considerations

Geology and Sacred/Ancient Sites

Several Crop Circle researchers have noted that the underlying geology of an area could be a significant factor in dictating where formations appear. An interesting posting by Glenn Broughton and Steve Page notes⁹⁴⁴ that many formations appear in southern England – over the biggest Chalk Aquifer in Europe. They also note some formations seemed to appear along two of the ancient British pathways - The Ridgeway and The Icknield Way.

John Burke of BLT also felt the role of the aquifer was significant in Crop Formations⁸³⁰:

Crop Formations in England overwhelmingly appear over shallowly-buried parts of a giant chalk aquifer. England has the world's deepest chalk aquifer (the white cliffs of Dover are a view of one side of it). They also have some of the world's greatest seasonal fluctuations of water levels—up to 100 feet. Was there anything about this which might attract plasma? As it turned out, there was. Water percolating through porous rock—any kind of porous rock—creates electric charge. This occurs by a process called “adsorption,” in which electrons are stripped off water droplets as they move through rock pores, leaving a net negative electric charge behind on the rock and a net positive charge on the water which drains through.

An experiment using 2 cross-connected tanks of water, first conducted by Kelvin, and shown by Walter Lewin in one of his lectures, illustrates this process taking place⁹⁴⁵. An associated diagram is shown below:

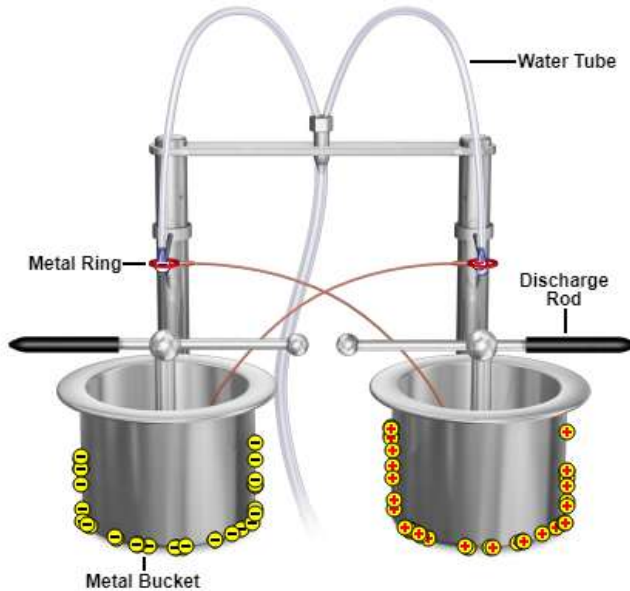

Kelvin Spark Generator⁹⁴⁶ – If a spark gap is set between the lower tanks, a spark will jump across between the two rods, once a sufficient voltage has built up, as water flows down from the top.

Burke continues:

With calcium carbonate (the mineral which makes up chalk) there is a chemical process when the water dissolves some of the mineral, which further reinforces this same charge separation. Wherever charge separation occurs in a body which can conduct electricity, electric current flows and generates its own magnetic fields. We measured these ground currents and their changing magnetic fields in 1993 at Silbury Hill, long the center of the most intense Crop Formation activity in the world.

Burke also made measurements of these fields before and after Crop Formations appeared:

In one particular field in England which has nearly annual Crop Formations, our team measured the kind of magnetic fields one would expect to accompany such electric ground currents; four days after taking these measurements a major formation occurred there. Follow-up fluxgate magnetometer measurements, taken four days after this sixty-foot dumbbell appeared, showed that the magnetic readings and the currents which produced them had vanished. This is not unlike the discharge with that more powerful plasma—lightning. In the case of lightning, ground current attracts the airborne plasma, and when the plasma (the lightning bolt) hits the surface it neutralizes the ground current.

Burke also argues that the location of Crop Formations in the USA and Canada bore a similar relationship to the location of local aquifers.

Could it be the case that the water movements through the aquifer create a subterranean electrostatic field? Is it this that is exploited by “technology” used in creating some formations, as was done with Hurricane Erin on 9/11?



Map showing areas of chalk aquifer in Southern Britain.

Is it the case, then, that the aquifer holds some type of poorly understood “earth energy,” or simply, as Burke and others have suggested, they could hold some type of static electrical charge? Did the ancient monument builders know how to exploit this energy/charge to their advantage, using carefully placed standing stones, as Burke suggests in his book [“Seed of Knowledge, Stone of Plenty.”](#)⁸³² Is it possible to exploit this subterranean charge or field for “other purposes?”

Residual/Ongoing Effects in Crop Formations

We have 2 types of evidence which show ongoing effects where Crop Formations have been made. Firstly, ongoing effects have been observed in the following years growth of crops - [as photographed by Busty Taylor](#)⁹⁴⁷.

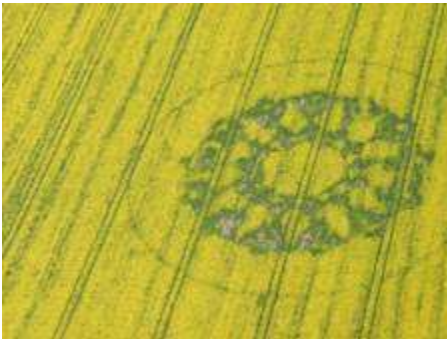

West Stowell. Wiltshire. May 1st 2004



Avebury Avenue, Wiltshire, May 1st 2004

Secondly, thanks to information supplied by David Cayton and Robert Hulse, [in a video they made in 2002](#)⁹⁴⁸, we have evidence of residual energy effects of some kind, in the [Pewsey Nautilus Formation formed in July 2002](#)⁹⁴⁹. Entering this formation, David Cayton was using a Geiger counters - designed to detect levels of dangerous ionising radiations - principally, energies from Gamma, X – rays, Alpha & Beta. (David was trained in the use of these by the U.K.

National Radiation Protection Board - NRPB at their Northern Centre in Leeds.)



Reading about 1 on the scale



Reading goes off the scale on the lowest setting of the instrument.



← David Cayton holding instrument to measure Ionising Radiation.

Also, David Cayton related how the small circle, seen to the right of the main formation in the image above, was originally *a smaller version* of the main formation, before someone came and trampled it down!⁹⁵⁰

Fortunately, an aerial photo was also taken⁹⁵¹, showing this “mini formation” (see right).



David Cayton also experienced residual energy effects near a 1998 crop formation alongside Silbury Hill

(see image below), which he initially thought was a planked formation. He casually pointed a Geiger Tube (similar to that shown above in David’s right Hand) into the small diameter swirled circle nearby, as he walked back to the car park. This destroyed the inner workings of the GM Tube, and it could not be repaired!

David Cayton writes:

The Instrument immediately responded rapidly and the counts per sec shot up to over maximum on the scale, over 2000cps, with the audio warning tone rising to a loud screeching sound with complete saturation! Needless to say, I was more than a little perturbed by that event! If indeed, I was detecting ionising radiations, it would be VERY unhealthy to linger close by, or into the small swirled circle!

Later on, over a few years, including the experience within the 'Nautilus' formation at Pewsey, I had recorded Geiger counter responses of various levels in about 4 or 5 formations which we believed were NOT man made, together with my dowsing rod deflections, neither of which I EVER experienced within the planked formations!!!

After a while, I came to the conclusion that I was NOT detecting harmful ionising radiation but most likely some type of magnetic force, probably an EMF source of some kind? One of the reasons for this (as I demonstrated in the full Documentary CCTHT) was that when the instrument was displaying a reading above normal background gamma radiation, no matter where I positioned the Geiger tube, either touching the crop, at waist height or holding it high above my head, the reading remained constant at the **same level!** If there had been some surface contamination upon the crop plants or in the soil, the readings would decrease as I raised the probe up and away above the crop floor due to the physical effect of the 'inverse square law'. When I phoned the NRPB HQ at Didcot from the Pewsey formation that day, Chris asked me this and then asked if I was close to overhead power cables or an electrical transformer? In other words, he was baffled and could only suggest some type of EMF was upsetting my instrument... he had no other ideas!

Now, the other important and relevant factor in all of this, which in itself suggests that there was **no residual** surface contamination of any sort at crop level. It should be noted that the odd remote 'electrical field' affecting my Geiger Counter was transitory and appeared to **be above** and also a few paces **beyond** the periphery of this formation!

During the increased reading, I walked a few paces down a tractor line, completely out of the circle, until the reading suddenly dropped back to normal background level, just like a switch being thrown! I marked the spot, called Robert over with his camcorder. After continuing to walk beyond the marked spot, we did an about turn, and with camera running, he then followed me looking over my shoulder with camera directed onto the instrument. When we reached my marked spot, we fully expected the instrument to immediately and rapidly recommence reading the same high responses as before? **NOTHING** happened, the reading merely indicated once more the normal background level and this continued right back into the Crop Formation!!!!

I had on another occasion, in a different formation, stood alongside Paul Vigay and 'compared notes' so to speak, as he operated one of his EMF meters with my fluctuating Geiger counter readings, when he was noting the rise and fall in his readings! Again, this was a Crop Formation we judged to be 'genuine'!

Perhaps this accounts for the regular reports of the failure of cameras, cell phones and the like and also the reports of people feeling either very nauseous or even energised in some way.

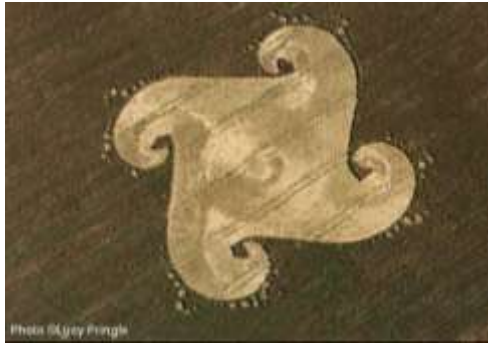

Formation near Silbury Hill – 22nd Jul 1998 - a small circle near this was found to have an extremely strong effect on a radiation detector.

Energy Effects Seen in Laid Down Crop?

In a short film given to me by Robert Hulse⁹⁵², there is some interesting footage taken in a wheat field at Etchilhampton, showing some unusual seed head bending and stem lay. Hulse and Cayton describe how this seems to be the result of some kind of “energy flow”. Again, high Geiger counter readings were detected which changed in level from position to position. A chap, called Francis from Belgium, with his girlfriend, also used the Geiger counter for a while and he witnessed his own odd instrument readings.



Bending of Seed Heads follows the pattern of the circle- seed heads bent in opposite directions but both in the direction of the formation of the lay.



Here, it is shown how the Stem Springs Back when bent forward gently.

So once again, what energy or force has warped/bent the seed heads, in a pattern, without breaking the stems....?

Dowsing the Residual Energy

Quite a few Crop Circle researchers have used the dowsing technique to try and gain more information about the circles themselves. Dowsing has a long history and that is perhaps because the results it gives are more often reliable than unreliable. In November 2016, I interviewed David regarding some UFO cases and, around the same time, [he gave me a video he had made about using dowsing rods over crop stem samples from formations he had visited, which I digitised and posted on my YouTube channel.](#)⁹⁵³

David Cayton visited a formation made in Oilseed Rape, on 20th April 1997 in a field below the ancient hill fort of Barbury castle some six or seven miles south of Swindon in Wiltshire. He made observations and checks and verified the crop formation was not mechanically made, noting, for example some expulsion of plant tissue from some of the stem nodes. David stated that he wasn't aware of dowsing done in formations made in Oil Seed Rape, so he decided to try this himself. He observed deflections of the rods within the formation.

He then took two stem samples – one from inside the formation and another from the edge of the field, 150 yards from the main formation.

In the video, shot about 3 months after he collected the samples, Cayton notes that the sample from the edge of the field caused no rod deflection, but the sample from within the formation caused the rods to deflect into a position that was parallel with the orientation of the stem. This therefore suggested the stem itself held some kind of residual energy.

Harrier Jump Jet Incident, 1987

An unusual event occurred in 1987 when a new Harrier Jump Jet crashed into the sea, having flown over Wiltshire in the exact area many Crop Circles appear. Colin Andrews wrote this incident up in the [June 1988 issue of Flying Saucer Review](#)⁹⁵⁴, in which he writes:

Complete mystery still surrounds the top-secret British Harrier GR5 jump-jet aircraft which, pilot-less, flew on for over 500 miles and eventually crashed into the Atlantic Ocean off the south coast of Ireland on Thursday, October 22, 1987. The machine had taken off from Dunsfold in Surrey on a test flight at 16.59 hrs. with Pilot Humphrey Taylor Scott at the controls. Six minutes later, and without any hint of an emergency from its pilot, radio contact was suddenly lost over Wiltshire to the west. The last radio message was a routine one, to air-traffic controllers at the top-secret Boscombe Down Air Force Base near Salisbury, Wiltshire.

Colin continues:

Despite a huge search operation, involving aircraft, shipping, life-boats and even mountain-rescue teams in South Wales, no trace of the pilot could be found. Then, on Friday, October 23, a gamekeeper, Mr Ken Pitman, came across the body of an airman lying in a field near the village of Winterbourne Stoke, near Stonehenge, in Wiltshire...The location of Winterbourne Stoke already meant something to me, for it was in a cornfield near that village that a set of four mysterious circles of “swirled”, flattened indentations had been found on Saturday, August 22, only eight weeks earlier.

9/11 and the Destruction of the World Trade Centre

I have already referenced research conducted by [Dr Judy Wood into the destruction of the World Trade Centre](#)⁶⁷⁶. This research was first included in a “Qui Tam” court case in 2007 against various companies contracted by the US Government to investigate the events of 9/11 from a scientific standpoint⁷⁷³, then it was compiled into a comprehensive textbook²³¹. The book proves beyond any reasonable doubt that the WTC Towers did not burn up, nor did they slam/fall to the ground. They turned mostly to dust in mid-air.

Ongoing Effects at and near the WTC Site

Not only was the dustification of the towers observed, there were “residual effects” at the former WTC lasting many months – years even. In Dr Wood’s book and on her website, she notes, for example, that dirt was trucked *into* the site immediately after the demise of the buildings. Dirt was also trucked out. This process seemed to be going on for several *years*. When I visited the site in 2008, I saw that the streets were regularly and thoroughly being hosed down, as was a pipe being dangled from a crane.



NYC Streets near WTC site – being hosed down on 17 Jan 2008 (Photo by Dr Judy Wood).
I wrote more about this in my book “9/11 Finding the Truth”³⁵³ and have discussed it in presentations I have given.

Banker’s Trust / Deutsche Bank Building – Opposite WTC

The Banker’s Trust building was opposite the WTC complex and, as seen in the left-hand image was badly damaged during the WTC’s destruction. The building was repaired, but not long after, underwent a piece by piece demolition/dismantling – over a period of several years – by a company (John Galt) that had never taken down a building before.



Soon after 9/11/01 (above)
and
then on 28 July 2006 (right)



[Several strange events happened – including a fire which killed three people.](#)⁹⁵⁵

Why repair a building then dismantle it? The evidence in Dr Wood’s book and presentations suggests that materials in the building were “degrading” – for example, steel beams were rusting excessively. What could cause this?

Levitation Effects on 9/11

Dr Judy Wood has shown that some type of levitation effects were occurring (in isolated incidents) during the destruction of the WTC. Also, First Responder witnesses such as Michael Macko and Photographer David Handschuh reported levitation effects:

Michael Macko: I realized I couldn't get out from under the collapse. I dove under an ESU truck that was facing north on the west side of West Street. I dove under that



This police car is one of several that were found, inverted, near the WTC site.

and waited for the building to come down. When the building did come down, I actually thought I was trapped, and the truck was blown off me, pushed off me, I guess. It was not there. At that point I was just really shocked and didn't know what was going on at that point. I didn't know—I was really, really shocked.

David Handschuh:⁹⁵⁶

When the south tower came down, I was across the street and I picked up the camera just out of habit and something in the back of my mind said "Run! Run! Run!" and never in 20 years of shooting in New York had I run from an assignment... and as I hit the corner of Liberty Street, it was almost like being picked up by a tornado... the black cloud had substance it was like night but it had had a solid feel to it... It was like gravel - hot gravel and it just picked me up and tossed me about a block... One second I was running and the next second I was airborne...

Apparent Heating but Lack of Actual Heat on 9/11

Dr Judy Wood has shown many examples of evidence of what looks like high heat⁹⁵⁷, but adjacent to evidence of little or no heat, as seen here. There is a peculiar wilting of doors and deformed window surrounds on this car on FDR Drive. But the rear end is in good shape, with an inflated tyre...



Also, we saw people who

were covered with dust, due to their proximity to the WTC destruction, yet not one of them was burned.

WTC Dust – Iron Rich Microspheres

In chapter 28, I mentioned how microscopic iron spheres had been found in some soils sampled from within Crop Formations by W.C. Levensgood. What many people don't know is that similar spheres were reported as being found in WTC dust. However, their presence was falsely attributed, in a disinformation exercise, to the use of thermite in the destruction of the WTC. Both Dr Wood and I have written and talked at length about why the “thermite” explanation⁹⁵⁸ cannot be true. I have also written about the main proponent of the “WTC thermite theory” – Dr Steven E Jones, who did research into an *energy phenomenon* known as Muon Catalysed Cold Fusion⁹⁵⁹.



Iron-rich spheroid from the USGS Particle Atlas of World Trade Center Dust.⁹⁶⁰ This 20 μm diameter sphere is comparable to ones found in the Crop Circle Soil Samples

Comparison of WTC 9/11 Evidence⁹⁶¹ and Crop Circle Evidence

Now that we have covered additional effects seen in crop formations, we can compile a table from the evidence discussed above and that which was discussed in chapter 28:

Effect	Crop Formations	WTC
Appearance of significant heating, but nearby evidence of no heating	Crystal growth in Soil (Smectites), Crops undamaged	Melted or “burning metal” near or next to unburned paper
Anomalous Tiny Iron Spheres	Magnetised Iron Spheres found by WC Levengood	Iron Rich Microspheres found by Steven E Jones
Causative process or mechanism not visible	Flattening of crops	Destruction of buildings
Levitation / Lifting of objects and people.	Witnesses / Researchers levitated after Crop Formation (Pat Delgado, Freddy Silva)	Witnesses levitated or experience levitation effects (David Handschuh, Rene Davila), and objects (cars, fire truck) inverted
Ongoing effects/changes	Apparent Radiation or EMF Readings after formation, Crop Formation patterns seen in following year’s crop growth	Residual fuming in ground, rusting of girders esp. in Bankers Trust

Conclusions

It seems from the evidence here that there are definitely residual energy effects associated with some Crop Formations. It does not seem possible that such significant residual effects could happen as a result of actions taken in mechanically producing a formation.

This energy causes selective changes in materials - some of which are subtle. Some of the changes mimic those caused by high heating.

Is it too much of a coincidence to suggest that some lingering effect from the circles formed in 1987 had some kind of effect on the Harrier jump jet - causing the canopy to be opened and the pilot to exit the aircraft? Or was this just an astounding coincidence? What is clearer is that there is a strong military presence in that region of England so it’s anyone’s guess as to what they know about these incidents and the technologies that are very likely at work in producing some of these phenomena.

In considering the “9/11 research factor,” as I did in the final part of the “UFO/ET” section of the book, no crop circle researchers that I know of have described accurately the way in which the WTC was destroyed, let alone have they mentioned or discussed the evidential similarities that I have covered in this chapter. For example, Nancy Talbot was sent a WDTTG book (by me) in 2015 or 2016, but there is nothing on the BLT research website and I have never heard her publicly comment about this research. The same can be said of Colin Andrews.

32. Crop Circle Technology - and Cover Up

In “Finding the Secret Space Programme” I, like other researchers argued, based on the available evidence, that secret propulsion and energy technologies have been developed and suppressed. When studying this same evidence, it also becomes obvious that considerable effort has been expended in continuing the suppression, in subtle and not-so-subtle ways. For example, if people can be ridiculed or discouraged from discussing the development of very advanced technologies in the context of UFOs/aliens, then that is a form of suppression or cover up.

Perhaps some researchers find it too difficult to accept that this same situation exists with Crop Circle research. Also, when it relates to weaponisation of technologies, which can be used to harm people, many researchers apparently don't want to discuss this – because they are more focused on the (apparently) benign or spiritual aspects of the phenomenon, and want to think more about enlightenment and expanded consciousness (discussed in brief later).

Crop Circles ‘created using GPS, lasers and microwaves’

[In the UK Daily Telegraph on 01 Aug 2011, a short article - by Nick Collins, Science Correspondent⁹⁶² - with the above title appeared.](#)

Crop Circles are now made using lasers, microwaves and GPS technology to create ever larger and more elaborate patterns, scientist claims as days of using planks and rope long gone.

It is probably unrelated, but this article appeared during the first few months after the release of Dr Judy Wood's “Where Did the Towers Go?” book, which mentioned several of the points I made in chapter 31. Missing from the article was any mention of who possessed the technology that was described. Also missing was any discussion like the one I had in the previous chapter – showing evidence of any specific unusual effects this technology can create.

We have, of course, mentioned the possible or likely use of microwave beams (or something similar) in making Crop Formations. We can also note that, by the mid-1990s, handheld GPS units (such as those made by Garmin) were starting to become available. We also know that these units were not as precise in their readings as those used by the military.

Roy Dutton and a Line Scanner?

We mentioned Roy Dutton in chapter 29. Dutton has also studied the Crop Formation phenomenon in considerable depth. He had also noticed the “swirling” or “spiral” characteristic of some formations, that we mentioned in chapter 27. Roy Dutton, a British retired Aerospace Engineer (RD) [was interviewed by Richard D Hall \(RDH\) and he talked about his work in trying to understand a non-mechanical crop formation process.](#)⁹⁶³

RD: First of all, I had to satisfy myself that what was producing these spirals was not a plank or roll or anything like that. These plants were genuinely

bent without breakage... beautifully inscribed into the crop. Busty Taylor and Colin Andrews provided me with data - photographs and drawings ... measured drawings, showing how the plant was swirled and also from Busty Taylor some very good overhead shots of small circles ... scattered around some of the bigger formations. I then began to look to see what pattern - what mathematical relationship - could be applied to these things, which might explain how they're produced...

RDH: When you looked at that pattern you saw that it was made of a series of discrete, individual sweeps.

RD: That's the first clue. They were generally... spiral strips.

RDH: So, you see a sequence of spiral strips, throughout 360 degrees... The theme that you came up with, was that it was a line scanner...

RD: We can analyse the swirl pattern by looking to see what the relative vector is outwards and transversely... it looked as if they'd been formed by something going outwards from the centre of the formation - at a steady speed - whilst something else was going around at an increasing rate as it went further out...

Dutton demonstrated his idea in a model and suggested that it was possible to create any pattern with a beam which would move outwards from the centre while some type of “directed beam” assembly rotated quickly. Dutton concluded from further studies of different spiral patterns found in different formations that “this was undeniable proof that an advanced piece of scanning technology was being employed to produce those wonderful patterns.”⁹⁶⁴ Dutton went on to state that any beam would have had to come down vertically onto the crop and it would have a heating effect. Importantly, he states that it would have to have both heating energy (like a microwave beam) and mechanical energy to bend the crop stems. Dutton proposed that a “microwave or high-frequency beam of gravitational radiation, which would have the effect of actually distorting and pushing down the plants. Importantly, Dutton then states:

It seems to me if someone's got that kind of technology, it would be the simplest thing in the world, I think, for them to link their computer graphics system up to the projectors – [there] might be more than one projector - and they can create any picture they like in the crop. It didn't have to be spiraled circles - it could be a program to flatten the crop in straight lines.

I think Dutton is absolutely right...

Nick Pope, Crop Circles and 9/11

In relation to suppression, it wasn't long after the appearance of the “Alien Head” (and “Arecibo Message”) Crop Formations for that matter that we had former government worker and UFO commentator/researcher Nick Pope saying, in November or December 2002⁹⁶⁵:

*I had to **refute** the bizarre idea that the formations were caused by **the testing of space-based laser or directed-energy weapons**, and dispel suggestions that media coverage of the issue had been stifled by use of D-Notices.*

This statement was included in an article on Colin Andrews' website (and

elsewhere). Andrews himself was, of course, involved in at least one military operation – Operation Blackbird – in 1990. It is very unusual in that not many people were using the term “directed energy weapon” in 2002, let alone in relation to the creation of Crop Formations. Why is it then, that Mr Pope needed to *refute* ideas associated with *directed energy weapons* being used in the creation of some crop formations?

Let us now study Mr Pope a bit more...

“Paid Spokesperson”

Nick Pope has been on the UFO Speaker Circuit since the mid to late 1990s. I first wrote to Nick Pope in about 2005 and he was very polite and quite helpful. At the time, I was quite surprised he responded to me. I briefly spoke to him in 2006 at a conference, but he seemed quite reserved and very shy and I remember thinking that he did not seem to “mix” with people at the conference.

Since 2006, I realised that Nick Pope was not telling the truth about certain things and some of his statements were contradictory. Since then, I have come to realise that he is not going to tell people the whole truth.

In chapter 31, I showed some physical characteristics and evidence connecting the events of 9/11 and Crop Formations. What does Nick Pope say about the events of 9/11?

[Nick Pope was asked in an interview by Anthony J Hilder to give his thoughts about the events of 9/11 and why the USA was “at war with Afghanistan.”](#)⁹⁶⁶

Pope responded thus:

We are not at war with Afghanistan. We are however, at war with elements of al Qaeda and the Taliban - on the basis that they are not only terrorists - but they are exporting that terrorism to the Western world, as we've seen on many occasions... The USS Cole, the embassy bombs, 9/11...

Hilder stated to Pope that “9/11 was an inside job” (a phrase with implicit assumptions). Pope responded:

*No, it's not... I worked for government for 21 years. I know what governments do. I know what governments don't do and you know I've looked at both sides of this. **I've looked at the conspiracy theories.** I've looked at the 9/11 Commission report...*

Pope is then asked how burning jet fuel could have destroyed the buildings (Hilder incorrectly describes the buildings as “collapsing” – when it is clear they turned to dust). Pope responds:

*What you do need is for the steel to **lose its structural integrity** and that happens at a much lower temperature... So, the physics and the engineering is “not in...” I've spoken to people who do controlled demolitions and they've looked at **some of the 9/11 conspiracy theories.***



Steel “losing half its structural strength due to a fire started by burning jet fuel”

Pope does not acknowledge any evidence regarding what actually happened to the WTC buildings – but that is no different to the majority of other UFO/ET speakers and researchers - quite a few of whom seem to be helping the cover up (as we discussed in chapter 24). [But while we're on the subject of Nick Pope and what he might really be up to, let's take a look at his website.](#)⁹⁶⁷

The screenshot shows a web browser window with the URL 'nickpope.net/paid-spokesperson.htm'. The page has a navigation menu with buttons for 'Home', 'Biography', 'Paid Spokesperson' (highlighted), 'Public Speaking', 'Conspiracy Theories', 'Science Fiction', 'Books', 'MoD UFO Files', 'Rendition Forest', 'Latest News', 'UFOs', and 'Contact'. The main heading is 'Paid Spokesperson'. The text describes Nick Pope's work as a consultant and promotional role in the film, TV, and video game industries, listing clients like 20th Century Fox, Sony Pictures, Microsoft, and 7-Eleven. It also lists his PR and advertising work with agencies like Ketchum, Bartle Bogle Hegarty, and Taylor Herring. A list of campaign contributions includes consultancy, research, feature writing, product endorsement, and more. A photo shows Nick Pope at a 7-Eleven store, holding a 'Super 8 Check in to Space' promotion. A caption below the photo reads: 'Nick Pope on the 7-Eleven "Super 8 Check in to Space" promotion. © AP Images'.

“Get the story or the slant you want! Just stump up some cash!”

Earlier in the book, I alluded to the idea that someone was using Mayan Symbolism in Crop Formations to make them think about the “2012 end times” etc. [It seems that Mr Pope may also have been employed in this probable psy-op.](#)⁹⁶⁸ See right.

It was later revealed that Pope was actually promoting a PlayStation Game and the statements in this article were part of that promotion.⁹⁶⁹ He stated:

The screenshot shows a MailOnline article. The header includes 'MailOnline' and 'Science'. The navigation bar has links for 'Home | News | U.S. | Sport | TV & Showbiz | Australia | Femal | Health | Science | Money'. The article title is 'Keep an eye on the skies for saucers during the Olympics Games, warns former MoD UFO expert'. The byline is 'By EDDIE WIDEN FOR MAILONLINE'. The publication date is 'PUBLISHED: 14:11, 7 June 2012 | UPDATED: 18:13, 7 June 2012'. The article text includes: 'UFO expert Nick Pope says massive summer events like the Olympics would be a prime time for an alien encounter', 'Ministry of Defence has planned for the worst outcomes - attack and invasion', and 'We should be prepared for even the most seemingly unfathomable!'. A sub-headline reads: 'One of the UK's top UFO experts has given his views on the likelihood of aliens suddenly appearing in our skies - and how the international community would respond.' The main text begins: 'Nick Pope, who has more than two decades under his belt at the Ministry of Defence, said mass summer events - like the Olympic Games in London - would be a prime time for crafts from otherworlds to present themselves to mankind.'

My comments concerning Alien Invasion etc, arose because I was commissioned to do some tie-in PR for the launch of the alien invasion themed Sony PlayStation game, "Resistance: Burning Skies", out exclusively on the PlayStation Vita. I came up with the idea of an alien invasion war plan. There are 2 versions out there, I can email you copies, a serious version and a more pop culture version that got picked up by the Daily Mail.

Mr Pope, then:

- Has had to “refute” the notion that directed energy weapons were used to create Crop Formations.
- Spouts the official story of 9/11, even though he is clearly an articulate and intelligent person.
- Will change his slant on a story depending on who’s paying him.

Yet Mr Pope continues to make regular conference and media appearances - as some kind of expert on the truth about these phenomena.

Dr Jacques Vallee and Directed Energy Weapons

We will take a short “detour” in this subsection, to discuss Dr Vallee, due to statements he made in 2004 about the Crop Formation phenomenon. Read on...

Dr Jacques Vallee seems to be one of those people who “thinks on a different level” – and [reading one biography](#)⁹⁷⁰ (below) [or another of him](#)⁹⁷¹ gives you a big clue to why that is:

Dr Vallee was born in France and received his B.S. in mathematics from the Sorbonne followed by his M.S. in astrophysics from Lille. He came to the United States in 1962 and received a Ph.D. in computer science from North-western University. He was a principal investigator on the large NSF project for computer networking, which developed the first conferencing system on the ARPANET many years before the Internet was formed. He has also served on the National



Advisory Committee of the University of Michigan College of Engineering. Dr Vallee has authored three books on high technology, including Computer Message Systems, Electronic Meetings and The Network Revolution. Along with his mentor Dr J. Allen Hynek, Dr Vallee carefully studied the problem of UFOs for many years and served as the real-life model for Francois Truffaut in Steven Spielberg's film Close Encounters of the Third Kind. His research has taken him to countries all over the world. Considered one of the leading experts in UFO phenomena, Dr Vallee has written several well-respected scientific books on the subject.

Also, of note is that Vallee first became interested in the UFO/ET issue in 1961 while working on the French Space Committee, where he witnessed the destruction of tracking tapes of unknown objects.⁹⁷² It was after this that he came to work in the USA. Noting that Vallee also worked at SRI, I can suggest that Vallee “knew quite a bit.” [Also, if you listen to his interviews](#),⁹⁷³ you may get the same sense that he “knows more than he can say.” He is clearly of great intelligence and for this reason and because of the expertise

and experience he has, it is quite likely he has done intelligence work for one or more governments.

Hence, I was particularly interested to read [an article which appeared sometime late in 2004, entitled “Crop Circles: “Signs” From Above or Human Artefacts?”](#) In this article, Jacques Vallee states⁹⁷⁴:

The early formations were simple circles, then circles with satellites. In later years more and more sophisticated and precisely-drawn geometric figures appeared. All the significant formations were observed in an area in close proximity to major research facilities of the British defence establishment, often in controlled airspace.

These studies point to the Crop Formations as the result of sophisticated electronic warfare experiments conducted by defence contractors. If you are trying to calibrate a beam, drawing a pattern on a wheat field can yield precision information within the diameter of one stalk over hundreds of feet, an ideal test situation.

Sooner or later the truth will be known, and it can be used to discredit the community of paranormal researchers who have rushed to decipher alien scripts in the formations, or have hypothesized a return of the Druids, earth lights or messages from Gaia without first testing the basic physics of the situation. It may also be that such hypotheses have been coldly planted among the New Age milieu as part of a psychological warfare experiment, and that the real nature of the Crop Formations can thus be hidden from serious attention for a very long time.

Jacques Vallee on the Rendlesham Case

Earlier in this book, I briefly covered the Rendlesham UFO landing case. Dr Vallee when asked about the case in [an interview on Coast to Coast on 12 Feb 2008](#),⁹⁷⁵ gave an interesting perspective:

I'm very puzzled by it... I am wondering whether it is a psychological warfare exercise... There are hints that there were people who knew that that light was going to be there... and it arrived over the North Sea. That is the kind of situation you would set up if you... wanted to expose a number of people – a calibrated cohort of subjects to a stimulus that would be unknown to them and then gauge their reaction in a military context. That is just too similar to other psychological warfare exercises to jump to the conclusion that it was a UFO.

He also [writes about this in his book “Revelations”](#)⁹⁷⁶ in “Part Two - The Hall Of Mirrors:”

Chapter Six describes the 1980 case of the landing at Rendlesham Forest near Bentwaters Air Force Base in England, an episode that is supported by American and British Air Force documents. The Bentwaters case points to the possibility that military groups engaged in psychological warfare have actually mastered the art of simulating close encounters and have designed exercises involving confrontations with nonlethal weapon platforms disguised as unidentified flying objects.

He elaborates on this, suggesting that advanced remotely-piloted vehicles (RPVs) might have been used in the Rendlesham operation:

Although such remotely-piloted vehicles would have been difficult to produce in the early Fifties, and therefore cannot explain the totality of the UFO phenomenon, they were already well-developed by the time of the Vietnam War... The devices in question can be equipped with mechanical, optical, and electronic devices that can be used in sequence or in combination to produce very spectacular UFO sightings.

The simplest such device is a model of a disk, two to four feet in diameter. We are not talking here about crude garbage-can covers equipped with hobby rockets, but exquisitely controlled systems carrying microprocessors and guided by radio. Miniature television cameras enable these gadgets to survey their surroundings and to transmit pictures. They can maneuver in and out of trees. The inventor of such a device, who developed it for a U.S. intelligence agency in the Sixties, has told me he could make it fly around a meeting room and out of a window. It produced no more sound than a whir.

Next in the list of mechanical devices are actual flying saucers of the type developed by Dr Moller near Sacramento, California. These vehicles are highly maneuverable and develop sufficient thrust to carry one pilot with his equipment. They are being manufactured to serve as reconnaissance platforms in hostile terrain. Their diameter is on the order of eight feet. Equipped with lights, they could be indistinguishable from actual saucers.

Here, I feel Vallee isn't really talking about advanced craft with antigravity propulsion systems, as was discussed in my "Finding the Secret Space Programme" book – he's talking about advanced, but more conventional technology. Perhaps Vallee himself is also adopting a "limited hangout" position. Elsewhere in his "Revelations" book, he suggests that John Lear and Bill Cooper were simply repeating disinformation about crashed saucers and aliens. Vallee fails to point out that Cooper accurately predicted certain aspects of 9/11. Although, for example, Vallee mentions the Aztec crash, he does not mention Scott Ramsey's detailed research, which we covered in chapter 5. Rather, he focuses on the story about the recovery of bodies and attaches it to Richard Doty. Also, Vallee makes no mention of the "Starchild" skull, covered in chapter 21, for example (most UFO/ET books make similar omissions). Vallee seems reluctant to discuss any type of physical evidence indicating the existence of alien beings.

Similarly, to my knowledge, Vallee has never commented about 9/11 – in the Coast to Coast interview in 2008, he evaded the question about 9/11. To me, particularly in view of the sorts of statements I listed above, Vallee is easily smart enough to see what really happened on 9/11. Vallee talks about directed energy weapons being used to create formations but does not relate this to 9/11 – even though we can look at a timeline of events which shows, for example, an apparent rapid increase in Crop Formation numbers in the 1990s and an apparent decrease in the 2000s – after the destruction of the WTC.

33. Crop Circle Conclusions

The Crop Circle Phenomenon is complex – in compiling these chapters, I found enormous quantities of information to try and digest. Like the UFO phenomenon, Crop Circles have no single cause or explanation – to suggest this ignores the abundance of evidence for each of the sources.

Light phenomena/Balls of Light are commonly reported near and in Crop Formations – these have also been videotaped. Reports of physical alien beings and flying saucers/structured craft being associated with the appearance of formations seem to be far less common.

Explanations

Crop Formations are *not* created solely by board-stompers and, indeed, people who have reported on their own planking activities have also witnessed and experienced unusual phenomena such as Balls of Light.

Although studying plant abnormalities does not prove that a formation has been made by non-mechanical means, when studying many events, a pattern emerges -which seems to indicate that microwaves – or a similar type of energy – are involved in the creation of formations.

It is clear from the evidence that some Crop Formations have been created by some intelligence agencies (or other groups working on their behalf) using mechanical methods, to generate confusion and conflict within the research community. I would also go further – agreeing with Dr Jacques Vallee – that some Crop Formations have been created by non-mechanical methods to inject certain false information into the New Age Movement. The whole scene has been deliberately “muddled up” and any “genuine” messages that *may* be in some Crop Circles have been successfully confused and obscured.

It very much seems to me that [when official interest was expressed in 1990⁹⁷⁷](#), the perception management operation regarding the formations was “kicked into high gear” and the following year, official interest was more or less shutdown, using the [Channel 4 “Equinox” documentary⁹⁷⁸](#) and the [“Doug and Dave” story⁹⁷⁹](#) that we covered in earlier chapters. Perhaps it was the case that government ministers and “lower levels” of the military got wind that something very odd was happening in their midst and so they started investigating. The intelligence services (MI5 and CIA for example) then began to “manage this interest” as plans for the destruction of the WTC were probably already underway. (Perhaps the destruction of the Alfred P Murrah building in 1995 was an earlier demonstration or test of the technology, as I discussed in chapter 28 of [“9/11 Holding the Truth”⁹³](#))

However, I would not rule out that unknown “Forces of Light” are involved in creating some formations. Even though it can be argued that using Crop Formation patterns does seem like a strange way to communicate anything, I am willing to accept that some agency might be working in a more abstract way, as I will discuss next.

Consciousness Aspects

Several researchers have pointed out that Consciousness seems to be an important aspect of the Phenomenon. The basic idea is that an outside intelligence is using Crop Circles with messages and symbolism to make us realise that “we are not alone” and other forms of intelligence can express themselves in ways we do not fully understand. This sort of idea/theme is explored in an interesting video you can watch online called “[Crop Circles: Quest for Truth](#).”⁹⁸⁰

In that documentary, for example, Lucy Pringle noted how the Crop Circle phenomenon was something that “got many people talking” from many different disciplines. They were all trying to understand what was going on. Another theme that emerges is that higher dimensional forces, energies and even beings were involved – a theme which overlaps with the UFO/ET phenomenon.

Some researchers argued that the [Human Butterfly Crop Formation, which appeared in Denmark in 2009 \(and was the largest formation ever found\)](#)⁹⁸¹ was meant to be a blatant symbol of the transformation of humans and/or their consciousness. Other researchers [might argue that it was a symbol related to the monarch mind control programme](#).⁹⁸²

Gaia, The Environment and Crop Formations

As we have touched on briefly, others suggest that the phenomenon is at least in part a manifestation of the desires of “Gaia” (mother earth) to communicate that we should care for the planet. Whilst this might even be true, those people should also realise that the evidence and truth has now been revealed that we are not truly responsible for the environmental problems. These problems have been created or induced by those in the shadows – the ones that are covering up the truth about Crop Circles.

Those in the shadows committed the covert criminal acts which destroyed the WTC on 9/11, not us! We are not to blame for the state of the environment - THEY are responsible for setting up and maintaining the circumstances of our existence. This is demonstrated in my “[Climate Change and Global Warming Exposed](#)”³⁴⁴ book. Hence, it is disappointing to find so many folks like Colin Andrews talking about [climate change on their websites and remaining ignorant of the truth](#)⁹⁸³ – which is what they claim to be interested in finding in the first place.

So why do the formations still appear? How will they evolve in future? Are they, ultimately, just “part and parcel” of the “way the universe works,” as different forces – physical and spiritual – come into conflict?

Part III

Some Final Thoughts

34. Discovery, not Disclosure...

“Here are the Main Points Again...”

I will now state my own conclusions about topics directly and indirectly related to the disclosure/ET issue – some of which I have written about in this book and some in my other books.

- Space Craft from other worlds containing non-human beings have been visiting the earth for 10s if not millions of years.
- Some ET's may have lived on earth or interacted with life on the planet in some way for millions or billions of years.
- For other ET's, today might be the first day they've ever heard of the earth or visited or studied it!
- Control of all types of energy (Electrical, Magnetic, Conscious and Life) has been developed to a very high level by those running the planet – and weaponised. Some of this technology has almost certainly been used to create *some* Crop Formations.
- Human Consciousness is not restricted to the physical body alone.
- Energy and Consciousness are inter-related.
- A secret space programme exists.
- The Apollo Missions were a hoax.
- The Darwinian theory of evolution is incorrect and other factors – including non-terrestrial intervention, have almost certainly contributed to the development of homo sapiens.
- From the research of Dr Judy Wood, we know that secret, weaponised “free” energy and weather control technology is real and was employed during the destruction of the WTC on 9/11.

Disclosure?

Attempts at UFO/ET Disclosure have been ongoing since at least 1950. This book barely scratches the surface of what is an extremely complex and detailed body of evidence relating to a profound subject. Despite this, certain truths are easily established. Official bodies and groups (governments, academia, religions), even if they acknowledge – tacitly or otherwise - certain truths, don't change the way they operate. Experience has shown they have not taken any kind of action over anything related to any of what is written in this book. Therefore, honest/full Disclosure is unlikely to come from any establishment, group or party with vested interests – be they corporate, commercial, political or even spiritual.

Disclosure is not happening – but *personal discovery* - for those who are curious - *is happening*, due to the wealth of information that is available, if you know where to look.

Eisenhower warned us about the Military Industrial Complex. He, like most World Leaders, probably was aware of the network of secrecy which is used to run the world. All countries have a secrecy apparatus – now made more comprehensive since the events of 9/11. It is so insidious and so tangled that even whistle-blowers who have come forward may not be able to give us accurate information.

Enormous crimes – the destruction of the WTC being one example - have been and are being committed in the name of secrecy related to the reality of world-changing technologies. The same is true in relation to what is known about the technology associated with UFO/ET phenomena – i.e. that technology has been kept secret and used to commit atrocities of various kinds.

Turn the Black World White

In reading through many cases of relating to official knowledge of UFOs, aliens and the like, the names of several places and institutions repeatedly reoccur – Los Alamos National Laboratories (LANL), SRI, Area 51 (the Nevada Test Site) and Nellis AFB, Wright Patterson Air Force Base, Sandia Labs, SAIC, Lockheed Skunkworks, ONI, CIA, NSA, NRO – how long should I make the list..? It is these organisations, along with the “blacker” parts of the world’s military forces – and secret societies such as Freemasons, Opus Dei and their like, along with “special interest” groups like Zionists and the Bilderberg group which, to “steal” a word from Dr Steven Greer form a “kleptocracy.” There are probably smaller counterparts to some of these groups and organisations in the Russian Federation and the rest of Asia and China. They steal knowledge and resources, which should be shared with everyone – rather than revealing things and educating us all. They don’t advertise what they are doing because they know it is wrong. Also, many of the people in these groups probably don’t even know the truth of what is in this book – if they did, they would have knowledge which transcends much of what motivates their wish for a particular outcome for some large business or military interest, or the state of Israel - or in their own selfish dealings.

It is now long past the time where these institutions and similar ones - should “turn white.” I am not sure how this could be made to happen, but it seems clear that somewhere in these places, there are people who know a lot more than the rest of us and they are, essentially, committing crimes against humanity every single hour of every single day. Will this ever stop? Again, if you, dear reader, are involved in black world programmes – i.e. you’re doing something *that secret*, it probably means it’s not in the best interests of common people. Think about it.

I now make an appeal. It is that “we turn the black world white.” It is now time for anyone working on secret programmes which are responsible for weapons, biowarfare or free energy devices to either leave those programmes or think very carefully about “whose side they are on.” It’s time for some soul-searching. It’s time to make the world better – openly, not by doing things in secret – because of a distorted set of moral values, based on excuses, lies and deception. The enormous mess that the world is in can – and should - be “cleaned up.” It should be cleaned up by those that created the mess – not the rest of us – the ones that have been put in that mess. So, any of you people reading this who participate in secret billion and trillion-dollar secret USAPs - projects and programmes, should consider redeeming yourselves. Fix the mess! Do it!

Telling the Truth in Research and Everyday Life

In the last chapter of my book “[9/11 Holding the Truth](#)”⁹⁸⁴,” I stated some general conclusions and “guidelines” for “improving our lot.” I summarise my “ideas” below.

If you want to know the truth, you must also speak the truth. If you find you have made a mistake in your conclusions, admit this mistake and accept corrections gracefully. Having the humility to accept errors you have made means that the power of lies and the power of liars is lessened.

Those people who are genuinely interested in knowing the truth are all-too-often perception-managed by researchers and other people who claim to be interested in knowing the truth but are controlled or influenced by the “secret keepers” to keep important things covered up. Whilst people like Steven Greer and Stephen Bassett have played an important role in revealing *certain* truths (and we might even thank them for doing so), they have also misled people or even conned them. This is not acceptable behaviour.

We then have a situation in the UFO/ET research community (and similar research communities, it seems) where those who *aren't* actually co-opted or paid to act within certain boundaries, are heavily influenced by those that *are* co-opted. Similarly, there are armies of disingenuous sceptics and “trolls” on the internet who make so much “noise” that people cannot hear the truth and don’t have time to “sort through” everything.

As I have alluded to, an interest in, and discussion of, the truth and knowledge about the events of 9/11 - and their significance - can be used as a tool and “litmus test” of the openness and honesty of other researchers. This test will, more often than not, reveal if they (a) have another agenda or (b) are actually open to learning new things.

To Sum Up...

Official formal disclosure will not happen, due to the decades of atrocities committed in the name of “National Security” by so many corrupted agencies. The track record is clear: denial, deception and cover up are the default

positions and activities. The media and alternative media are complicit in much of this – if they weren't complicit, it would not be necessary for the many researchers mentioned in this book (and myself) to devote their time and energy to compile documents, information and evidence in the way they have. Avoiding the bulk of mainstream media output will lessen the effects the secret keepers, who control these organisations, can have on your thinking.

As I already said, one basis for change is simple enough – tell the truth – in all you do and all you say. Enlightenment comes from knowing the truth. To know the truth fully, you should tell the truth. Unless and until our culture revolves around the act of telling the truth, disclosure will not happen and, by default, deception will continue. Corporate, military, academic, media and government structures will all need to be “dissolved and reformed” if the truth is to become universally known. Each individual must take responsibility for their own knowledge, learning and understanding – but this will be impossible without them having access to truthful information and truthful leaders – who are interested in their own spiritual development and that of those around them, rather than gaining power over others or devoting too much time to purely hedonistic pursuits.

Thank You!

In closing then, I would like to thank you for working your way through to the end, and for considering what I have presented to you. I hope you have found it enlightening and useful and that the information herein helps you to detect deception more easily and mitigate the effects it has on your thinking and the decisions you make.

References

On finishing the book, I had a list of over 900 references. This list would have filled about 20 additional pages. You can access the list of references using this link:

<http://www.checktheevidence.com/apuacc.html>

35. References

- ¹ <http://hubble.stsci.edu/gallery/album/galaxy/pr2002011e/titles/true/hires/true/>
- ² <https://dreamsofspace.blogspot.com/2010/01/flying-saucers-and-outer-space-1969.html>
- ³ <https://www.amazon.co.uk/Alien-Investigator-Britains-Leading-Detective/dp/0747222851>
- ⁴ <https://web.archive.org/web/20091030020431/https://ellisctaylor.com/tonydodd.html>
- ⁵ <http://colinandrews.net/TonyDoddPassing.html>
- ⁶ <http://www.ufo-mystery.co.uk/ukcases/80sgodfrey.php>
- ⁷ <http://www.disclosureproject.org/>
- ⁸ http://www.bbc.co.uk/pressoffice/pressreleases/stories/2003/03_march/07/ufo_aliens.shtml
- ⁹ <https://www.amazon.co.uk/You-Cant-Tell-People-Definitive/dp/033039021X>
- ¹⁰ <https://www.youtube.com/watch?v=4DrcG7VGgQU>
- ¹¹ <https://web.archive.org/web/20031008120255/http://www.disclosureproject.org:80/dprepscontacts.htm>
- ¹² <http://news.bbc.co.uk/1/hi/world/americas/1322432.stm>
- ¹³ <https://www.ufoinsight.com/japanese-airlines-flight-1628-ufo-encounter/>
- ¹⁴ <http://disclosureproject.org/access/docs/pdf/DisclosureProjectBriefingDocumentNoDocs.pdf>
- ¹⁵ <https://www.youtube.com/watch?v=OqxPqFuaEYw>
- ¹⁶ http://www.checktheevidence.com/Disclosure/Newspaper_Articles_etc/Rendlesham_dailymail.jpg
- ¹⁷ http://www.bbc.co.uk/pressoffice/pressreleases/stories/2003/03_march/07/ufo_aliens.shtml
- ¹⁸ <https://youtu.be/cYPCKIL7oVw?t=1h34s>
- ¹⁹ http://www.checktheevidence.com/Disclosure/Web_Pages/www.geocities.com/Area51/Cavern/1001/memo.jpg
- ²⁰ https://www.imdb.com/title/tt4549938/?ref_=ttep_ep1
- ²¹ http://www.presidentialufo.com/old_site/bush_ufo_story.htm
- ²² <https://www.youtube.com/watch?v=27rxxUot-y4>
- ²³ <https://www.youtube.com/watch?v=f9ZoKfYCNlM>
- ²⁴ http://www.cufos.org/UFOI_and_Selected_Documents/UFOI/131_FEBRUARY_1977.pdf
- ²⁵ http://www.presidentialufo.com/old_site/reagan_ufo_story.htm
- ²⁶ <http://www.aintitcool.com/node/49921>
- ²⁷ <http://static3.aintitcool.com/assets2011/SSc7.mp3>
- ²⁸ http://www.presidentialufo.com/old_site/clinton_roswell.htm
- ²⁹ http://www.presidentialufo.com/old_site/part1.htm
- ³⁰ <https://www.youtube.com/watch?v=tF9aZF3WfG0>
- ³¹ <https://www.nationalarchives.gov.uk/ufo/existing-files.htm>
- ³² <https://www.telegraph.co.uk/news/newstoppers/howaboutthat/ufo/8221227/New-Zealand-releases-UFO-files.html>
- ³³ <https://siriusdisclosure.com/evidence/countries-releasing-ufo-information/>
- ³⁴ <http://ufoevidence.org/topics/governmentstudies.htm>
- ³⁵ <http://www.project1947.com/fig/projsauc.htm>
- ³⁶ <http://ufoevidence.org/documents/doc1981.htm>
- ³⁷ <https://www.theguardian.com/news/2004/may/20/guardianobituaries1>
- ³⁸ <https://archive.org/details/TheCometaReport/page/n1>
- ³⁹ <https://www.bbc.co.uk/search?q=cometa&filter=news>
- ⁴⁰ http://www.checktheevidence.com/Disclosure/Web_Pages/COMETA.htm

- 41 <http://www.disclosureproject.org/lkean-bostonglobe-may-21-2000.shtml>
- 42 <https://www.checktheevidence.com/wordpress/2018/05/31/book-finding-the-secret-space-programme/>
- 43 <http://www.darkstar1.co.uk/alienrock.html>
- 44 <http://www.checktheevidence.com/audio2/index.php?dir=ET%20and%20UFO/>
- 45 <http://www.robbiegraham.uk/books/silver-screen-saucers/>
- 46 <http://sssaucers.com/category/hollywood-ufos/>
- 47 <http://www.azlyrics.com/lyrics/davidbowie/lovingthealien.html>
- 48 <https://www.youtube.com/watch?v=ns2hmyP0mGY>
- 49 <http://www.youtube.com/watch?v=uhSYbRiYwTY>
- 50 <https://www.youtube.com/watch?v=ipRkQFWEvSA>
- 51 <http://www.imdb.com/name/nm0000309/bio>
- 52 <http://www.youtube.com/watch?v=muMeWMKPEWQ>
- 53 <http://www.youtube.com/watch?v=-IqqusnNQ&feature=av2e>
- 54 <http://lyricsplayground.com/alpha/songs/o/ohyouprettythings.shtml>
- 55 <http://www.youtube.com/watch?v=pBQ-S6njQQw>
- 56 <http://web.archive.org/web/20050302174659/www.xdream.freemove.co.uk/David+Bowie/Timeline.htm>
- 57 <http://www.imdb.com/title/tt0074851/>
- 58 <https://www.youtube.com/watch?v=kszLwBaC4Sw>
- 59 <https://www.youtube.com/watch?v=WeiufBduVE8>
- 60 <https://www.azlyrics.com/lyrics/hotchocolate/nodoubtaboutit.html>
- 61 http://www.watfordobserver.co.uk/leisure/interviews/8918607.Close_encounter_with_a_hit_song/
- 62 <http://www.thinkaboutitdocs.com/john-lennon-sighting/>
- 63 <https://ledgernote.com/blog/interesting/john-lennon-sketches-ufo/>
- 64 <http://www.checktheevidence.com/Disclosure/Audio/johnlennon.mp3>
- 65 <http://www.ufomind.com/misc/1997/sep/d23-001.shtml>
- 66 <http://www.ignaciodarnaude.com/ufologia/FSR 1991 V 36 N 2.pdf>
- 67 <http://www.moodybluestoday.com/graeme-edge/>
- 68 <http://www.educatinghumanity.com/2016/03/moody-blues--ufo-sighting.html>
- 69 <http://www.classicrockhereandnow.com/2014/02/michael-pinder-exclusive-moody-blues.html>
- 70 <http://earthmysterynews.com/2016/08/31/the-moody-blues-song-based-on-a-ufo-sighting-has-strong-indications-of-an-abduction/>
- 71 <https://www.youtube.com/watch?v=IFBDgYbSWg8>
- 72 <http://www.moodybluestoday.com/john-lodge/>
- 73 <https://www.youtube.com/watch?v=t5Sd5c4o9UM>
- 74 https://www.youtube.com/watch?v=F_qj31euiY
- 75 <https://www.amazon.co.uk/Musical-Truth-Mark-Devlin/dp/1910757489>
- 76 <https://www.azlyrics.com/lyrics/katyperry/et.html>
- 77 <http://www.checktheevidence.com/pdf/SFATHGA Omnibus 2018.pdf>
- 78 <https://www.dailymotion.com/video/x2fgg8w>
- 79 <http://www.imdb.com/title/tt0043456/plotsummary>
- 80 <https://www.amazon.co.uk/Project-Disclosure-Revealing-Government-Conspiracies/dp/1477781552>
- 81 <http://thenightsky.org/hynek.html>
- 82 <http://screenprism.com/insights/article/how-did-astronomer-dr.-j.-allen-hynek-contribute-to-close-encounters-of-the>

- 83 <https://www.imdb.com/title/tt0407304/>
- 84 <https://www.theguardian.com/film/2007/aug/01/stevenspielberg.martinamis>
- 85 <https://www.youtube.com/watch?v=u9ZZekWMiUQ>
- 86 <http://www.educatinghumanity.com/2013/07/ben-rich-esp-will-take-et-home.html>
- 87 <https://youtu.be/nS02sosYBng?t=1383>
- 88 <https://siriusdisclosure.com/evidence/project-aquarius-documents/>
- 89 https://www.imdb.com/title/tt0116629/plotsummary?ref_=tt_stry_pl
- 90 <https://www.youtube.com/watch?v=RR4rZ2bD8CE>
- 91 https://www.youtube.com/watch?v=_UNMkUlbq0
- 92 <http://tomatobubble.com/id884.html>
- 93 <https://www.checktheevidence.com/wordpress/2017/11/20/9-11-holding-the-truth/>
- 94 <https://www.fantasticfiction.com/s/carl-sagan/>
- 95 https://www.imdb.com/title/tt0118884/plotsummary?ref_=tt_stry_pl
- 96 <https://www.checktheevidence.com/wordpress/2017/12/21/book-secrets-in-the-solar-system-gatekeepers-on-earth/>
- 97 <https://www.yahoo.com/entertainment/john-carpenter-looks-back-on-they-live-its-174619686.html>
- 98 <http://exopoliticsjournal.com/vol-3/vol-3-2-Gould.htm>
- 99 <http://www.oscarmagocsi.com/index.php/blog/27-interview-with-ufo-contactee-sixto-paz-wells>
- 100 <https://www.phantomsandmonsters.com/2012/02/fatima-ufo-hypothesis.html>
- 101 <http://www.educatinghumanity.com/2015/04/aliens-asking-do-you-wish-we-show-up.html>
- 102 <http://www.checktheevidence.com/Disclosure/Web Pages/ufo - UFOS at close sight the newspapers%2C.htm>
- 103 <http://www.checktheevidence.com/Disclosure/Web Pages/Witness To Washington Flap July%2C 1952.htm>
- 104 http://the-wanderling.com/la_ufo.html
- 105 https://www.youtube.com/watch?v=5jy0_2EOfS4
- 106 <http://astronomyufo.com/UF0/mexico.htm>
- 107 <https://youtu.be/cYPCKIL7oVw?t=7m33s>
- 108 <http://ufocasebook.com/phenixlights.html>
- 109 <https://www.ufoinsight.com/stephenville-incident-whats-special-part-texas/>
- 110 <https://www.youtube.com/watch?v=P2XPbjV1kHY>
- 111 https://www.goodreads.com/book/show/209259.The_Space_Gods_Revealed
- 112 <http://www.checktheevidence.com/wordpress/2007/11/13/the-usual-suspects-anatomy-of-a-disinformation-campaign-in-ufology/>
- 113 <http://www.travis-walton.com/book.html>
- 114 http://news.bbc.co.uk/onthisday/hi/dates/stories/april/25/newsid_4464000/4464109.stm
- 115 <http://www.markhorrell.com/blog/2013/did-chinese-climbers-reach-the-summit-of-everest-in-1960/>
- 116 <http://www.checktheevidence.com/Disclosure/Audio/DrRobertJacobs.mp3>
- 117 <https://www.smithsonianmag.com/history/infamous-war-worlds-radio-broadcast-was-magnificent-fluke-180955180/>
- 118 <http://www.checktheevidence.com/pdf/Science Fiction and the Hidden Global Agenda - 2016 Edition - Vol 1.pdf>
- 119 <http://marcsifer.com/nikola-tesla.html>
- 120 <http://www.checktheevidence.com/Disclosure/PDF Documents/gravitsapa.pdf>
- 121 <https://siriusdisclosure.com/wp-content/uploads/2012/12/DP-Witness-Overview-Long.pdf>
- 122 <http://astroguyz.com/2011/06/02/declassified-the-true-tale-of-project-orion/>

- 123 <http://www.islandone.org/Propulsion/ProjectOrion.html>
- 124 <http://www.checktheevidence.com/wordpress/2017/12/21/book-secrets-in-the-solar-system-gatekeepers-on-earth/>
- 125 <https://exoplanets.nasa.gov/>
- 126 <https://www.bbc.co.uk/news/science-environment-44952710>
- 127 <http://www.checktheevidence.com/Disclosure/Web Pages/Are We All Aliens The New Case for Panspermia.htm>
- 128 <http://www.checktheevidence.com/pdf/Directed Panspermia F. H. C. CRICK AND L. E. Orgel.pdf>
- 129 <https://www.britannica.com/science/Drake-equation>
- 130 <https://www.famousscientists.org/frank-drake/>
- 131 <http://sethshostak.com/>
- 132 <https://www.space.com/1739-public-split-alien-invaders-spooky-specters.html>
- 133 <http://www.checktheevidence.com/Misc/Seth Shostak on UFOs 11 Nov 2005.htm>
- 134 <http://www.checktheevidence.com/audio2/index.phpET and UFO/Seth Shostak and Stanton Friedman - Coast to Coast - Jul 21 2004 - mp3.mp3>
- 135 https://www.amazon.co.uk/Paul-Davies/e/B000AP7VUM/ref=dp_byline_cont_book_1
- 136 <https://www.amazon.co.uk/Aliens-Science-Asks-There-Anyone/dp/1781256810>
- 137 https://www.amazon.co.uk/Michio-Kaku/e/B000ARDFYQ/ref=dp_byline_cont_book_1
- 138 <http://www.cufos.org/Hynekbio.html>
- 139 <http://www.ufoevidence.org/documents/doc758.htm>
- 140 <http://www.ufoevidence.org/Cases/CaseView.asp?section=UFOCrash>
- 141 <http://majiceyesonly.com/>
- 142 <https://www.amazon.co.uk/Witness-Roswell-Revised-Expanded-Governments/dp/1601630662>
- 143 <https://www.amazon.co.uk/Crash-Corona-Military-Retrieval-Cover-Up/dp/1931044899>
- 144 <http://roswellproof.homestead.com/>
- 145 <https://www.imdb.com/title/tt0111021/>
- 146 <http://www.crystalinks.com/roswell.html>
- 147 <http://roswellproof.homestead.com/Haut.html>
- 148 <https://www.ufocasebook.com/pdf/crainclarkson.pdf>
- 149 <http://jamesclarksonufo.com/in-the-media/radio>
- 150 <http://www.youtube.com/watch?v=gPFBg1NNUBU>
- 151 http://roswellproof.homestead.com/debris2_memory_foil.html
- 152 <https://youtu.be/4hX-HE3HaZs?t=1m50s>
- 153 <https://www.ufoexplorations.com/about-bio>
- 154 <https://www.battelle.org/>
- 155 <https://www.heraldtribune.com/article/LK/20090521/News/605211653/SH/>
- 156 <http://roswellproof.homestead.com/files/ROSDEBRI.DOC>
- 157 <https://web.archive.org/web/20080312072432/http://ufophysical.com/>
- 158 <http://www.project1947.com/47cats/phillips.htm>
- 159 https://www.youtube.com/watch?v=pK_HhJUyHsY
- 160 <https://www.theblackvault.com/casefiles/analysis-soil-samples-related-delphos-kansas-november-2-1971/>
- 161 <https://www.youtube.com/watch?v=VDVU-1NpaNA>
- 162 <http://www.latest-ufo-sightings.net/2014/08/aurora-texas-1897-ufo-incident.html>
- 163 <http://bauxite.world-aluminium.org/mining/process.html>
- 164 [http://avalonlibrary.net/Collection_of_193_EBooks/Frank Scully - Behind the Flying Saucers \(1950\).pdf](http://avalonlibrary.net/Collection_of_193_EBooks/Frank Scully - Behind the Flying Saucers (1950).pdf)

- 165 <http://www.theaztecincident.com/>
- 166 <https://ufocasebook.com/Zamora.html>
- 167 <http://www.stangordon.info/wp/buy-stuff-here/kecksburg-the-untold-story/>
- 168 <http://ufoevidence.org/documents/doc1311.htm>
- 169 <https://www.theufochronicles.com/2006/04/kecksburg-ufo-to-land-in-new-home.html>
- 170 <https://www.amazon.com/History-Ufo-Crashes-Kevin-Randle/dp/0380776669>
- 171 <https://www.youtube.com/watch?v=mPbDa5D7IUE>
- 172 <http://shagharbourincident.com/the-incident/>
- 173 <https://www.amazon.com/Dark-Object-Worlds-Government-Documented-Crash/dp/0440236479>
- 174 <https://www.youtube.com/channel/UCDsUlpfGsXvjIXOIKSXaijQ>
- 175 <https://youtu.be/xtY9QVLHC5E>
- 176 <https://www.dailypost.co.uk/news/north-wales-news/berwyn-mountains-ufo-crash-40-6554715>
- 177 <https://www.youtube.com/watch?v=IGxVpQC42oI>
- 178 https://www.richplanet.net/richp_search.php?ref=170&part=1
- 179 http://www.therendleshamforestincident.com/The_Full_Report.html
- 180 <http://www.therendleshamforestincident.com/uploads/suffolk-police-file.pdf>
- 181 http://www.therendleshamforestincident.com/The_Book.html
- 182 <https://www.youtube.com/user/secretnasaman>
- 183 <https://www-istp.gsfc.nasa.gov/Education/wtether.html>
- 184 <https://www.youtube.com/watch?v=Z4UxPF73cVk>
- 185 <https://www.youtube.com/watch?v=IBIrANSMihg>
- 186 <https://www.youtube.com/watch?v=cYPCKIL7oVw>
- 187 <http://thephoenixlights.net/Bio.htm>
- 188 <https://www.ufosightingsdaily.com/p/police-sightings.html>
- 189 <https://www.youtube.com/watch?v=sj57rm-D6Ok>
- 190 <https://youtu.be/sj57rm-D6Ok?t=1860>
- 191 <https://rense.com/general31/woods1A.htm>
- 192 <https://www.unexplained-mysteries.com/forum/topic/38627-what-happened-to-anthony-woods/>
- 193 <http://www.fsr.org.uk/GBirdsall.htm>
- 194 <https://www.youtube.com/watch?v=zKAX24GVDmU>
- 195 <https://www.youtube.com/watch?v=sfAmuNg4-2s>
- 196 <https://www.facebook.com/bob.jacobs1>
- 197 <http://www.ufohastings.com/>
- 198 <http://www.ufosandnukes.com/>
- 199 <https://www.youtube.com/watch?v=3jUU4Z8QdHI>
- 200 <https://www.youtube.com/watch?v=KkZWHpP17Rc>
- 201 <https://www.youtube.com/watch?v=Rg-pp2BuKKk>
- 202 <https://lydia.bradley.edu/pubs/BUfaculty.html>
- 203 <https://www.youtube.com/watch?v=x4wL4lbwwNU>
- 204 <https://duckduckgo.com/?q=big+sur+california>
- 205 <https://youtu.be/cYPCKIL7oVw?t=2036>
- 206 <https://www.ufohastings.com/articles/deep-denial-or-disinformation>
- 207 <https://www.youtube.com/watch?v=O3wXSHFjpFc>
- 208 <https://youtu.be/uollt5yHfmo>

-
- 209 <https://www.youtube.com/watch?v=AVfycf3ZcQA>
- 210 <http://www.v-j-enterprises.com/astro5.html>
- 211 https://www.youtube.com/watch?v=wsEd_b1C8DY
- 212 <http://leespeigel.com/images/1978-UN-4-letter-astronaut2B.png>
- 213 <http://edition.cnn.com/2004/TECH/space/10/04/gordon.cooper/index.html>
- 214 <http://leespeigel.com/index.php?ptp=un>
- 215 <https://disneyandmore.blogspot.com/2009/07/gordon-cooper-when-legendary-astronaut.html>
- 216 https://www.youtube.com/watch?v=MIGsLA_sdmg
- 217 <https://www.youtube.com/watch?v=q6OKaMfPh4I>
- 218 <https://www.youtube.com/watch?v=d3CxapWyA8g>
- 219 <https://youtu.be/q6OKaMfPh4I?t=4m32s>
- 220 <http://www.noufors.com/Documents/evidence.pdf>
- 221 http://www.checktheevidence.com/audio/Buzz_Aldrin_and_UFOs.mp3
- 222 http://www.bahaistudies.net/asma/Eisenhower_and_the_Visitors.pdf
- 223 http://www.presidentialufo.com/old_site/
- 224 <http://www.rexresearch.com/smith/newsci~1.htm>
- 225 <http://www.gutenberg.org/ebooks/5883>
- 226 <http://www.checktheevidence.com/wordpress/2018/05/31/book-finding-the-secret-space-programme/>
- 227 http://www.presidentialufo.com/old_site/affa_cia.htm
- 228 http://www.checktheevidence.com/Disclosure/Audio/Wilbert_Smith_Vancouver_Talk_1958.mp3
- 229 <http://www.presidentialufo.com/wilbert-smith-articles/127-binding-forces>
- 230 <http://www.drjudywood.com/>
- 231 <http://www.wheredidthetowersgo.com/>
- 232 http://www.presidentialufo.com/old_site/crashed_saucer.htm
- 233 http://noufors.com/Dr_Robert_Sarbacher.htm
- 234 <https://www.foexplorations.com/of-roswell-and-rockets-v2-film>
- 235 http://presidentialufo.com/old_site/smith_sarbacher.htm
- 236 http://www.presidentialufo.com/old_site/new_page_8.htm
- 237 <http://www.youtube.com/watch?v=irrhscIn7qo>
- 238 http://www.presidentialufo.com/old_site/not_alone.htm
- 239 http://www.presidentialufo.com/old_site/wilbert_smith_articles.htm
- 240 <https://www.youtube.com/watch?v=OMYsFFtyKz4>
- 241 <http://www.checktheevidence.com/audio/?dir=WBSmith>
- 242 <https://web2.ph.utexas.edu/~coker2/index.files/sbrothers.shtml>
- 243 <https://web2.ph.utexas.edu/~coker2/coker.html>
- 244 <http://www.adamskifoundation.com/html/AboutGA.htm>
- 245 http://www.campbellgold.com/archive_esoteric/flying_saucers_have_landed_adamski_1955.pdf
- 246 <http://www.adamskifoundation.com/html/GAFPhoto.htm>
- 247 http://www.adamskifoundation.com/Rene_Erik_Olsen_-_Denmark/Rene-Denmark.html
- 248 <https://www.youtube.com/user/quantumcosmology09/videos>
- 249 <https://www.scribd.com/document/124812570/The-Journal-of-Borderland-Research-1965-06>
- 250 http://futureofmankind.co.uk/Billy_Meier/Eduard_Albert_Meier
- 251 <https://www.youtube.com/watch?v=Dxkn4zbcQwM>
- 252 <https://www.youtube.com/watch?v=nD8OWy6TIRQ>
-

- 253 <http://theyfly.com/about-michael-horn>
- 254 <http://futureofmankind.co.uk/>
- 255 http://www.futureofmankind.co.uk/Billy_Meier/Analysis_of_IIG's_Meier_Case_explanations
- 256 <https://ahigherstrangeness.wordpress.com/category/ufosflying-saucers/contacteesabductees/howard-menger/>
- 257 <https://www.youtube.com/watch?v=zkrm3oZV8Jo>
- 258 <https://science.howstuffworks.com/space/aliens-ufos/howard-menger.htm>
- 259 <https://www.scribd.com/document/100754767/From-Outer-Space-by-Howard-Menger>
- 260 https://www.amazon.co.uk/s/ref=nb_sb_noss?url=search-alias%3Daps&field-keywords=sixto+paz+wells
- 261 <http://www.sixtopazwells.com/>
- 262 <https://www.britannica.com/event/Project-Ozma>
- 263 https://www.windows2universe.org/jupiter/moons/ganymede_atmosphere.html
- 264 <https://images.nasa.gov/details-PIA01090.html>
- 265 <https://www.youtube.com/watch?v=TgGSVmrUT4>
- 266 <https://mysolaralerts.blogspot.com/2012/03/x11-solar-flare-1de-march-5-2012.html>
- 267 <https://www.space.com/26669-huge-solar-storm-2012-destruction.html>
- 268 <https://www.nbcnews.com/news/weather/hurricane-patricia-strongest-storm-ever-measured-hit-mexico-n449731>
- 269 https://www.nhc.noaa.gov/data/tcr/EP202015_Patricia.pdf
- 270 <http://starburstfound.org/galactic-cosmic-ray-volleys-a-coming-global-disaster/>
- 271 <https://www.amazon.com/Invitation-Sixto-Pas/dp/1887472290/>
- 272 https://www.amazon.com/gp/customer-reviews/R3QI5SH7M4QFHS/ref=cm_cr_arp_d_rvw_ttl?ie=UTF8&ASIN=1887472290
- 273 https://www.youtube.com/watch?v=0SW_I-kSGck
- 274 <https://www.aetherius.org/overview/>
- 275 https://www.youtube.com/watch?v=E_R2lIjo5il
- 276 <http://www.eceti.org/books.html>
- 277 <http://www.eceti.org/about-eceti.html>
- 278 <http://www.eceti.org/ufo--et-craft-photos--videos.html>
- 279 <https://www.youtube.com/watch?v=IcdqTBPppyQ>
- 280 <https://web.archive.org/web/20060117122343/http://www.eceti.org:80/files/DawnDV.mp4>
- 281 <https://web.archive.org/web/20060114164514/http://www.eceti.org/vidclips.htm>
- 282 <https://www.skyandtelescope.com/observing/celestial-objects-to-watch/observing-iridium-flares/>
- 283 <http://new.cseti.org/>
- 284 <http://new.cseti.org/cc5initiative.html>
- 285 <http://new.cseti.org/about.html>
- 286 <http://www.checktheevidence.com/wordpress/2017/11/20/9-11-holding-the-truth/>
- 287 <https://play.google.com/store/apps/details?id=org.cseti.ETContactTool&showAllReviews=true>
- 288 <https://home.socibd.com/>
- 289 <https://www.zersetzung.org/kt-books>
- 290 <https://www.zersetzung.org/www-karlturner-org>
- 291 <https://www.amazon.com/Communion-True-Story-Whitley-Strieber/>
- 292 <https://www.amazon.com/gp/product/0099616904/>
- 293 <https://www.bibliotecapleyades.net/cienciareal/cienciareal07.htm>
- 294 <https://www.amazon.co.uk/Interrupted-Journey-John-G-Fuller-ebook/dp/B00DRLFEDM>

-
- 295 [https://the-eye.eu/public/WorldTracker.org/UFO%27s/%281966%29 John Fuller - The Interrupted Journey - Two Lost Hours Aboard a Flying Saucer %28not OCR%29.pdf](https://the-eye.eu/public/WorldTracker.org/UFO%27s/%281966%29%20John%20Fuller%20-%20The%20Interrupted%20Journey%20-%20Two%20Lost%20Hours%20Aboard%20a%20Flying%20Saucer%20%28not%20OCR%29.pdf)
- 296 <http://ufomysteryandmeaning.blogspot.com/2012/09/interrupted-journey-case-of-betty-and.html>
- 297 <https://www.amazon.co.uk/flying-saucers-are-real/dp/B0000CHTYH>
- 298 https://www.youtube.com/watch?v=7Mmaz8A2V_o
- 299 <https://www.nicap.org/reports/hillmap.htm>
- 300 <http://zetatalk.com/>
- 301 <http://www.armaghplanet.com/blog/betty-hills-ufo-star-map-the-truth.html>
- 302 <https://www.imdb.com/title/tt0073834/>
- 303 <https://www.youtube.com/watch?v=vktFKa-8wg0>
- 304 <http://www.travis-walton.com/>
- 305 https://www.youtube.com/watch?v=g_LcA0N2uLY
- 306 <https://www.imdb.com/title/tt0106912/>
- 307 <https://www.goodreads.com/book/show/294285.Communion>
- 308 <https://youtu.be/P4fSCzT0yZl>
- 309 <https://www.astrosociety.org/education/astronomy-resource-guides/astronomical-pseudo-science-a-skeptics-resource-list/>
- 310 https://www.imdb.com/title/tt0776749/episodes?season=1&ref_=tt_eps_sn_1
- 311 <https://www.youtube.com/watch?v=8bbCTEW59GI>
- 312 <https://ufologie.patrickgross.org/htm/dechmontwoods79.htm>
- 313 <https://ufologie.patrickgross.org/sys/text.htm>
- 314 <https://www.youtube.com/watch?v=znTn5Tq9YSQ>
- 315 http://lyallsbookshop.co.uk/news_alan_godfrey.php
- 316 <https://www.facebook.com/alan.godfrey.5>
- 317 <https://youtu.be/jiHzys7uXHU?t=600>
- 318 <https://www.youtube.com/watch?v=jDC6NTptMdk>
- 319 <https://youtu.be/Wv7aFxnqYiQ?t=621>
- 320 <https://www.goodreads.com/book/show/3114814-lost-was-the-key>
- 321 https://www.goodreads.com/book/show/2509420.Unlocking_Alien_Closets
- 322 http://ufotrail.blogspot.com/2011/09/leah-haley-on-alien-abduction-it-doesnt_17.html
- 323 <https://www.youtube.com/watch?v=npY8yhShKjc>
- 324 <https://youtu.be/npY8yhShKjc?t=3443>
- 325 <https://ufocasebook.com/gulfbreeze.html>
- 326 <https://www.amazon.co.uk/Intruders-Budd-Hopkins/dp/0345346335>
- 327 <http://ufotrail.blogspot.com/2012/02/leah-haley-case-springfield-st-louis.html>
- 328 [http://ufotrail.blogspot.com/search/label/Leah Haley case?updated-max=2012-02-28T12:58:00-05:00&max-results=30&start=11&by-date=false](http://ufotrail.blogspot.com/search/label/Leah%20Haley%20case?updated-max=2012-02-28T12:58:00-05:00&max-results=30&start=11&by-date=false)
- 329 <http://ufotrail.blogspot.com/2012/02/leah-haley-case-springfield-st-louis.html>
- 330 <http://ufotrail.blogspot.com/2012/02/leah-haley-case-springfield-st-louis.html>
- 330 <http://www.constitution.org/abus/control.htm>
- 331 [http://www.checktheevidence.com/Disclosure/Audio/Stan Romanek 1.mp3](http://www.checktheevidence.com/Disclosure/Audio/Stan%20Romanek%201.mp3)
- 332 [http://www.checktheevidence.com/Disclosure/Audio/Stan Romanek 2.mp3](http://www.checktheevidence.com/Disclosure/Audio/Stan%20Romanek%202.mp3)
- 333 <https://web.archive.org/web/20031203000850/http://www.neilslade.com:80/ufos.html>
- 334 [http://www.checktheevidence.com/Disclosure/CD Menu/index.html](http://www.checktheevidence.com/Disclosure/CD%20Menu/index.html)
- 335 <https://www.amazon.co.uk/Messages-Worlds-Documented-Extraterrestrial-Contact/dp/0738715263/>
-

- 336 https://www.amazon.co.uk/Orion-Regressions-Stan-Romanek-ebook/dp/B007F81FR2/ref=pd_cp_351_1?_encoding=UTF8&pd_rd_ji=B007F81FR2&pd_rd_r=df1cc6ea-fb3a-11e8-a852-d9c80737ea8e&pd_rd_w=VKscU&pd_rd_wg=HxVVj&pf_rd_p=0ca7ef78-a9c4-4935-a8ff-59221f1ded3e&pf_rd_r=DT2D4RDS1PSEDN87VEMB&pssc=1&refRID=DT2D4RDS1PSEDN87VEMB
- 337 <https://www.amazon.co.uk/Answers-Stan-Romanek-ebook/dp/B0073M7W2W>
- 338 <https://www.amazon.co.uk/dp/B06XX5SPMY>
- 339 <https://web.archive.org/web/20040214183138/http://www.neilslade.com:80/Papers/Stn2003.html>
- 340 <http://www.checktheevidence.com/Disclosure/Video/RomanekUFO1.rm>
- 341 <http://www.checktheevidence.com/Disclosure/Video/RomanekUFO2.rm>
- 342 http://unicusmagazine.com/PDF/ABOVE_BLACK.pdf
- 343 <https://www.coasttocoastam.com/show/2002/01/02/>
- 344 <https://www.checktheevidence.com/wordpress/2017/09/24/book-climate-change-and-global-warming-exposed-hidden-evidence-disguised-plans/>
- 345 https://www.youtube.com/watch?v=Wc_gCqkyz9M
- 346 <https://www.youtube.com/watch?v=J30WGDq-AXU>
- 347 <https://www.youtube.com/watch?v=eOYmi5VxK8I>
- 348 <https://www.youtube.com/watch?v=97zuQJTrY6k>
- 349 <https://www.theufochronicles.com/2015/03/stan-romanek-update-trial-date-set-in.html>
- 350 http://www.reporterherald.com/news/loveland-local-news/ci_31526289/loveland-alien-abduction-author-stanley-romanek-sentenced-child-porn
- 351 <http://neilslade.com/Papers/UFOs.html>
- 352 <https://www.scholarsfor911truth.org/21-2/>
- 353 <https://www.checktheevidence.com/wordpress/2009/06/15/9-11-finding-the-truth-free-download-book/>
- 354 <https://www.youtube.com/watch?v=T3EieziJbY>
- 355 <http://neilslade.com/art/Brain/history.html>
- 356 <mailto:ns@neilslade.com>
- 357 https://www.snagfilms.com/films/title/paul_mccartney_really_is_dead_the_last_testament_of_george_harrison
- 358 https://www.goodreads.com/book/show/743974.Song_of_the_Greys
- 359 <https://www.amazon.co.uk/Orion-Regressions-Stan-Romanek/dp/061554844X/>
- 360 https://www.amazon.co.uk/gp/customer-reviews/R2WPHY00TSAHZ1/ref=cm_cr_dp_d_rvw_ttl?ie=UTF8&ASIN=061554844X
- 361 https://www.amazon.co.uk/Orion-Regressions-Stan-Romanek/dp/061554844X/ref=asap_bc?ie=UTF8
- 362 <https://www.drlwilson.com/ARTICLES/PSYCHOTRONIC.htm>
- 363 <https://www.britannica.com/topic/Elohim>
- 364 https://web.archive.org/web/20110809022039/http://www.intrudersfoundation.org/budd_hopkins.html
- 365 <http://thenightsky.org/nhp.html>
- 366 https://www.amazon.co.uk/Budd-Hopkins/e/B000APTPVK/ref=la_B000APTPVK_ntt_srch_lnk_2?qid=1545400285&sr=1-2
- 367 <https://www.amazon.com/Witnessed-Story-Brooklyn-Bridge-Abductions/dp/0671570315>
- 368 <https://youtu.be/Aw-LNg6tOdM>
- 369 <https://www.britannica.com/biography/Javier-Perez-de-Cuellar>
- 370 <https://www.ufocasebook.com/Manhattan.html>
- 371 <https://www.ufocasebook.com/daze.html>
- 372 <http://lindacortilecase.com/firsthand-eyewitness-yancy-spence.html>
- 373 <https://www.ufocasebook.com/dolanletter.html>

- 374 <https://youtu.be/oHxGQjirV-c?t=9252>
- 375 <https://www.exopolitics.org/was-un-secretary-general-abducted-by-aliens-in-1989-to-prevent-et-disclosure/>
- 376 <https://redstarfilms.blogspot.com/2005/05/greer-vs-woolsey.html>
- 377 <https://youtu.be/9OizRr9V7Z4?t=1300>
- 378 <https://www.youtube.com/watch?v=RR4rZ2bD8CE&t>
- 379 <https://www.checktheevidence.com/wordpress/2015/12/12/steven-greer-confirms-his-support-for-the-cover-up-of-911-evidence/>
- 380 <https://www.amazon.co.uk/Aliens-Scalpel-Roger-K-Leir/dp/1585091065>
- 381 <https://www.topsecretwriters.com/2012/04/alien-implants-roger-leir/>
- 382 <https://www.zersetzung.org/about-dr-karla-turner>
- 383 <http://www.viewzone.com/ebooks/KarlaTurnerTaken.pdf>
- 384 <https://www.amazon.co.uk/Captured-Betty-Barney-Hill-Experience/dp/1564149714>
- 385 <http://www.kathleen-marden.com/resources/TheMardenStonerStudyonCommonalitiesAmongAbductionExperiencers.pdf>
- 386 <https://www.amazon.co.uk/Alien-Abduction-Files-Startling-Reported/dp/1601632711>
- 387 <https://www.amazon.co.uk/Milabs-Military-Control-Alien-Abduction/dp/1881532186>
- 388 <http://www.alienjigsaw.com/gallery/Post-Alien-Abduction-Body-Marks.html>
- 389 <http://evelorgen.com/wp/articles/miscellaneous/tribute-to-barbara-bartholic/>
- 390 <https://www.thecosmicswitchboard.com/about-james/>
- 391 <http://theuniversaleducation.com/bartley/8/milab-operations>
- 392 <https://archive.org/details/TranceformationOfAmerica>
- 393 <http://trashcity.org/content/raising-arizona-wilder/>
- 394 <http://evelorgen.com/wp/articles/military-abduction-milabs-and-reptilians/milabs-a-pandoras-box/>
- 395 https://www.amazon.co.uk/Function-Orgasm-Condor-Books/dp/0285649701/ref=sr_1_1?s=books&ie=UTF8&qid=1551476671
- 396 <http://www.v-j-enterprises.com/montauk.html>
- 397 <https://www.youtube.com/watch?v=RbwvqVh-qWE>
- 398 <https://www.youtube.com/watch?v=AGglyC8QEnk>
- 399 <https://youtu.be/gxiBWv4xYE>
- 400 <https://sustainabledevelopment.un.org/content/documents/Agenda21.pdf>
- 401 <http://avalonlibrary.net/ebooks/JohnE.Mack.MID-Abduction-HumanEncounterswithAliens.pdf>
- 402 <http://www.drjudywood.com/articles/erin/>
- 403 <https://www.marshallsummers.com/>
- 404 <https://alliesofhumanity.org/allies1/>
- 405 <https://www.alliesofhumanity.org/10-point-allies-of-humanity-summary.pdf>
- 406 <https://www.marshallsummers.com/new-god/>
- 407 <https://youtu.be/AjqBdq2WMHM?t=1644>
- 408 https://www.amazon.co.uk/DMT-Molecule-Revolutionary-Near-Death-Experiences-ebook/dp/B072KT5BN2/ref=sr_1_1?s=books&ie=UTF8&qid=1544372095&sr=1-1&keywords=spirit+molecule+strassman
- 409 <http://www.ayahuasca-info.com/introduction>
- 410 https://www.vice.com/en_us/article/qbn8vq/ayahuasca-tourism-is-ripping-off-indigenous-amazonians
- 411 <https://botanicalshaman.com/2018/02/12/hallucinogens-used-by-shamans-in-religious-ceremonies/>
- 412 <https://ro.ecu.edu.au/cgi/viewcontent.cgi?article=2390&context=theses>
- 413 <http://www.angelfire.com/ut/branton/Schneider.html>

- 414 http://www.presidentialufo.com/old_site/ike&the.htm
- 415 <https://exopolitics.org/archived/Study-Paper-8.htm>
- 416 <http://whale.to/b/cooper.pdf>
- 417 <https://www.youtube.com/watch?v=V5tmogd9xp4>
- 418 <http://humansarefree.com/2015/08/bill-cooper-was-killed-shortly-after.html>
- 419 http://www.drjudywood.com/pdf/080128_94AffidavitLear.pdf
- 420 <http://www.ufocrashbook.com/artbio.html>
- 421 <http://www.ufocrashbook.com/eisenhower.html>
- 422 <https://www.youtube.com/watch?v=iv1ZCEiVrgg>
- 423 https://www.youtube.com/watch?v=2O_c_upHuKY
- 424 <https://www.youtube.com/watch?v=jxLkFRJUGxg>
- 425 <https://www.ufocasebook.com/emeneggersandler.html>
- 426 https://www.youtube.com/watch?v=L9_RnvHgLB8
- 427 <https://www.youtube.com/watch?v=sA5GpKcJ3zc>
- 428 <https://youtu.be/6CjDUA8LQg0?t=5303>
- 429 http://www.presidentialufo.com/old_site/disclosure_72-75.htm
- 430 <https://www.macfound.org/about/our-history/>
- 431 <http://www.disclosureproject.org/access/docs/pdf/DisclosureProjectBriefingDocument.pdf>
- 432 <https://www.secretnuclearbunker.com/>
- 433 <https://www.secretnuclearbunker.com/the-bunker-history/>
- 434 <http://www.ufos-alien.co.uk/cosmicrudloe.html>
- 435 https://www.bibliotecapleyades.net/sociopolitica/sociopol_pinegap08.htm
- 436 <https://www.amazon.co.uk/Underground-Bases-Tunnels-Government-Trying/dp/1939149266/>
- 437 <https://www.youtube.com/watch?v=O4o9xQYNbjc>
- 438 <http://www.theotherside.co.uk/tm-heritage/background/tunnel.htm>
- 439 <https://www.youtube.com/watch?v=zW5gklIKcDg>
- 440 https://www.bibliotecapleyades.net/sociopolitica/esp_sociopol_underground28.htm
- 441 <https://www.checktheevidence.com/wordpress/2014/02/11/edgar-fouche-disclosing-secret-technologies/>
- 442 <https://www.loc.gov/resource/hhh.ca2001.photos/?sp=4>
- 443 <https://www.youtube.com/watch?v=SdmUTR8uVDQ>
- 444 https://www.bibliotecapleyades.net/esp_dulcebook.htm
- 445 <https://exopolitics.org/archived/Dulce-Report.htm>
- 446 https://www.bibliotecapleyades.net/offlimits/offlimits_dulce04.htm
- 447 <https://www.youtube.com/watch?v=nfrjeDPROL4>
- 448 <https://www.redhill.net.nz/ufo/audio/u/UFOs and Aliens/Project Beta, The Story of Paul Bennewitz - Greg Bishop.pdf>
- 449 <https://www.youtube.com/watch?v=u7MbZfROZcO8>
- 450 <https://www.sandia.gov/>
- 451 <https://www.atlasobscura.com/places/starfire-optical-range>
- 452 <https://www.space.com/41202-new-adaptive-optics-produces-stunning-views.html>
- 453 <https://www.kirtland.af.mil/Units/AFRL-Directed-Energy-Directorate/>
- 454 <http://tinyurl.com/911ftb>
- 455 <http://www.ufohighway.com/>
- 456 <https://www.youtube.com/watch?v=CQWzXFhlaus>

- 457 <https://youtu.be/Nm9EcCBLv0Y?t=1333>
- 458 <https://cleantechnica.com/2008/08/14/hyperion-power-generation-announces-first-customer-letter-of-intent/>
- 459 <https://www.amazon.co.uk/Dulce-Truth-Evidence-Files-Valdez-ebook/dp/B00EI3X5V6>
- 460 [http://avalonlibrary.net/ebooks/Greg Valdez - Dulce Base - The Truth and Evidence from the Case Files of Gabe Valdez.pdf](http://avalonlibrary.net/ebooks/Greg%20Valdez%20-%20Dulce%20Base%20-%20The%20Truth%20and%20Evidence%20from%20the%20Case%20Files%20of%20Gabe%20Valdez.pdf)
- 461 <https://youtu.be/6CJdUA8LQg0?t=3267>
- 462 <http://radiomisterioso.com/2018/07/29/chris-lambright-x-descending-paul-bennewitz-and-the-air-force/>
- 463 <http://www.xdeskpublishing.com/books/x-descending/>
- 464 <https://apps.dtic.mil/dtic/tr/fulltext/u2/a432633.pdf>
- 465 <http://www.veritasradio.com/guests/2010/03mar/Vs-100312-bking.php>
- 466 <http://skinwalkerranch.org/timeline.html>
- 467 http://military.wikia.com/wiki/Dugway_Proving_Ground
- 468 http://www.aliendave.com/UUF0H_Underground.html
- 469 https://www.richplanet.net/richp_search.php?ref=175&part=1
- 470 <https://www.youtube.com/watch?v=t-tXOKDqtHc>
- 471 <https://www.youtube.com/watch?v=Vir83Qj1ZfI>
- 472 <https://www.youtube.com/watch?v=9gXQatlhPtc>
- 473 https://www.richplanet.net/richp_search.php?ref=15&part=1
- 474 [https://ia601007.us.archive.org/3/items/HiddenTruthForbiddenKnowledgeStevenM.Greer/Hidden Truth Forbidden Knowledge Steven M. Greer.pdf](https://ia601007.us.archive.org/3/items/HiddenTruthForbiddenKnowledgeStevenM.Greer/Hidden%20Truth%20Forbidden%20Knowledge%20Steven%20M.%20Greer.pdf)
- 475 <https://www.earthmagazine.org/article/travels-geology-pyramids-giza-wonders-ancient-world>
- 476 <https://www.lonelyplanet.com/peru/machu-picchu>
- 477 <https://www.ancient-code.com/5-ancient-petroglyphs-cave-paintings-depict-ancient-alien/>
- 478 <https://in5d.com/earths-quarantine-force-field-discovered-by-nasa/>
- 479 http://www.amazon.com/gp/product/B005KWQ5XE/ref=as_li_tl?ie=UTF8&camp=1789&creative=9325&creativeASIN=B005KWQ5XE&linkCode=as2&tag=in5d-20&linkId=L.M633XBPT74ERY7U
- 480 <https://www.history.co.uk/shows/ancient-alien/articles/ancient-alien-archaeological-evidence-0>
- 481 <https://www.ancientaliensdebunked.com/>
- 482 <http://truthbeknown.com/>
- 483 <https://metahistory.org/>
- 484 <https://www.archaeoastronomy.com/>
- 485 <https://keysofenoch.org/>
- 486 <http://www.ancient-wisdom.com/egyptastronomy.htm>
- 487 <https://coolinterestingstuff.com/ancient-pyramids-match-the-alignment-of-orions-belt>
- 488 <http://members.ozemail.com.au/~googong/giza11.html>
- 489 <http://gobeklitepe.info/>
- 490 <http://www.bosnianpyramid.com/>
- 491 <https://www.amazon.co.uk/Chariots-Gods-Erich-Von-Daniken/dp/0451490037/>
- 492 <https://www.ancient.eu/Sacsayhuaman/>
- 493 [http://www.daniken.com/en/index_htm_files/Bio of Erich von Daeniken.pdf](http://www.daniken.com/en/index_htm_files/Bio%20of%20Erich%20von%20Daeniken.pdf)
- 494 <https://www.youtube.com/watch?v=JU9CUia9GDw>
- 495 <https://spaceshipsofezekiel.com/>
- 496 <http://www.scriptural-truth.com/images/BookOfEEnoch.pdf>
- 497 [https://www.csicop.org/si/show/von_dauniken's_quos_chariots_a_primer_in_the_art_of_cooked_science](https://www.csicop.org/si/show/von_dauniken%27s_quos_chariots_a_primer_in_the_art_of_cooked_science)
-

- 498 <https://zoharstargate.com/legacynight/>
- 499 <https://www.starburstmagazine.com/reviews/erichvondanikenlegacynight>
- 500 <https://www.youtube.com/watch?v=ZV70EYwAJXk>
- 501 <https://chariotsofthegods.com/>
- 502 <https://earthsky.org/brightest-stars/sirius-the-brightest-star>
- 503 https://imagine.gsfc.nasa.gov/features/cosmic/nearest_star_info.html
- 504 https://www.amazon.co.uk/gp/customer-reviews/R2RI4ARFSI55XX/ref=cm_cr_dp_d_rvw_ttl?ie=UTF8&ASIN=0099257440
- 505 <https://www.drewexmachina.com/2017/04/06/new-hubble-observations-of-the-sirius-system/>
- 506 <https://archive.org/download/SaganIL/SaganIntelligentLife.pdf>
- 507 <https://www.ancientegyptonline.co.uk/denderatemplecomplex.html>
- 508 <http://mysterybabylon-watch.blogspot.com/2011/10/something-fishy-about-popes-hat.html>
- 509 http://3.bp.blogspot.com/-1InE1TKy_Ak/TqvNKdX6cnI/AAAAAAAAAic/ejEAV04J4UU/s1600/Dagon.jpg
- 510 <http://2.bp.blogspot.com/-l0YR17T-hqc/TqvN9Hqi5UI/AAAAAAAAAik/5WranEPMTiI/s1600/Oannes2.JPG>
- 511 https://www.bibliotecapleyades.net/vatican/esp_vatican138.htm
- 512 <http://www.absolutechinatours.com/china-travel/legends-of-fuxi-and-nuwa.html>
- 513 <http://www.templestudy.com/2008/09/17/nuwa-and-fuxi-in-chinese-mythology-compass-square/>
- 514 https://www.goodreads.com/book/show/274189.The_Christ_Conspiracy
- 515 http://articles.adsabs.harvard.edu/cgi-bin/nph-iarticle_query?1995A%26A...299..621B&data_type=PDF_HIGH&whole_paper=YES&type=PRINTER&filetype=pdf
- 516 <https://aasnova.org/2017/05/17/measuring-sirius-an-exercise-in-patience/>
- 517 <https://www.youtube.com/watch?v=1GJfjnw70T8>
- 518 <http://hyperphysics.phy-astr.gsu.edu/hbase/mod1.html>
- 519 <https://www.amazon.co.uk/Science-Dogon-Decoding-African-Tradition/dp/1594771332>
- 520 <http://www.holoscience.com/wp/the-madness-of-black-holes/>
- 521 <http://www.sitchin.com/>
- 522 <https://archive.org/details/B-001-000-340>
- 523 <http://www.lloydpye.com/>
- 524 <https://www.amazon.co.uk/Everything-You-Know-STILL-Wrong/dp/1522854452/>
- 525 https://www.bibliotecapleyades.net/sitchin/esp_sitchin_3a.htm
- 526 <https://zsitchinindex.wordpress.com/2013/11/14/interview-with-zecharia-sitchin-connecting-link-1993/>
- 527 <https://www.encyclopedia.com/arts/educational-magazines/sitchin-zecharia-1920>
- 528 <https://www.biblestudytools.com/dictionary/nephilim/>
- 529 <https://carm.org/what-are-nephilim>
- 530 <http://www.sitchinwrong.com/nephilim/nephilim.htm>
- 531 https://www.ancient.eu/The_Vedas/
- 532 <https://mythology.net/others/gods/el/>
- 533 <https://www.ancient.eu/amorite/>
- 534 <https://www.ancient.eu/article/225/enuma-elish---the-babylonian-epic-of-creation---fu/>
- 535 <http://www.sacred-texts.com/ane/enuma.htm>
- 536 <http://www.etana.org/node/581>
- 537 <https://www.ancient.eu/Marduk/>

-
- 538 <https://www.britannica.com/topic/Marduk>
- 539 <https://eprints.soas.ac.uk/12833/1/CUSAS-17-11.pdf>
- 540 <https://www.ancientpages.com/2018/12/28/controversial-5500-year-old-sumerian-star-map-of-ancient-nineveh-reveals-observation-of-kofels-impact-event/>
- 541 <http://www.sacred-texts.com/sym/mosy/mosy15.htm>
- 542 <https://www.promine.com/blog/5-oldest-mines-in-the-world-a-casual-survey>
- 543 <https://www.youtube.com/watch?v=a7pGRagwqW8>
- 544 <http://www.ancienttexts.org/library/mesopotamian/gilgamesh/>
- 545 <http://www.world-myth.com/mesopotamian/sumerian-creation-myth>
- 546 <http://godandscience.org/apologetics/gilgamesh.html>
- 547 <https://www.britannica.com/topic/agriculture/Earliest-beginnings>
- 548 <http://news.bbc.co.uk/1/hi/sci/tech/2982891.stm>
- 549 <http://www.sitchinistwrong.com/letter/letter.htm>
- 550 <http://www.sitchinistwrong.com/anunnaki/anunnaki.htm>
- 551 http://www.sitchinistwrong.com/ETCSL_Anunnaki_online_search/ETCSL_Anunnaki_online_search.html
- 552 <http://www.sitchinistwrong.com/VA243seal.pdf>
- 553 <https://faithlife.com/michael-heiser>
- 554 <http://www.abzu2.com/2016/04/06/zecharia-sitchin-inventing-the-nibiru-and-annunaki-lie-on-behalf-of-the-illuminati/>
- 555 <https://www.youtube.com/watch?v=Ij2ybmocVfo>
- 556 <http://tinyurl.com/sitsbook>
- 557 <https://web.archive.org/web/20100413065120/http://www.lloydpye.com/>
- 558 <http://www.elainemorgan.org/page14.html>
- 559 https://www.goodreads.com/book/show/33297.The_Naked_Ape
- 560 <http://www.elainemorgan.org/page2.html>
- 561 <http://www.elainemorgan.org/page15.html>
- 562 <https://www.youtube.com/watch?v=gwPoM7lGYHw>
- 563 <http://www.primitivism.com/aquatic-ape.htm>
- 564 <https://carta.anthropogeny.org/events/sessions/subcutaneous-fat-humans>
- 565 <http://www.reefreliefounders.com/science/2010/10/21/articlesafari-dolphin-dna-very-close-to-human/>
- 566 <https://www.laboratoryequipment.com/news/2017/02/diving-deep-dolphin-genome-could-benefit-human-health?empid=horizontalcontent>
- 567 <https://www.ncbi.nlm.nih.gov/pubmed/16263222?fbclid=IwAR11FcInJ3NBW1kPS9Hm0Ie-dCty9x8bBqIQfBHczS7WY6jCzCIYhpDoBPA>
- 568 <http://aquatic-human-ancestor.org/anatomy/kidneys.html>
- 569 <http://www.aquaticape.org/aahbook.html>
- 570 <http://www.elainemorgan.org/page9.html>
- 571 <http://www.macroevolution.net/about-me.html>
- 572 <http://www.macroevolution.net/human-origins.html>
- 573 <http://www.macroevolution.net/human-origins-2.html>
- 574 <https://www.thoughtco.com/the-domestication-of-pigs-170665>
- 575 <https://www.stolenhistory.org/threads/are-cheetahs-the-result-of-ancient-genetic-engineering.74/>
- 576 https://www.youtube.com/watch?v=zRx9w_4_IMM
- 577 <https://www.pnas.org/content/pnas/90/8/3172.full.pdf>
- 578 <https://laura-knight-jadczyk.com/books-by-laura-knight-jadczyk/>
-

- 579 <http://www.cassiopeia.org/>
- 580 <https://www.amazon.com/gp/search?ie=UTF8&keywords=9%2F11+ultimate+truth+jadczyk>
- 581 <https://laura-knight-jadczyk.com/2013/05/07/sott-talk-radio-no-ordinary-inside-job-the-911-psy-ops/>
- 582 <https://www.astronomyforbeginners.com/astronomy/messier-catalogue/>
- 583 <http://spider.seds.org/ngc/ngc.html>
- 584 <http://www.alien-revelations.com/2018/07/10/57-alien-races-confirmed-us-sergeant-clifford-stone/>
- 585 <http://tapnewswire.com/2017/04/richard-hall-analyses-david-icke-and-shapeshifting/>
- 586 <https://www.youtube.com/watch?v=ofaR4hCvVvY>
- 587 <http://www.lyricus.org/>
- 588 <http://wingmakers.com/>
- 589 <https://wingmakersblogeng.blogspot.com/2015/12/the-soul.html>
- 590 <http://www.wingmakers.com/>
- 591 <https://www.aliengigsaw.com/et-contact/Chace-What-Is-A-Reptilian.html>
- 592 <https://www.scribd.com/doc/205777185/A-Visual-Guide-to-Alien-Beings-BOOTLEG-EDITION-WatchZETTGEISTnow>
- 593 <https://www.isaackoi.com/alien-photos.html>
- 594 https://www.goodreads.com/book/show/199834.Unearthly_Disclosure
- 595 <https://ufologie.patrickgross.org/htm/caconi.htm>
- 596 <https://www.youtube.com/watch?v=EQl.98b2mWH0>
- 597 <http://archive.aviationweek.com/issue/19881121>
- 598 <http://forgetomori.com/2009/aliens/the-amoco-alien/>
- 599 <https://noriohayakawa.wordpress.com/2015/12/10/the-amoco-alien-a-classic-from-the-past-and-the-beginning-of-area-51-disinformation-campaign/>
- 600 <http://www.noufors.com/audio/Coast to Coast AM/Victor Interviewed by Art Bell.mp3>
- 601 <https://youtu.be/6nxWia0qSnk?t=1439>
- 602 <https://www.oni.navy.mil/>
- 603 <https://www.godlikeproductions.com/forum1/message1275393/pg1>
- 604 <https://www.amazon.co.uk/Area-51-Alien-Interview-Special/dp/B001D6AT70>
- 605 http://www.presidentialufo.com/old_site/donald_rumsfeld.htm
- 606 <https://www.youtube.com/watch?v=ZAVK91wcTIE>
- 607 <http://www.starchildproject.com/>
- 608 <https://www.youtube.com/watch?v=BAAnJneB4mk>
- 609 <https://web.archive.org/web/20041009172149/http://starchild-uk.com/>
- 610 <https://www.youtube.com/watch?v=kd0Ss1-ba6k>
- 611 <https://www.youtube.com/watch?v=9zzO4iRiobw>
- 612 <https://www.amazon.co.uk/Starchild-Genetic-Enigma-Human-Alien-Hybrid/dp/0979388147>
- 613 [http://avalonlibrary.net/ebooks/Lloyd_Pye_-_Starchild_Skull_Essentials_\(2011\).pdf](http://avalonlibrary.net/ebooks/Lloyd_Pye_-_Starchild_Skull_Essentials_(2011).pdf)
- 614 <https://www.youtube.com/watch?v=nguXc-NpyDI>
- 615 <http://www.starchildproject.com/what-is-the-starchild-skull>
- 616 https://www.youtube.com/watch?v=r1k_b-jmz3k
- 617 <https://alumni.harvard.edu/travel/leaders/david-aguiar>
- 618 <https://www.youtube.com/watch?v=pFWWwCduOaA>
- 619 <https://www.youtube.com/watch?v=k7HNXeGb86E>
- 620 <https://www.youtube.com/watch?v=fZkbh3g4G00>

-
- 621 <https://www.indiegogo.com/projects/help-this-skull-help-mankind>
- 622 <https://www.checktheevidence.com/wordpress/2017/05/23/the-starchild-project-keeping-the-record-straight/>
- 623 <http://www.veritasradio.com/>
- 624 <http://www.veritasradio.com/about.html>
- 625 <https://www.youtube.com/watch?v=7RbCHvQfO24>
- 626 <https://www.youtube.com/watch?v=0sRvj37gP5w>
- 627 <https://www.youtube.com/watch?v=IFQxFtNRYvA>
- 628 <https://www.youtube.com/watch?v=nNCKZxiGi54>
- 629 http://www.checktheevidence.com/cms/index.php?option=com_content&task=view&id=419&Itemid=62
- 630 <http://www.veritasradio.com/guests/2017/05may/Vs-170518-myong.php>
- 631 <http://www.starchildmelanieyoung.com/>
- 632 <http://www.theartofcloseencounters.com/>
- 633 <http://ia801505.us.archive.org/10/items/Vs170518MyongA2b/Vs-170518-myong-a2b.mp3>
- 634 https://www.theparacast.com/podcasts/paracast_070408.mp3
- 635 <http://www.checktheevidence.com/audio/Lloyd Pye - Starchild Skull - Richard Syrett - 15 Dec 2008.mp3>
- 636 <https://youtu.be/kd0Ss1-ba6k?t=9m42s>
- 637 <http://web.archive.org/web/20090116163853/http://starchildproject.com:80/team.htm>
- 638 <http://web.archive.org/web/20090116163827/http://starchildproject.com:80/history.htm>
- 639 <http://www.starchildproject.com/starchild-skull-history>
- 640 <https://youtu.be/l4TKCNKaJPQ?t=2h7s>
- 641 <https://youtu.be/5cnPEEgJrPo?t=4m>
- 642 <http://www.lloydpye.com/interveneonebook.html>
- 643 <https://youtu.be/nguXc-NpyDI?t=1h19m5s>
- 644 <http://www.veritasradio.com/guests/2013/12dec/Vs-131212-mbrownstein.php>
- 645 <https://www.starchildproject.com/single-post/2014/06/06/New-Hope-For-DNA-Testing>
- 646 <https://www.youtube.com/watch?v=h7LKPTxLpuA>
- 647 <https://boneclones.com/>
- 648 <http://www.starchildproject.com/dr-robinson-deformity-study>
- 649 <http://www.starchildproject.com/trace-genetics-dna-report>
- 650 <https://youtu.be/nguXc-NpyDI?t=1h9m54s>
- 651 <http://web.archive.org/web/20040603092133/http://starchildproject.com:80/SCSreport.PDF>
- 652 <https://www.starchildmelanieyoung.com/the-dna-results-are-in>
- 653 <https://thefieldreports.com.files.wordpress.com/2017/05/mt-dna-paleo-dna-labs-report.pdf>
- 654 <https://youtu.be/nguXc-NpyDI?t=1h26m42s>
- 655 <https://youtu.be/fZkbh3g4Go0?t=32m58s>
- 656 <https://www.youtube.com/watch?v=x9ty1GrkIh8>
- 657 <https://web.archive.org/web/20160204012530/http://www.starchildproject.com/>
- 658 <http://www.checktheevidence.com/audio/Melanie Young - Starchild Skull Hydrocephaly.mp3>
- 659 <https://www.starchildmelanieyoung.com/chase-kloetzke>
- 660 <http://www.chasekloetzke.com/about.html>
- 661 <https://youtu.be/CDvXLcwtKUE?t=42m>
- 662 <http://www.checktheevidence.com/audio/27 Sep 2017 - Podcast UFO - Martin Willis - Chase Kloetzke, UFO Investigations, Starchild Skull.mp3>
-

- 663 <http://siriusdisclosure.com/evidence/atacama-humanoid/>
- 664 <http://ufotrail.blogspot.co.uk/2014/06/dr-garry-nolan-talks-ata-starchild.html>
- 665 <https://thefieldreportscom.files.wordpress.com/2016/10/report.pdf>
- 666 <https://www.hindawi.com/journals/tswj/2013/734676/>
- 667 <https://www.starchildproject.com/1999-dna-report>
- 668 <https://ghr.nlm.nih.gov/gene/FOXP2>
- 669 <https://podcastufo.com/>
- 670 <http://www.checktheevidence.com/pdf/StarchildBooklet.pdf>
- 671 <https://www.youtube.com/watch?v=asheW-G-s9A>
- 672 <https://www.texasobserver.org/aliens-without-borders-exploring-the-del-rio-ufo-festival/>
- 673 <https://www.youtube.com/watch?v=LJnj8--Ft6I>
- 674 <http://www.checktheevidence.com/Misc/RE%20Melanie%20Young%20Correspondence%20-%20Sept%202017%20-Starchild.htm>
- 675 <https://thefieldreportscom.wordpress.com/2017/05/23/final-results-determining-if-the-starchild-skull-is-part-alien/>
- 676 <http://www.drjudywood.com/wp>
- 677 <https://www.checktheevidence.com/wordpress/2007/02/11/new-hijackers/>
- 678 <https://www.youtube.com/watch?v=hEND8dlUp1Y>
- 679 <http://web.archive.org/web/20060519071232/www.seaspower.com/whyseas.htm>
- 680 <https://web.archive.org/web/20071009142508/http://www.aero2012.com/en/index.mhtml>
- 681 <https://www.theparacast.com/podcast/june-22-2008-dr-steven-greer-and-jeremy-vaeni/>
- 682 [http://www.checktheevidence.com/audio/Dr Steven Greer - Orion and Aero 2012 - Paracast 22 Jun 2008.mp3](http://www.checktheevidence.com/audio/Dr%20Steven%20Greer%20-%20Orion%20and%20Aero%202012%20-%20Paracast%2022%20Jun%202008.mp3)
- 683 <https://web.archive.org/web/20080323232522/http://www.aero2012.com/en/orion.html>
- 684 <https://web.archive.org/web/20080310024051/http://www.aero2012.com/en/latestnews.html>
- 685 <http://www.aero2012.com/en/award.mhtml>
- 686 <https://web.archive.org/web/20080421124557/http://www.theorionproject.org:80/en/donate.html>
- 687 http://www.theorionproject.org/en/12_11_08_mailing.html
- 688 <http://video.google.com/videoplay?docid=871102105173074920>
- 689 <http://youtu.be/znCzJvN-cVI?t=4m46s>
- 690 <https://www.checktheevidence.com/wordpress/2013/05/06/getting-serious-about-sirius/>
- 691 <http://henrymakow.com/2013/04/Greer-the-Promise-of-Alien-Contact.html>
- 692 <http://www.imdb.com/name/nm0005048/>
- 693 http://siriusdisclosure.com/wp-content/uploads/2013/04/Chile-Specimen_GPN-Summary.pdf
- 694 <http://siriusdisclosure.com/wp-content/uploads/2013/04/signed-Lachman-report.pdf>
- 695 <http://paolov.wordpress.com/2013/05/04/atacama-alien-mystery/>
- 696 http://www.thelivingmoon.com/49ufo_files/03files2/Shuttle_Mission_STS_75.html
- 697 <http://www.youtube.com/watch?v=ZtMWNFhalSs>
- 698 <http://siriusdisclosure.com/ce-5-initiative/past-events/cseti-history/>
- 699 <http://youtu.be/cYPCKIL7oVw>
- 700 http://www.checktheevidence.co.uk/cms/index.php?option=com_content&task=view&id=286&Itemid=55
- 701 <http://www.thomastownsendbrown.com/>
- 702 <http://www.youtube.com/watch?v=gGjILrG3fL.Y>
- 703 <http://www.thmoray.org/>
- 704 <http://www.cheniere.org/>

- 705 <http://www.youtube.com/watch?v=MxsiCBzeYkw>
- 706 <http://archive.org/details/jfks19610427>
- 707 <http://www.youtube.com/watch?v=Px1t1-a9uxk>
- 708 http://www.checktheevidence.co.uk/cms/index.php?option=com_content&task=view&id=314&Itemid=55
- 709 <http://siriusdisclosure.com/orion-project/>
- 710 <https://vimeo.com/ondemand/unacknowledged>
- 711 <https://sirius-disclosure.myshopify.com/collections/unacknowledged>
- 712 <https://www.checktheevidence.com/wordpress/2017/12/10/unacknowledged-assisting-the-ufo-cover-up/>
- 713 https://www.youtube.com/watch?v=AmNzKxVwAYg&list=PLnrEt2fdZ0aBgPuVF0C_T1559YR20eDTc
- 714 https://www.richplanet.net/richp_genre.php?ref=249&part=1&gen=5
- 715 https://www.richplanet.net/richp_genre.php?ref=240&part=1&gen=5
- 716 https://www.richplanet.net/richp_genre.php?ref=247&part=1&gen=5
- 717 <https://www.ufocasebook.com/robertsonpanel.html>
- 718 <https://www.youtube.com/watch?v=Cc1IrnEkH0g>
- 719 https://www.richplanet.net/richp_genre.php?ref=190&part=1&gen=5
- 720 <https://vimeo.com/ondemand/dcbriefing>
- 721 <http://www.youtube.com/watch?v=4o4x6DJFXr0>
- 722 <http://web.archive.org/web/20080222044619/http://www.aero2012.com:80/en/risk.mhtml>
- 723 <http://www.disclosureproject.org/docs/pdf/disclosure911.pdf>
- 724 <https://youtu.be/oHxGQjirV-c?t=3h45m32s>
- 725 http://www.drjudywood.com/pdf/080324_SAIC_AffdJW91_150.pdf
- 726 http://files.shareholder.com/downloads/SAIC/0x0x208149/64117BC7-5895-497E-A8EB-158A6E57012C/AR_2004.pdf
- 727 <https://protected.networkshosting.com/depsor/DEPSpages/sponsors.html>
- 728 <https://digwithin.net/2014/06/04/andrews-and-saic/>
- 729 <http://aviationweek.com/awin/us-special-ops-command-psyops-related-contracts-go-saic-sycoleman-lincoln-group>
- 730 <http://www.disclosureproject.org/transcripts/JeanNoelBassior-Nov2005.htm>
- 731 http://www.bastison.net/RESSOURCES/Farce/57_Jones_Jesus.pdf
- 732 [https://archive.org/stream/HiddenTruthForbiddenKnowledgeStevenM.Greer/Hidden Truth Forbidden Knowledge Steven M. Greer_djvu.txt](https://archive.org/stream/HiddenTruthForbiddenKnowledgeStevenM.Greer/Hidden%20Truth%20Forbidden%20Knowledge%20Steven%20M.%20Greer_djvu.txt)
- 733 <https://www.bibliotecapleyades.net/disclosure/briefing/disclosure13.htm>
- 734 <https://www.youtube.com/watch?v=yytSNQ2ogD4>
- 735 <https://youtu.be/9OiZRr9V7Z4?t=1837>
- 736 <http://www.skyshipsovercashiers.com/articles11.htm>
- 737 https://www.nasa.gov/topics/people/features/von_puttkamer_obit.html
- 738 <https://www.youtube.com/watch?v=-Mc1AVR5PAU>
- 739 <https://www.youtube.com/watch?v=NIWFnBGvMPo>
- 740 <http://siriusdisclosure.com/cosmic-consciousness/>
- 741 <https://www.theguardian.com/world/2004/sep/25/usa.secondworldwar>
- 742 <https://www.c-span.org/person/?stevenschiff>
- 743 <http://www.theblackvault.com/documentarchive/the-roswell-incident/>
- 744 https://www.revolv.com/topic/Steven_Schiff
- 745 https://www.youtube.com/watch?v=YuQVeeZki_E
- 746 <https://www.youtube.com/watch?v=quuvi6Gvvmc>

- 747 <https://www.worldfinance.com/markets/the-history-of-the-rockefeller-family>
- 748 <http://redefininggod.com/2014/10/why-are-the-rockefellers-and-the-jesuits-guiding-the-ufo-disclosure-movement/>
- 749 <http://rockarch.org/bio/laurance.php>
- 750 <https://isgp-studies.com/ufo-disclosure-project-of-steven-greer>
- 751 <http://www.theangryufologist.us/dr-steven-greer-fraud-heres-proof/>
- 752 https://www.bibliotecapleyades.net/vida_alien/esp_vida_alien_27f.htm
- 753 <https://www.theufochronicles.com/2017/11/ufo-disinformation-agent-richard-doty.html>
- 754 <https://www.youtube.com/watch?v=ShZMgbXNSBs>
- 755 <https://www.earthfiles.com/2009/05/01/part-1-april-2009-chemistry-report-about-nano-thermitic-material-discovered-in-911-world-trade-center-dust/>
- 756 <https://www.earthfiles.com/2007/01/10/2006-usas-warmest-year-on-record/>
- 757 <https://www.coasttocoastam.com/show/2009/10/29>
- 758 <https://www.youtube.com/watch?v=2MZwh6p-OTw>
- 759 https://www.youtube.com/watch?time_continue=151&v=yR6EEPqzPeQ
- 760 http://www.checktheevidence.com/pdf/Stanton_Friedman_-_Cosmic_Watergate.pdf
- 761 <http://mysteriousuniverse.org/2017/07/peruvian-mummy-update-and-then-there-were-five/>
- 762 http://stantonfriedman.com/index.php?ptp=stans_bio
- 763 <http://stantonfriedman.com/index.php?ptp=articles&fdt=2002.12.15>
- 764 http://stantonfriedman.com/index.php?ptp=ufo_challenge
- 765 <https://www.youtube.com/watch?v=hOQoy0-Mhgs>
- 766 <http://news.bbc.co.uk/1/hi/world/americas/3707057.stm>
- 767 <http://www.paradigmresearchgroup.org/stephenbassett.html>
- 768 <https://paradigmresearchgroup.org/wordpress/2000/05/17/role-president-politics-disclosure-part-ii-case-george-w-bush/>
- 769 http://www.ufowatchdog.com/stephen_bassett.htm
- 770 <https://www.theparacast.com/?s=pyc>
- 771 <https://youtu.be/MCSpgjNjop0?t=21m40s>
- 772 https://www.youtube.com/channel/UCA9iiA4pxNRYxZDW_6oWbKw/videos
- 773 http://www.drjudywood.com/articles/NIST/Qui_Tam_Wood.shtml
- 774 <http://www.thehutchisoneffect.com/>
- 775 <http://www.johnbalexander.com/biography>
- 776 http://www.checktheevidence.com/audio/911/Steve_Bassett_on_911_-_UFO_Truth_Conf_-_29_Apr_2017.mp3
- 777 <https://youtu.be/mjG7DchEe2E?t=29m27s>
- 778 <https://www.dailystar.co.uk/news/weird-news/679045/Aliens-news-WW3-US-Russia-nuclear-weapons-ufo-video-Trump-Putin>
- 779 <http://www.imdb.com/name/nm0217691/bio>
- 780 <https://www.amazon.co.uk/Sekret-Machines-Tom-DeLonge/dp/1943272158>
- 781 <https://www.checktheevidence.com/wordpress/2017/10/13/will-tom-delonge-take-us-to-the-stars/>
- 782 <https://arstechnica.com/science/2018/10/all-the-dumb-things-blink-182-front-mans-ufo-project-37-million/>
- 783 <https://safireproject.com/project/team.html>
- 784 <https://www.youtube.com/watch?v=hNPBYtjyfZ0>
- 785 <https://youtu.be/RB43e95ZtdY?t=3828>
- 786 <https://www.youtube.com/watch?v=-gr-A4ebLeE>
- 787 <https://www.psychicnews.org.uk/articles/INSIDE-THE-MIND-OF-URI-GELLER/>

- 788 <https://www.youtube.com/watch?v=SU0Er8goVLs>
- 789 <https://www.youtube.com/watch?v=KtH-SxqdaA>
- 790 <https://tothestars.media/collections/sekret-machines>
- 791 <https://www.amazon.co.uk/Circular-Evidence-Investigation-Flattened-Phenomenon/dp/0747506353>
- 792 <https://www.amazon.co.uk/Secrets-Fields-Science-Mysticism-Circles-ebook/dp/B00BUAM6H4/>
- 793 <https://cropcircles.lucypringle.co.uk/photos/2014/apr.shtml>
- 794 <https://temporarytemples.co.uk/>
- 795 <https://www.bertjanssen.nl/cropcircles/photos.html>
- 796 <http://www.blresearch.com/otherfacts.php>
- 797 <https://oldcropcircles.weebly.com/uk-1678-hertfordshire.html>
- 798 <https://oldcropcircles.weebly.com/aerial-photography.html>
- 799 <https://web.archive.org/web/20130428020038/http://cropcirclesearch.homestead.com/1945-crop-circles.html>
- 800 <https://ufocasebook.com/tullysaucernest.html>
- 801 <https://youtu.be/zHPkuVxJr8A>
- 802 <https://oldcropcircles.weebly.com/uk-1971-warminster.html>
- 803 <http://www.world-destiny.com/grp1cc.html>
- 804
- <https://web.archive.org/web/20040620205914/http://easyweb.easynet.co.uk/~pppf6/Research/CropCircle/2003/CROPCIRCLE2003/Colin2003.html>
- 805 <https://cropcircles.lucypringle.co.uk/photos/1990/jul.shtml>
- 806 http://www.cropcirclesecrets.org/crop_circles_history90.html
- 807 <http://jimmyspage.co.uk/boleskinehouse.htm>
- 808 <https://www.scotsman.com/lifestyle/culture/music/aleister-crowley-s-inverness-mansion-destroyed-by-fire-1-3983595>
- 809 <https://cropcircles.lucypringle.co.uk/photos/2001/uk2001df.shtml>
- 810 <https://cropcircles.lucypringle.co.uk/photos/2009/uk2009bf.shtml>
- 811 <https://www.cropcircles.lucypringle.co.uk/photos/1996/uk1996ck.shtml>
- 812 <https://fractalenlightenment.com/15102/enlightening-video/benoit-mandelbrot-on-using-fractals-to-find-order-in-chaos/attachment/e7520001>
- 813 <http://www.cropcirclesearch.com/articles/distribution.html>
- 814 <http://www.cropcirclecenter.com/>
- 815 <http://cropcirclesdatabase.com/>
- 816 <http://www.lucypringle.co.uk/>
- 817 <https://www.rhs.org.uk/advice/profile?pid=158>
- 818 <http://www.colinandrews.net/Biography.html>
- 819 <http://www.colinandrews.net/Crop-Circles-BLT-Wrong.html>
- 820 <http://www.colinandrews.net/Greer-Pawelec-Testimony.html>
- 821 <https://www.checktheevidence.com/wordpress/2015/06/30/will-the-real-edgar-mitchell-please-step-forward/>
- 822 <https://www.checktheevidence.com/wordpress/?s=greer&submit=Search>
- 823 <http://www.blresearch.com/print/johnburke.html>
- 824 <http://www.openminds.tv/biophysicist-and-crop-circle-researcher-w-c-levegood-passes-1971/24370>
- 825 <http://www.blresearch.com/history.php>
- 826 <http://www.blresearch.com/published.php>
- 827 <http://www.blresearch.com/published/dispersion.php>

- 828 https://www.youtube.com/watch?v=_WQzNVaL8FI
- 829 <http://www.cropcirclesecrets.org/natgeo.html>
- 830 <http://www.blresearch.com/published/physics.html>
- 831 <https://www.britannica.com/science/red-sprite>
- 832 <http://www.lulu.com/shop/john-burke-and-kaj-halberg/seed-of-knowledge-stone-of-plenty/ebook/product-22952106.html>
- 833 <http://oxford.academia.edu/TerenceMeaden>
- 834 <https://www.youtube.com/watch?v=SDkj0Mfl3Ag>
- 835 <https://youtu.be/SIWsj0pMM5U?list=PL0D9FB8E7A0B72210&t=300>
- 836 <https://web.archive.org/web/20060214131209/http://www.phenomenonresearch.com/?page=articles&id=16>
- 837 <https://www.wherecanwego.com/item/e1178660/ecclesbourne-farmers-discussion>
- 838 <https://www.cropcirclesresearch.com/articles/e001-gizmo.html>
- 839 <http://www.colinandrews.net/PaulVigayPassing.html>
- 840 <https://cropcircles.lucypringle.co.uk/paul-vigay/>
- 841 <http://www.vigay.com/>
- 842 <http://www.true-facts.co.uk/911/>
- 843 <https://www.portsmouth.co.uk/news/mystery-of-man-found-dead-in-the-sea-1-1227531>
- 844 <https://www.telegraph.co.uk/news/newstopping/howaboutthat/ufo/7036018/Death-of-UFO-expert-Paul-Vigay-a-mystery.html>
- 845 <https://web.archive.org/web/20090302091705/http://sydwalker.info/blog/2009/02/27/suspicious-police-reaction-to-vijay-death/>
- 846 <http://www.cropcirclesresearch.com/articles/e024-dorchester.html>
- 847 <http://www.blresearch.com/robbert/vigay-kingston.php>
- 848 <https://isgp-studies.com/crop-circles-in-wiltshire-uk-and-us-real-or-not>
- 849 <http://menwhoconnedtheworld.weebly.com/new-11-today-september-9-1991.html>
- 850 <http://www.circlemakers.org/>
- 851 <http://www.circlemakers.org/tools.html>
- 852 <https://www.youtube.com/watch?v=9eh9q8gadas>
- 853 http://www.circlemakers.org/exhibit_a.html
- 854 <http://www.circlemakers.org/makeit.html>
- 855 <http://www.circlemakers.org/nike.html>
- 856 <https://www.youtube.com/watch?v=D9cGyMSLFRM>
- 857 <http://www.offkilter.co.uk/>
- 858 view-source:http://www.circlemakers.org/new_documents.html
- 859 http://www.circlemakers.org/new_documents.html
- 860 <https://www.companydirectorcheck.com/john-patrick-lundberg>
- 861 <https://www.youtube.com/watch?v=AErU25oKqSY>
- 862 <http://www.circlemakers.org/natgeo.html>
- 863 <http://www.circlemakers.org/amber.html>
- 864 <http://www.cmakers.org/alien.html>
- 865 <https://vimeo.com/298813944>
- 866 https://youtu.be/A9j_to9tbCE?t=492
- 867 <http://www.memorologyllc.com/CropCircleInfo/TheSignatureAndSignsOfContact-03.htm>
- 868 <https://www.cropcircles.lucypringle.co.uk/photos/2003/uk2003aq.shtml>
- 869 <https://youtu.be/z41yPmgkUJo?t=159>

-
- 870 <http://www.blresearch.com/plantab.php>
- 871 <http://www.procato.com/calculator-wavelength-frequency/>
- 872 <https://www.youtube.com/watch?v=i1aI8xtOYnk>
- 873 <http://www.blresearch.com/magnetic.php>
- 874 <http://www.blresearch.com/xrd.php>
- 875 https://serc.carleton.edu/research_education/geochemsheets/techniques/XRD.html
- 876 <https://www.youtube.com/watch?v=Ve4a6YBkDPs>
- 877 <http://www.adas.uk/Services>
- 878 <https://api.parliament.uk/historic-hansard/written-answers/1989/oct/17/cornfield-circles>
- 879 <https://www.coasttocoastam.com/show/2005/11/02>
- 880 <https://www.cropcircles.lucypringle.co.uk/photos/1994/uk1994er.shtml>
- 881 https://www.youtube.com/watch?v=vpav_VSqhUE
- 882 http://www.cropcirclesecrets.org/crop_circles_history94.html
- 883 <https://www.cropcircles.lucypringle.co.uk/photos/1999/uk1999do.shtml>
- 884 <http://www.martinkitel.net/cropcircles/e99/bcvideo.html>
- 885 <http://www.blresearch.com/eyewitness/eyewitness1.php>
- 886 <https://www.youtube.com/watch?v=Btptc0wyeQI>
- 887 <http://hessdalen.hiof.no/reports/hpreport84.shtml>
- 888 <https://www.youtube.com/watch?v=waBxph6jw2E>
- 889 http://hessdalen.hiof.no/reports/EMBLA_2002_2.pdf
- 890 <https://archive.org/details/ParanetContinuumShow86>
- 891 <http://www.colinandrews.net/CheesefootHd-SoundAnalysis.html>
- 892 <http://www.cropcirclesecrets.org/lectures.html>
- 893 <http://www.colinandrews.net/CheesefootHead-PatSection.html>
- 894 <https://www.youtube.com/watch?v=qoZIUUXEpnS>
- 895 <http://cns-alumni.bu.edu/~slechar/PhaseConjugate/PhaseConjugate.html>
- 896 <https://www.hindawi.com/journals/ijap/2010/564357/>
- 897 <https://youtu.be/Ve4a6YBkDPs?t=381>
- 898 <https://youtu.be/4dXutjodrUk>
- 899 <http://www.colinandrews.net/Biography-03.html>
- 900 <http://www.checktheevidence.com/audio2/CropCircles/ColinAndrews-CoastToCoast-Dec222005.mp3>
- 901 https://www.youtube.com/watch?v=x8aY-O7a_e8
- 902 https://duckduckgo.com/?q=military+helicopter+over+crop+circle&atb=v108-3&ia=videos&iai=x8aY-O7a_e8&pn=1
- 903 http://www.cropcircleanswers.com/scorpius_hour.htm
- 904 <https://www.space.com/19855-shoemaker-levy-9.html>
- 905 https://fr.edn.v5.futura-sciences.com/buildsv6/images/largeoriginal/9/4/4/94498af869_50083929_comet2-12.jpg
- 906 <https://www.psychedelicaventure.net/2009/07/2012-crop-circles-mayan-connection.html>
- 907 <http://cropcirclenirvana.co.uk/category/2004-aug-3-silbury-hill/>
- 908 <http://www.telegraph.co.uk/news/newstoppers/howaboutthat/5777580/Mayan-apocalypse-crop-circle-appears-at-Silbury-Hill.html>
- 909 <https://www.dailymail.co.uk/news/article-1300319/The-Holy-Trail-Crop-circles-Jesus-M4-spiritual-lift.html>
- 910 <http://www.dcca.nl/art/milkhill-uk.htm>
- 911 <http://www.world-destiny.com/scriptscc.html>
-

- 912 <http://www.cropcirclesearch.com/articles/arecibo.html>
- 913 <http://humansarefree.com/2011/02/two-most-important-alien-messages.html>
- 914 <http://www.enterprisemission.com/glyph.htm>
- 915 [https://www.chilbolton.stfc.ac.uk/Pages/Chilbolton-Advanced-Meteorological-Radar-\(CAMRa\).aspx](https://www.chilbolton.stfc.ac.uk/Pages/Chilbolton-Advanced-Meteorological-Radar-(CAMRa).aspx)
- 916 <https://cropcircles.lucypringle.co.uk/photos/2000/uk2000ce.shtml>
- 917 https://web.archive.org/web/20011018151012/http://www.seti.org/general/ao_message_crop.html
- 918 <http://www.enterprisemission.com/glyph2.htm>
- 919 <http://www.cropcirclesearch.com/articles/alienface.html>
- 920 <https://www.earthfiles.com/2002/08/19/winchester-hampshire-circular-code-analysis-updated/>
- 921 <http://yowusa.com/scp/maurice2004/1.shtml>
- 922 <https://youtu.be/TO2ObnOA7OU>
- 923 <http://yowusa.com/videos/maurice/1.shtml>
- 924 <https://www.smashwords.com/books/view/453284>
- 925 <http://www.earthfiles.com/news.php?ID=1480&category=Environment>
- 926 <http://www.paolaharris.com/AveburySept2008CrossAerialLo.htm>
- 927 <https://www.barnesandnoble.com/w/the-secret-space-program-maurice-osborn/1125098419>
- 928 <https://goo.gl/maps/Pwj91XFaXbr>
- 929 <https://i.ytimg.com/vi/nIOv53UB3Io/maxresdefault.jpg>
- 930 <http://www.circlemakers.org/richardjudy.html>
- 931 http://www.circlemakers.org/Img/big_rich_judy_02.jpg
- 932 <https://www.youtube.com/watch?v=lwdQL6fAus0>
- 933 <https://www.telegraph.co.uk/culture/4590866/Blackjack-Part-4.html?image=14>
- 934 <https://www.telegraph.co.uk/culture/4613223/Blackjack-Part-5.html?image=4>
- 935 https://www.reddit.com/r/conspiracy/comments/8twnw/messages_found_in_the_telegraphs_curious/
- 936 <https://www.mathsisfun.com/hexadecimals.html>
- 937 <http://www.asciitable.com/>
- 938 <https://www.rapidtables.com/convert/number/hex-to-ascii.html>
- 939 http://www.youtubeguide.net/images/ardentsentry_1425738i.jpg.gif
- 940 <http://cropcirclewisdom.com/crop-circle-diaries/category/ufton-crop-circle-2010-the-all-seeing-eye>
- 941 <https://plus.maths.org/content/os/latestnews/may-aug08/cropcircles/index>
- 942 <https://www.checktheevidence.com/wordpress/2015/12/18/energy-effects-and-residual-effects-in-crop-formations/>
- 943 <https://www.youtube.com/watch?v=g7jyQ7kzdw>
- 944 <http://www.journeyswithsoul.com/articles.php?id=19>
- 945 <https://youtu.be/ViwSDL657L4?t=2811>
- 946 <https://nationalmaglab.org/education/magnet-academy/watch-play/interactive/kelvin-water-dropper>
- 947 <http://www.busty-taylor.com/cropper/2004w001.htm>
- 948 <https://www.youtube.com/watch?v=Ska1egDqCUU>
- 949 <https://cropcircles.lucypringle.co.uk/photos/2002/uk2002bq.shtml>
- 950 <https://youtu.be/0PgKSjRogPk?t=366>
- 951 <http://www.nanoworld.org.ru/data/20041130/20051105/index.htm>
- 952 https://youtu.be/nd_c0poG-5M?t=819
- 953 <https://www.youtube.com/watch?v=wVTkaoYokRw>

- 954 <http://www.noufors.com/Documents/Books, Manuals and Published Papers/Specialty UFO Publications/Flying Saucer Review/FSR,1988,V 33,N 2.pdf>
- 955 <http://wirednewyork.com/forum/showthread.php?t=3577>
- 956 <https://www.youtube.com/watch?v=AaICfxxxRDk>
- 957 <http://www.drjudywood.com/articles/DEW/StarWarsBeam5.html>
- 958 <http://911thermitefree.blogspot.com/>
- 959 <https://www.checktheevidence.com/wordpress/2014/02/05/9-11-and-cold-fusion-a-possible-attempt-to-rewrite-history/>
- 960 http://911research.wtc7.net/essays/thermite/explosive_residues.html
- 961 <http://s18.photobucket.com/albums/b108/janedoe444/ARG/Image9.jpg>
- 962 <https://www.telegraph.co.uk/news/science/science-news/8671207/Crop-circles-created-using-GPS-lasers-and-microwaves.html>
- 963 <https://youtu.be/z41yPmgkUJo?t=475>
- 964 <https://youtu.be/XTE4dAJ4b40?t=263>
- 965 <http://www.colinandrews.net/Government-NickPope.html>
- 966 https://www.youtube.com/watch?v=H0_TG6S107A
- 967 <http://nickpope.net/paid-spokesperson.htm>
- 968 <https://www.dailymail.co.uk/sciencetech/article-2155885/Keep-eye-skies-saucers-Olympics-Games-warns-MoD-UFO-expert.html>
- 969 <https://ufodaily.wordpress.com/2012/07/23/the-end-of-nick-pope/>
- 970 <https://web.archive.org/web/20071011205804/http://www.nidsci.org/bios/vallee.php>
- 971 <https://buildfutureenergy.wordpress.com/2011/11/24/tedx-jacques-vallee-a-theory-of-everything-else-article-video-science-technology-news-information/>
- 972 <https://www.ourstrangeplanet.com/the-san-luis-valley/guest-editorials/jacques-vallee-interview/>
- 973 <http://www.checktheevidence.com/audio2/?dir=ET%20and%20UFO>
- 974 <https://web.archive.org/web/20041025222559/http://www.ufoevidence.org/researchers/detail13.htm>
- 975 <http://www.checktheevidence.com/audio2/ET and UFO/Jacques Vallee - UFOs etc - Coast To Coast AM - Feb 12 2008.mp3>
- 976 https://www.amazon.co.uk/dp/B00J4WWY9A/ref=dp-kindle-redirect?_encoding=UTF8&ctkr=1
- 977 <http://www.colinandrews.net/sitebuilder/images/1990-0710-DavidMichell-Dav-502x731.jpg>
- 978 <https://www.youtube.com/watch?v=Mwbyv1ANeLs&list=PL0D9FB8E7A0B72210>
- 979 <https://menwhoconnedtheworld.weebly.com/new-11-today-september-9-1991.html>
- 980 https://www.youtube.com/watch?v=a4e_wLLb_kk
- 981 <https://www.psychedelicaventure.net/2009/09/human-butterfly-biggest-crop-circle.html>
- 982 <https://vigilantcitizen.com/hidden-knowledge/origins-and-techniques-of-monarch-mind-control/>
- 983 http://colinandrews.net/Climate_Change.html
- 984 <https://www.checktheevidence.com/wordpress/2017/11/20/9-11-holding-the-truth/>